

AWARE
SERIES
All Wood—Almost Ready To Fly

HCAA2015

AVISTAR 40 ^{Mk II}™

RADIO-CONTROLLED SPORT/TRAINER AIRCRAFT

Assembly Manual



HOBBICO®

Entire Contents © Copyright, 1995

HCAZ3005 V 1.0

Congratulations!



Thank you for purchasing the Hobbico Avistar ARF! This all wood sport/trainer can be ready to fly in a fraction of the time it would take to build a conventional wood kit. It features a semi-symmetrical airfoil for a good combination of acrobatic performance and stability. With the help of a competent instructor, learning to fly the Avistar is easy and enjoyable. For the sport pilot, the acrobatic capabilities are far superior to basic trainers with flat-bottom wings.

KNOW YOUR MODEL'S PARTS.

Take a moment now to match the box contents with the items listed here. Following the Avistar assembly instructions will be quite easy if you identify and organize the parts before you begin.

Engine Mounting Parts	
Part#	Quantity
35	3mm nuts4
43	3 x 25mm machine screw.....4
44	3mm washers4
50	Push rods..... 2
53	3mm lock washers.....4
57	Pushrod guide tubes.....2



included at the back of this manual.

Please take your time and read through the instruction manual before starting to build your new airplane. If you have any questions, please feel free to give us a call at (217) 398-8970. We hope you enjoy building and flying the Avistar.

Replacement Parts Available

HCAA3020	Wing Kit	HCAA3022	Tail Set
HCAA3021	Fuselage Kit	HCAA3023	Landing Gear Set
HCAA3024	Wing Tip Set		

Tail Assembly	
Part#	Quantity
4	Horizontal stab and elevator.....1
5	Vertical fin and rudder.....1
25	Clevises.....2
26	Control horns2
29	Clear retaining tube.....1
30	Pushrods.....2
46	2 x 15mm machine screws4
55	Dorsal Fin1
56	Dorsal Fin Decal.....1

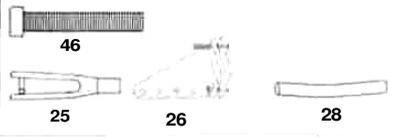

Wing Assembly	
Part#	Quantity
1	Right wing with aileron.....1
2	Left wing with aileron1
7	Plywood wing joiners.....3
19	Wing center tape1
21	Aileron servo tray.....1
22	Aileron servo tray mounting blocks.....2
23	Aileron control horns.....2
24	Threaded aileron pushrods.....2
25	Clevises2
26	Clear clevis retaining tube.....1
54	Wing alignment package.....1

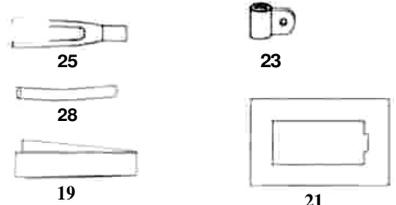

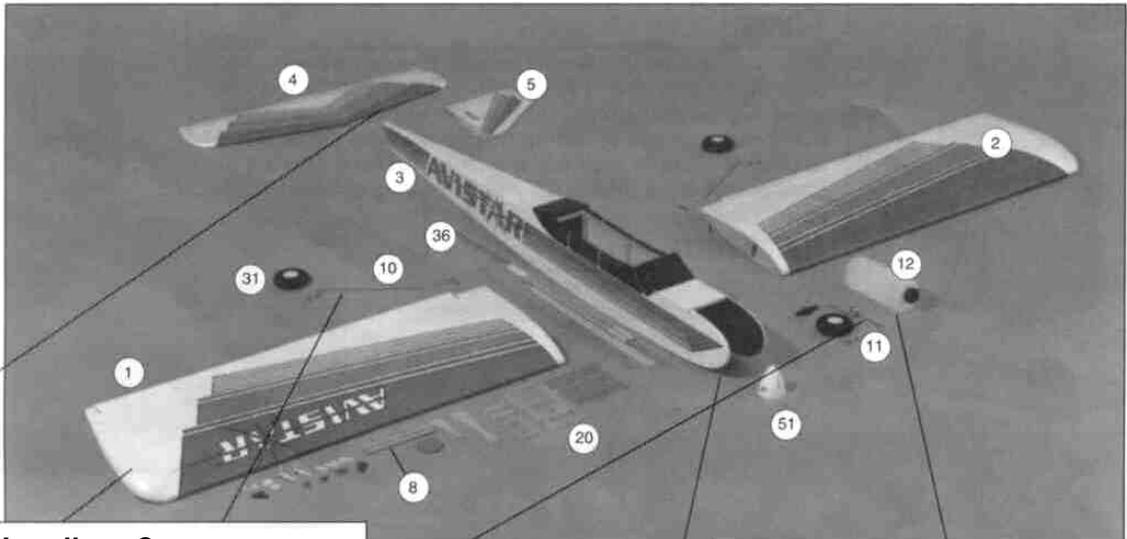

Landing Gear

Part#	Quantity
10	Main landing gear struts2
11	Nose gear strut1
27	Plastic Steering Arm.....1
29	Landing gear straps2
31	Wheels.....2
32	Wheel collars w/ set screws4
47	3 x 10mm sheet metal screws ...4
58	Pushrod connector2

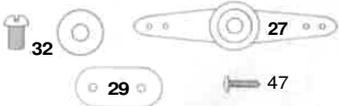

Fuel Tank & Parts

Part#	Quantity
12	Fuel tank.....1
19	Rubber tank stopper.....1
14	Fuel pick-up weight (clunk)1
15	Plastic stopper disks (one large and one small)2
16	Aluminum fuel tubing (one short and two long)3
17	3 x 18mm sheet metal screw1
18	Silicone Fuel line.....1
33	Foam tank collar1

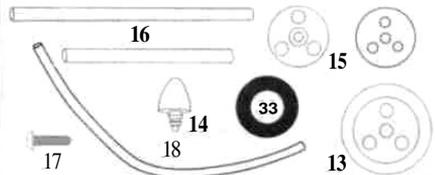

Fuselage & Parts

Part#	Quantity
3	Fuselage.....1
8	Wing mounting dowels.....2
20	Servo tray.....1
40	Plywood stab base.....1
51	Spinner.....1
52	Servo tray support.....1

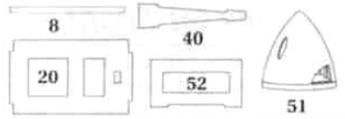

* Sketches shown are not actual size or to scale.

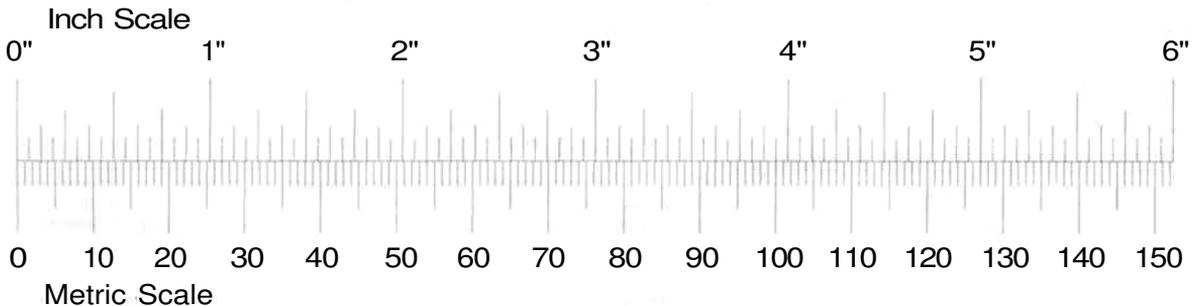

OTHER ITEMS YOU'LL NEED!



Glues

Choose a high quality 6-minute and 30-minute epoxy, such as Great Planes Pro Epoxy, which has been formulated especially for R/C model building. Pro Epoxies offer a strong bond and a variety of curing times suited for every step of assembly. You'll also need a thin, instant-setting CA (cyanoacrylate), a thicker CA+, plus rubbing alcohol for easy epoxy cleanup.



Hardware

Tools and accessories required for assembly include a hobby knife, small and large Phillips screwdrivers, needle nose pliers, drill with 1/16", 1/8", 11/64", 5/64", 3/32" and 5/32" bits, ruler, #64 rubber bands, 1 foot of medium fuel tubing, and petroleum jelly.

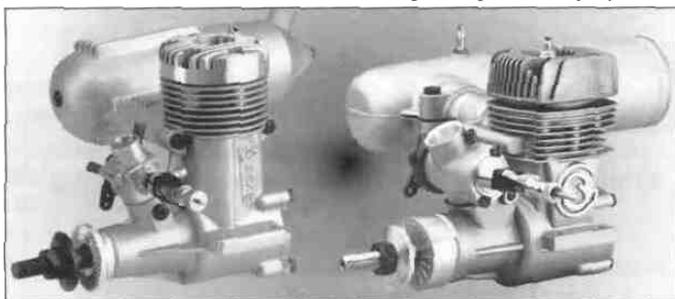

Model Engine

Power your Avistar with any high-quality, .40-size model engine. The O.S. .40 FP or Super Tigre GS-40 are fine engines for this plane. Look for features such as easy break-in, easy starting, efficient carburetion and low maintenance. Check the manufacturer's recommendations for propellers to use with your engine.

Radio Equipment

To control your Avistar's "flight path," you'll need a 1991 legal 4-channel aircraft radio system with four standard servos. Many 4-channel radios include just three. You may need to purchase the fourth separately, Hobbico Command servos are available singularly and will work great for this plane. The servos, battery pack, and radio receiver will be mounted on-board your model and need to be cushioned from jolts and vibration. Half-inch thick foam rubber sheets (BCAQ1050) are available for this purpose.

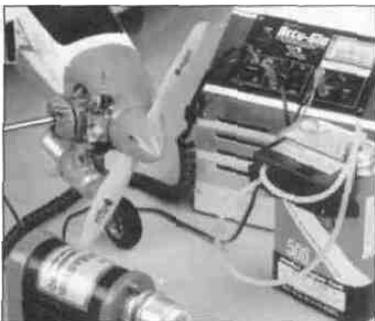
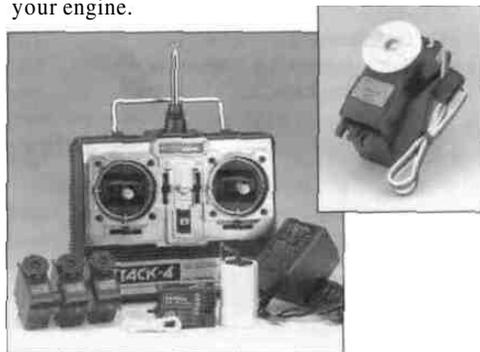

Getting Ready for Flight

Your Hobbico Avistar can be ready for takeoff in as little as 20 hours. Your hobby dealer or flying instructor (see next page) can help you decide what accessories you'll need for flight. Most are one-time-only purchases - like a glow plug igniter (see glossary), fuel pump, and "chicken stick" or electric starter. You will also need to obtain model glow fuel. Use glow fuel with a 10-15% nitro content to keep your engine performing at its peak.

Other General Items Required

Epoxy Brushes (GPMR8062)
FoamKubber(HCAQ1050)
Felt tip Pen
Masking Tape
Z-Bend pliers (Optional)
Wire Cutter

Mixing Sticks (GPMR8055)
Phillips Screwdriver
Sanding Block w/ 150 grit paper
Medium Fuel Tubing (GPMQ4131)
Rubbing Alcohol

Clothespins
String
Adjustable Wrench
Paper Towels
"1" Pins

FIND A FLYING INSTRUCTOR

If you're a beginner, the best way to begin flying your Avistar is with an experienced R/C pilot or flying instructor at your side. You'll learn faster, and avoid risking your model before you're truly ready to solo.

Where do you find an instructor? Ask at your local hobby shop. They'll have information about flying clubs in your area whose membership includes qualified instructors. You should also join the Academy of Model Aeronautics (AMA), a 165,000 member-strong

national organization with more than 2,300 chartered clubs across the country. Through any one of them, instructor training programs are available. Contact the AMA at the address or phone number below:

Academy of Model Aeronautics
5151 East Memorial Drive
Muncie, IN 47302-9252
(800) 435-9262



WARNING! THIS IS NOT A TOY!

PLEASE FOLLOW THESE SAFETY PRECAUTIONS:

Before you fly:

1. Make sure that no other fliers are using your radio frequency.
2. Your radio transmitter must be the **FIRST** thing you turn ON, and the **LAST** thing you turn OFF.
3. Double check all control surfaces, making sure they are secure and move in the proper direction.
4. Make sure that the transmitter & receiver batteries are fully charged.

Fuel storage and care:

1. Do not smoke near your engine or fuel.
2. Store all engine fuel in a safe, cool, dry place, away from children and pets. Model fuel will evaporate, so make sure that you always store it with the cap secure.

When starting and running your engine:

1. Always wear safety glasses.
2. Make certain that your glow plug clip is securely attached to the glow plug and cannot pop off, possibly falling into the spinning propeller.
3. Use a "chicken stick" or electric starter to start the engine - **NOT** your fingers.
4. Make sure that the wires from your starter and glow plug clip cannot become tangled with the spinning propeller.
5. Do not stand at the side of the propeller when you start or run the engine. Even at idle speed, the spinning propeller will be nearly invisible.
6. If any engine adjustments are necessary, approach the engine only from behind the spinning propeller.

90-Day Limited Warranty

If you, as the original owner of this model, discover a defect in parts or workmanship within 90 days of purchase, Hobby Services will repair or replace it - at the option of our authorized U.S. repair facility, Hobby Services - without charge. Our liability does not include cost of shipping to us. However, Hobby Services will pay shipping expenses to return your model to you.

You must provide proof of purchase, such as your original purchase invoice or receipt, for your model's warranty to be honored.

This warranty does not apply to damage or defects caused by misuse or improper assembly, service or shipment. Modifications, alterations or repair by anyone other than Hobby Services voids this warranty. We are sorry, but we cannot be responsible for crash damage and/or resulting loss of kits, engines, accessories, etc.

Repair Service

Your Avistar must be returned directly to Hobby Services for warranty work. The address is:

Hobby Services, Attn: Service Department, 16) Interstate Drive, Champaign, IL 61821-1067 Phone: (217) 398-0007, or for product information and technical support please contact us at (217) 398-8970

Please follow the instructions below when returning your model. I his will help our experienced technicians to repair and return it as quickly as possible.

1. **ALWAYS** return your entire system, including airplane and radio.
2. Disconnect the receiver battery switch harness and make sure that the transmitter is turned off. Disconnect all batteries and drain all fuel.
3. Include a list of all items returned and a **THROUGH** written explanation of the problem and service needed. If you expect the repair to be covered under warranty, also include your proof of purchase.
4. Include your full return address and a phone number where you can be reached during the day.

If your model is past the 90-day warranty period or is excluded from warranty coverage, you can still receive repair service through Hobby Services at a nominal cost. Repair charges and postage may be prepaid or billed COD. Additional postage charges will be applied for non-warranty returns. All repairs shipped outside the United States must be prepaid in U.S. funds only.

All pictures, descriptions and specifications found in this instruction manual and on the product package are subject to change without notice.

ASSEMBLING THE WING

Special Note:

You should charge your radio system before starting to build. Following the manufacturer's directions, connect your transmitter and receiver batteries to the system's charger. This way the radio will be ready when it is time to install and test the components.

both sides of one of the wing joiners. Sandwich this coated joiner **between** the remaining two. Quickly proceed through the following steps (3 and 4) before the glue cures.

Prepare the wing joiners

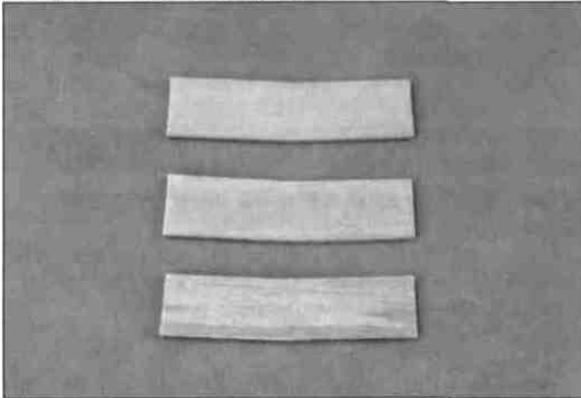

❑ 1. Locate the 1/8" (3mm) die-cut **plywood** wing joiners. Arrange the three "V-shaped joiners in the same orientation as they will be glued together. Sand off any bumps from the edges.

Remove the excess epoxy



❑ 3. Excess epoxy will squeeze out of the seams between the joiners and must be removed *before* the epoxy is allowed to cure. Use a paper towel to remove the excess epoxy.

Glue the wing joiners

Note: Please read steps 2 through 4 before gluing.



❑ 2. Mix approximately 1/4 oz. (7.5ml) of 30-minute epoxy using a mixing stick and a cup. Using a mixing stick or epoxy brush, apply an even coat of epoxy on

Clamp the wing joiner

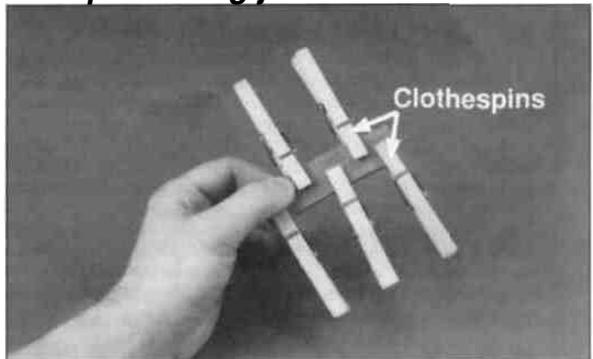

❑ 4. Use clothespins to clamp the wing joiners firmly together. If any more epoxy squeezes out, remove using a paper towel. Make sure the joiners are evenly lined up with each other, set this aside until fully cured.

Mark the centerline on the joiner

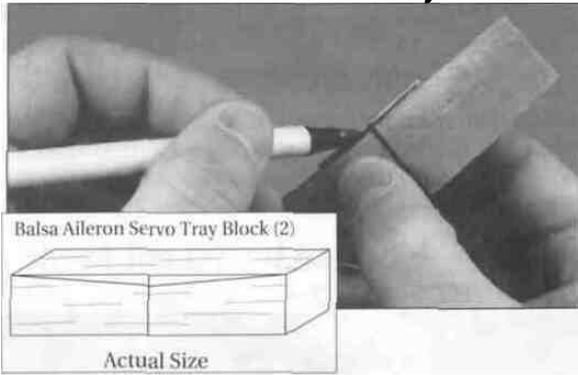

❑ 5. After the epoxy has cured and the clothespins have been removed, draw a centerline on both sides of the plywood wing joiners and the two balsa $5/16$ " square x $1-7/16$ " (8mm square x 36mm) aileron servo tray mounting blocks. Use the plywood joiner as a template to mark the wing dihedral angle on both of the balsa aileron servo tray mounting blocks. Put the balsa blocks aside for use in later steps.

Even the edges



❑ 6. Using a flat sanding block or similar tool, sand the wing roots so they will seat together with no gaps. Do not sand too much or the dihedral angle could change.

Mark the wing cavity

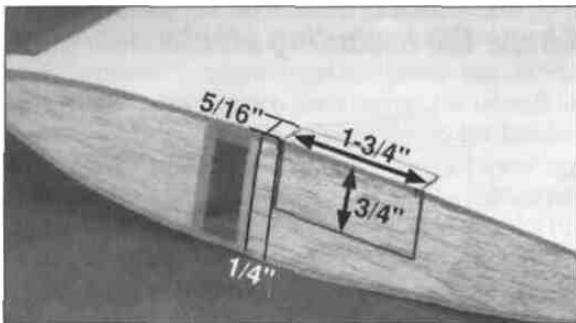

❑ 7. Mark the aileron servo location on both wing panels using a felt tip pen. Using a hobby knife, cut an opening into the panels following the lines you just drew.

Trial fit the wing joiner

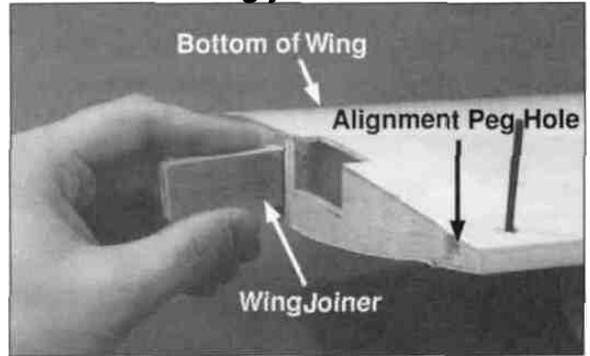

❑ 8. Trial Fit the wing joiner in **both** wing panels by sliding the joiner into the joiner cavity in the wing. The joiner should slide in with little resistance up to the centerline. Also trial fit the 3.6mm x 4mm x 25mm **wing alignment peg** into the holes at the trailing edge. If the wing joiner will not fit in the cavity, lightly sand any excess epoxy or uneven surfaces from the joiner edges, sides and ends. **Caution: A snug fit is desirable between the joiner and the wing cavity. Do not sand excessively.**

Viewing the wing dihedral

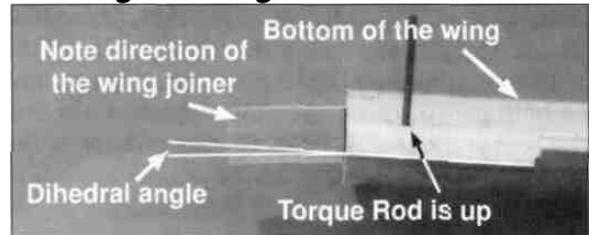

❑ 9. Pay close attention to the orientation of the wing joiner in relation to the wing panel, creating the dihedral angle as shown. Trial fit the wing panels together. They should fit flush against each other with no gaps.

NOTE: When performing the following steps, be sure to use a sufficient amount of epoxy to form a complete and solid bond between the plywood wing joiner and the two wing halves. This is the most important glue joint the entire airplane.

Please read through the following three steps before mixing any epoxy. You must complete these steps within 20 minutes from the time you mix the epoxy.

Glue the joiner

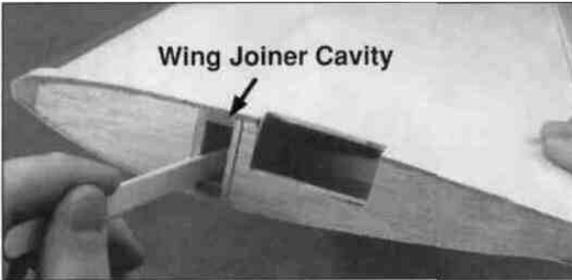

❑ 10. Mix 1/2oz. (15ml) of 30-minute epoxy. Use a mixing stick or epoxy brush to apply epoxy to all four sides of the joiner cavity wall. Insert the joiner into the cavity up to the centerline marked on the joiner plate. Be sure you are installing the joiner correctly. Quickly proceed to the next step.

Apply epoxy to the wing root rib

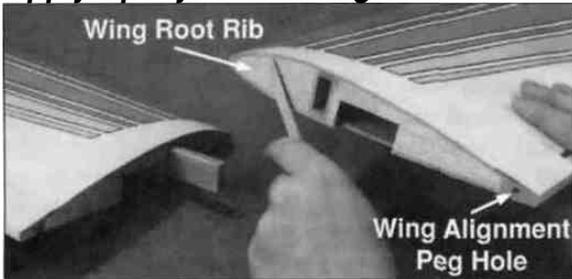

❑ 11. Apply epoxy inside the joiner cavity of the remaining wing panel. Next, coat the wing root ribs on both panels. Insert the wing alignment peg into the hole at the trailing edge. Quickly proceed to the next step.

Join the wing halves

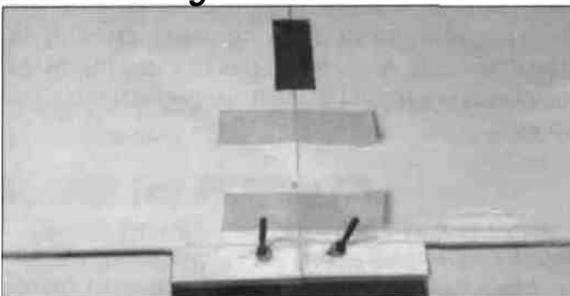

❑ 12. Assemble the two wing halves with the tightest seam possible. No gaps should be showing between the two wing halves. Clean any excess epoxy from the

outside of the wing using a paper towel dampened with rubbing alcohol. Use several strips of masking tape on both sides to hold the wing halves tightly together. Let the epoxy fully cure.

Trim the covering

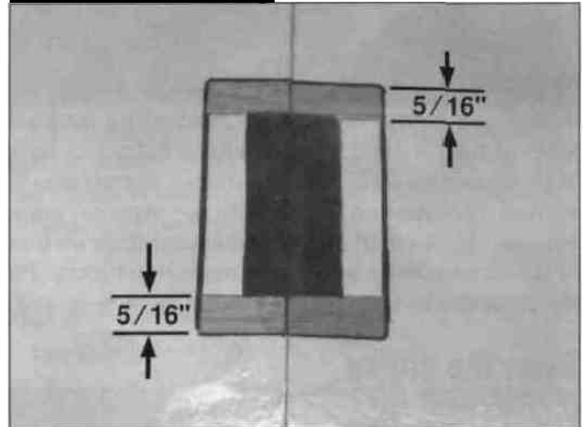

❑ 13. Hold the plywood aileron servo tray over the hole in the bottom of the wing. Trace the outside of the tray with a felt tip pen and then remove the tray from the wing. Draw two lines 5/16" from the ends as shown. Carefully remove only the covering within the lines using a new #11 blade in a hobby knife, being careful not to cut into the balsa wing sheeting.

Shape the mounting blocks

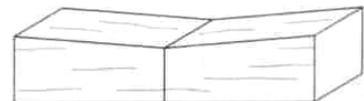

❑ 14. Locate the two balsa servo tray mounting blocks (marked earlier in step #5 page 7) and position them with the marked dihedral line up. Cut or sand the marked angle out of the block. This angled side will be placed against the wing when the servo tray is installed.

Assemble the servo tray

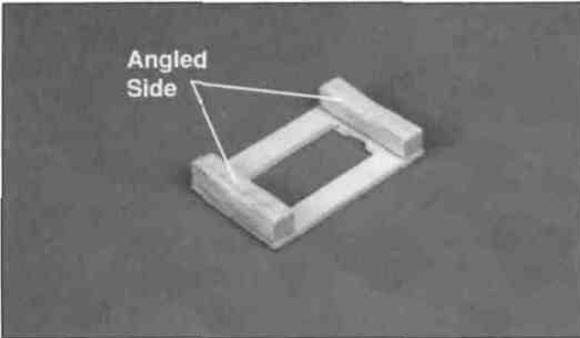

- ❑ 15. Glue the balsa aileron servo blocks onto the servo tray so that the angled side you just cut is facing away from the plywood tray.

Trial fitting the aileron servo

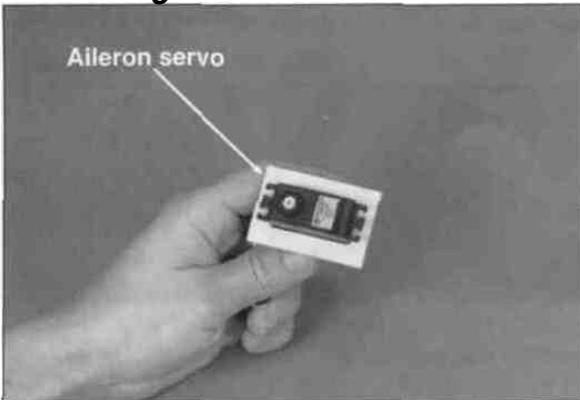

- ❑ 16. Trial fit the aileron servo into the servo tray and the hole in the bottom of the wing. Enlarge either hole, if needed, with a hobby knife or a fine-toothed file until a proper fit is achieved. The plywood tray should not actually contact the servo. Leave a 1/64" gap all the way around. Remove the servo.

Install the servo tray

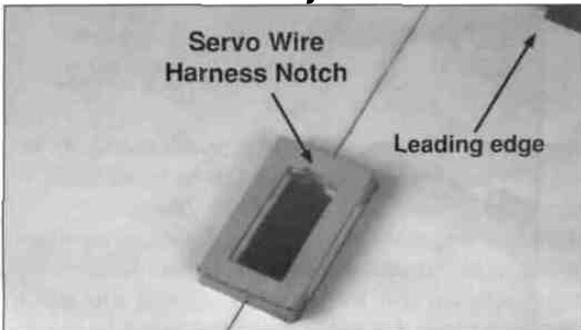

- ❑ 17. Mix 1/8oz. (3.5ml) of 6-minute epoxy to glue the servo tray to the bottom side of the wing. Apply

equal amounts of epoxy to the mounting blocks on both ends of the servo tray. Attach the servo tray to the bottom of the wing with the servo wire harness notch facing the leading edge of the wing. Allow the epoxy to fully cure before proceeding to the next step.

Apply the center tape

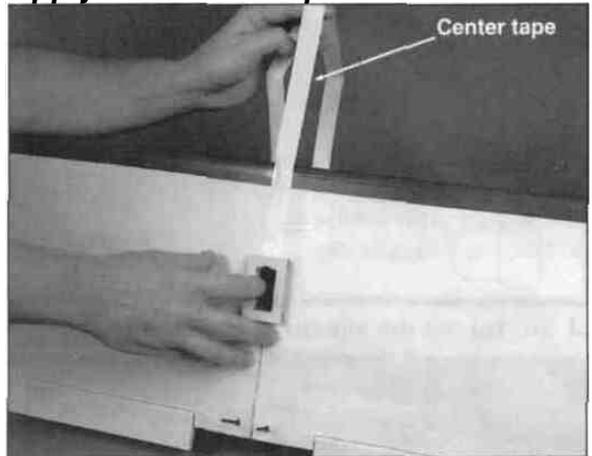

- ❑ 18. Starting at the front of the aileron servo tray, apply the 1/2" (12.5mm) white wing center tape completely around the wing over the joint. A small amount of pressure should be applied to make a smooth seam.

Check the aileron hinge



- ❑ 19. Gently tug on each of the ailerons at each hinge location. If any of the hinges are loose, reglue them as described here. First, flex the surface all the way one direction (DO NOT REMOVE THE AILERON). Apply 5 drops of thin CA onto each hinge. Use a paper towel to absorb any excess glue. Wait a few minutes for the glue to harden, then flex the surface the other direction and glue the other side of the hinges in the same manner. Finally, flex back and forth several times to free up the aileron.

Install the aileron control horns

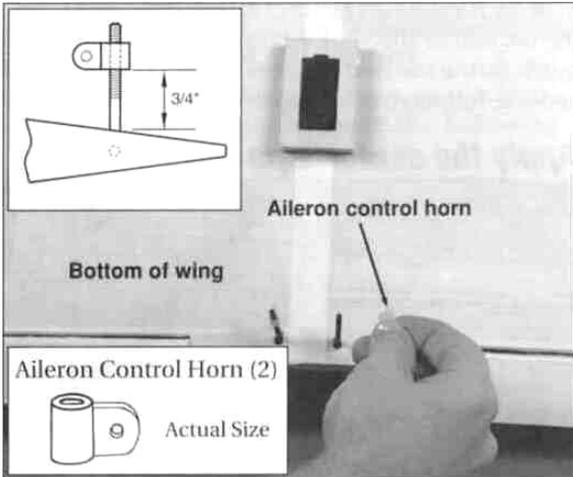

- ❑ 20. Thread the aileron control horns onto the torque rods until there is 3/4" (19mm) of torque rod between the wing and control horns.

Assemble the pushrods

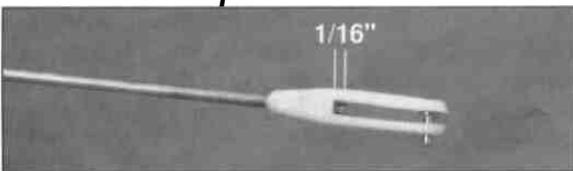

- ❑ 21. Locate two plastic clevises and two 8" (203mm) aileron pushrods. Thread the clevises onto the threaded end of the pushrods until the rod begins to protrude inside of the clevis between the forks.

Install the pushrods

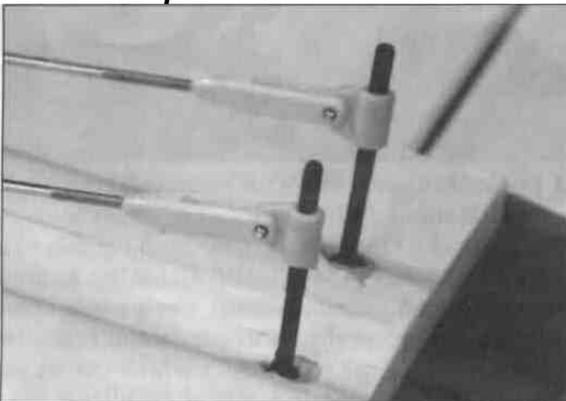

Securing the aileron pushrods

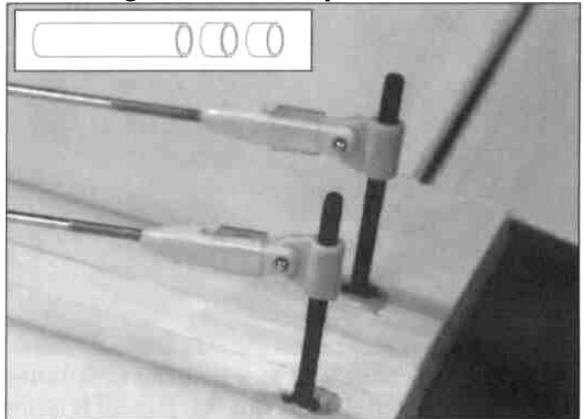

- ❑ 23. Locate the 1/4" (6.5mm) diameter clear retaining tube and cut two 1/4" (6.5mm) pieces. Slide one piece onto each clevis to secure the connection between the clevis and the horn.

This concludes the wing assembly for now. Tape the pushrods to the wing to keep them in place until you install the servo.

FUSELAGE ASSEMBLY

Locate the wing dowel holes

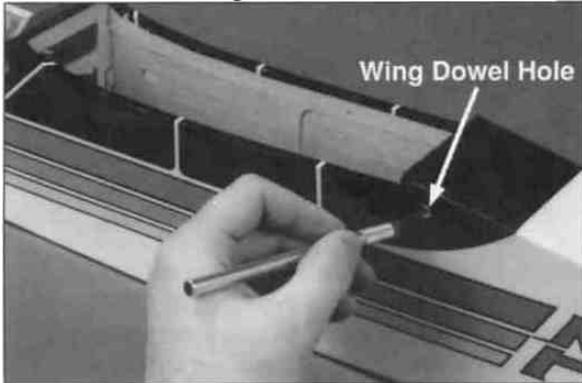

- ❑ 1. Locate the four round holes, two on each side of the fuselage, and remove the covering over each hole. **Caution: Do not cut out the rectangular holes in the side of the fuselage.**

Install the wing dowels

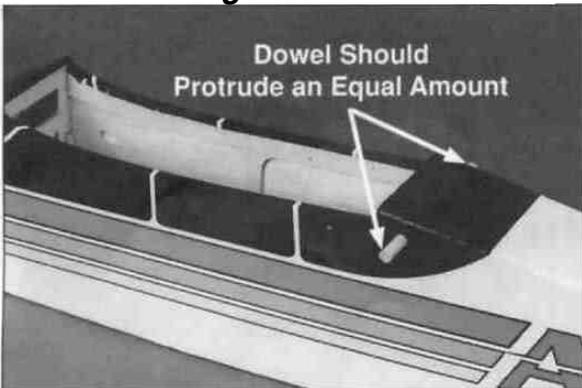

- ❑ 2. Insert both wing mounting dowels so they protrude an equal amount on both sides. Mix 1/4oz. of 30-minute epoxy. Apply glue around the dowels next to the fuselage and rotate them in and out to help force the glue into the holes. Using a paper towel, spread the excess glue around the ends of the dowels. This will fuelproof and add strength to the wood. From the inside of the fuselage, apply more epoxy around the dowels where they meet the sides. These wing dowels will be used as anchors for rubber bands to hold the wing in place.

Locate the stabilizer slot

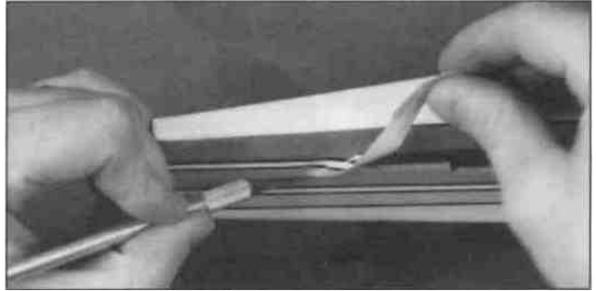

- ❑ 3. Locate the horizontal stabilizer slot under the covering on the tail section of the fuselage by pressing lightly with your finger. The slot is located on both sides of the tail. Using a hobby knife, carefully remove the covering, exposing the slots. **NOTE: Do not cut into the wood around the slot.**

Install the plywood stabilizer mount

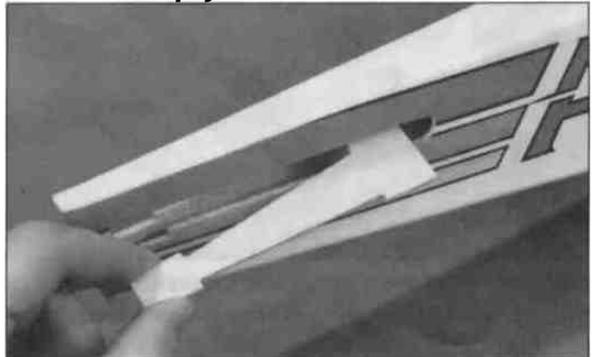

- ❑ 4. Locate the 1/8" (3mm) plywood stabilizer mounting base and trial fit it into the bottom of the horizontal stabilizer slot. Lightly sand the base if necessary to obtain a good fit. Remove the base from the fuselage.

Glue the mount in place

- ❑ 5. Mix 1/8oz. (3.5ml) of 30-minute epoxy. Using a mixing stick, apply a generous amount of glue into the slot and position the stabilizer mounting base firmly in position. Remove any excess epoxy that remains on the top of the stabilizer base and on the outside of the fuselage.

Remove the tail post

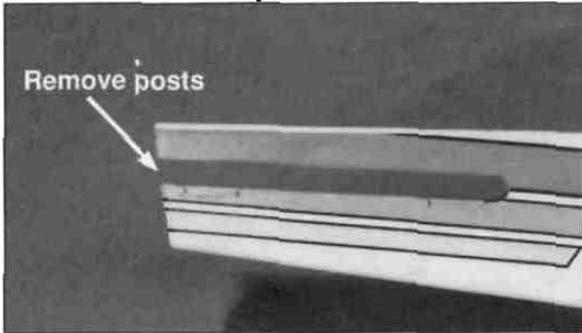

❑ 6. Located at the rear of the fuselage, behind the horizontal stabilizer slot, are the balsa tail posts. These posts were left for manufacturing alignment. The posts must be removed in order to insert the horizontal stabilizer. Using a sharp hobby knife or razor saw, cut the posts even with the slot as shown in the picture.

Locate the vertical fin slot

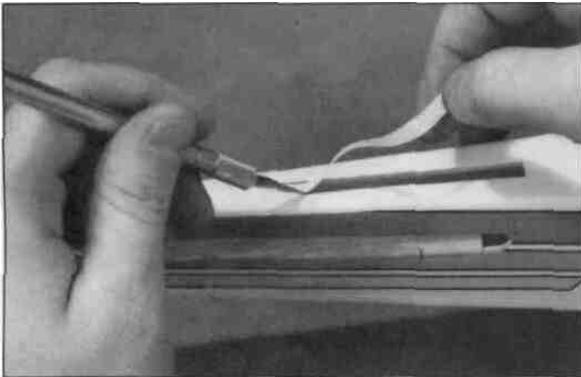

❑ 7. Using your finger, locate the **vertical fin** slot on the top of the fuselage. Remove the covering with a hobby knife.

Check the rudder and elevator hinges

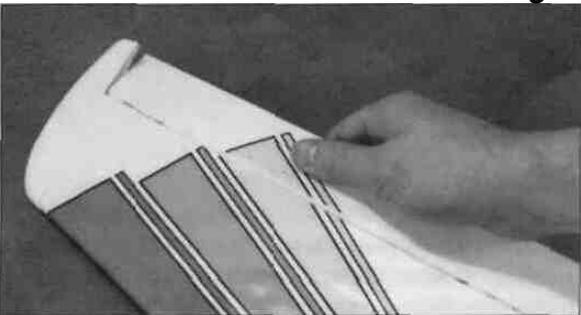

❑ 8. Gently tug on the rudder and elevator at each hinge location. If any of the hinges are loose, reglue

them as described here: First, flex the surface all the way one direction (**DO NOT REMOVE THE SURFACE**). Apply 5 drops of thin CA onto each hinge. Use a paper towel to absorb the excess glue. Wait a few minutes for the glue to harden, then flex the surface the other direction and glue the other side of the hinges. Finally, flex the surface back and forth several times to free it up.

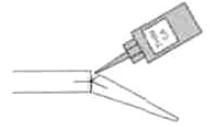

Mark the centerline

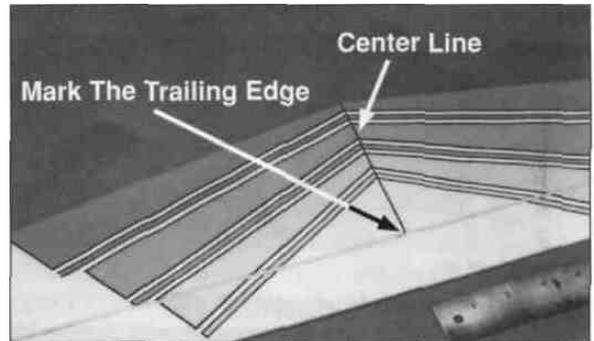

❑ 9. On the top surface of the **horizontal stabilizer**, measure to find the exact center from side to side. Draw a "center line" using a felt-tip pen. Next, extend that line onto the trailing edge, in the hinge gap, as shown. (**DO NOT MARK ON THE ELEVATOR.**)

Align the stabilizer with the wing

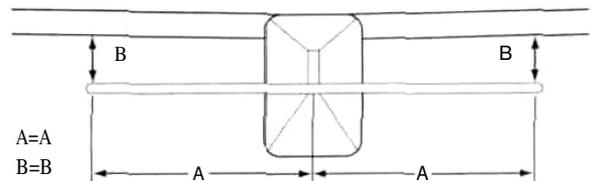

❑ 10. Insert the stabilizer into the horizontal stabilizer slot so it is centered in the fuselage (A). Place the wing onto the fuselage and view the plane from the rear. The stabilizer should be parallel with the wing (B). If not, sand the stabilizer mounting plate a little at a time until correct.

Align the stabilizer with the fuse

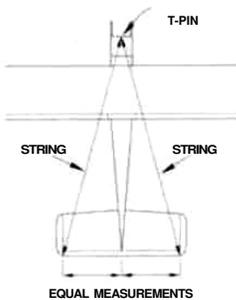

11. Attach a piece of string with a T-pin to the center of the fuselage as shown. Hold the string to the corner of the horizontal stabilizer. The distance from the pin to the horizontal stabilizer must be exactly the same on both sides.

Mark the stabilizer location

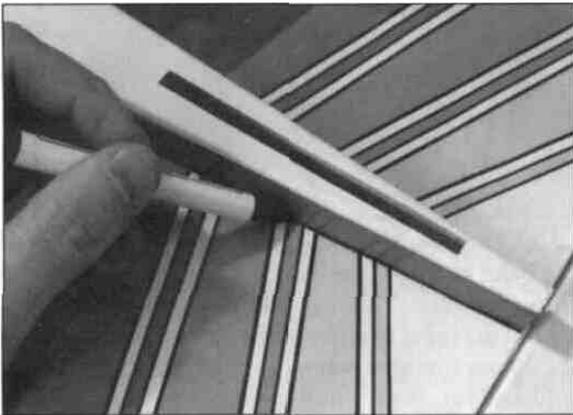

12. With the stabilizer properly aligned, using a felt tip pen, trace a line around the tail of the airplane on the top and bottom of the horizontal stabilizer.

Remove the center covering

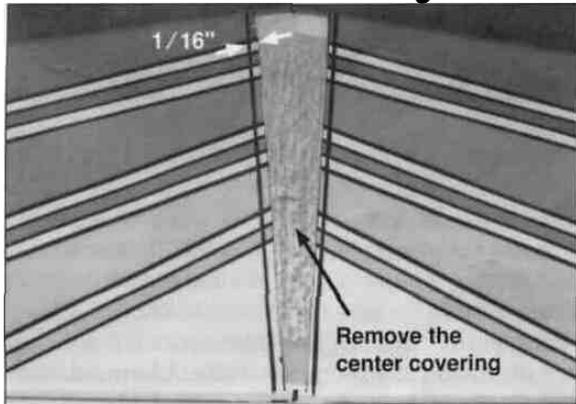

13. Remove the stabilizer and draw two additional lines, on the top and bottom, 1/16" inside the lines

drawn in the last step. Next, carefully cut through the covering using a new #11 knife blade at the inside lines and remove the covering from the center. **Do not cut the wood under the covering! This would seriously weaken the stabilizer and could easily cause the stabilizer to break in flight.** If the stab breaks the plane may crash, so be very careful when you make this cut.

Install the stabilizer

14. Mix 1/4oz. (7.5ml) of 30-minute epoxy. Using a mixing stick, place glue inside the horizontal stabilizer slot on all sides including the horizontal stabilizer mount. Insert the stabilizer from the rear, and adjust the alignment. Wipe off any epoxy that squeezes out using a paper towel dampened with rubbing alcohol. Re-check the alignment. Then, take a break until the glue cures.

Install the vertical fin



15. Trial fit the fin into the slot in the top of the fuselage. Sand the edges if necessary for a snug fit. Mix 1/4oz. (7.5ml) of 30-minute epoxy. Using a mixing stick, apply epoxy to the top of the horizontal stabilizer through the slot. Apply epoxy to the sides and bottom surfaces of the fin base that have balsa wood exposed. Insert the Fin into the slot, making sure the fin base is seated firmly on the horizontal stabilizer. Check for a perpendicular angle between the fin and the stabilizer when viewing from the rear. Check this alignment several times as the epoxy cures.

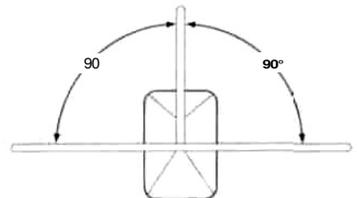

Apply the decal to the dorsal fin

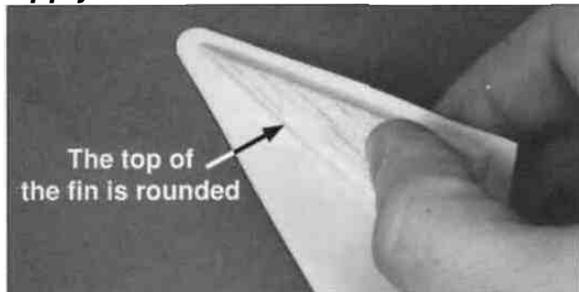

❑ 16. Attach the white decal to the balsa dorsal fin by wrapping it around the top. Trim off the excess decal material even with the edges. Do not apply to the flat bottom or aft edges

Install the dorsal fin

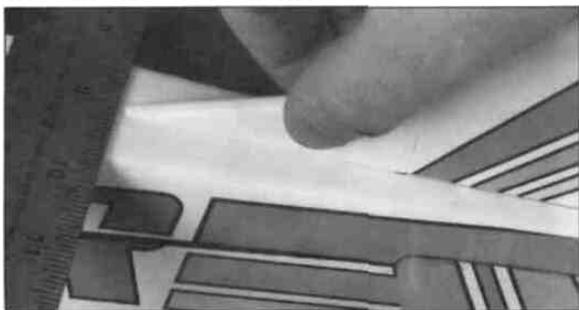

❑ 17. Hold the dorsal fin in position in front of the vertical fin. Use a ruler to measure and position the front tip of the fin in the center of the fuselage. Using a small amount of 6-minute epoxy, carefully glue the dorsal fin onto the fuselage and to the vertical fin, making sure it is centered properly.

Locations of the control horns

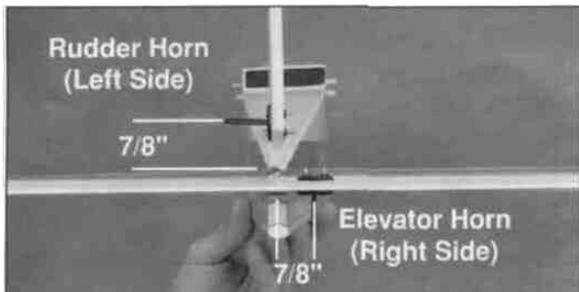

❑ 18. Notice the locations and alignment of the control horns in this photo marking and drilling. The rudder control horn must be on the left side. The elevator horn must be underneath and on the right side. The control horns should be positioned so the holes are lined up with the hinge line. (See sketch)

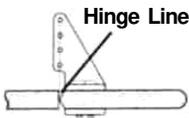

Attaching the rudder control horn

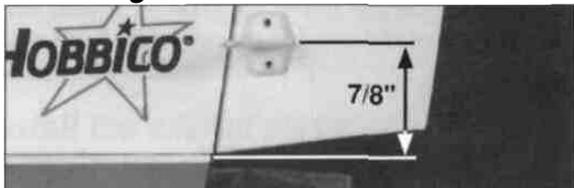

❑ 19. Position a control horn as shown in the previous sketch, 7/8" (22 mm) from the bottom of the rudder. Mark the two holes with a felt tip pen. Angle the horn slightly so it is straight with the fuselage.

Attach the control horn



❑ 20. Drill two 3/32" (2.4 mm) holes straight through the balsa rudder at the marks. Place a drop of thin CA into each hole. This will add strength to the balsa. Redrill the holes to remove any excess glue. Insert two 2 x 20mm machine screws through the control horn, and rudder, then finally screwing them into the control horn back plate on the opposite side of the rudder. Tighten the screws but do not crush the balsa. Cut off the excess threads that stick out using a wire cutter.

Install the elevator horn

❑ 21. Attach the elevator control horn in the same manner as the rudder. Place the control horn on the bottom of the elevator 7/8" (22mm) away from the fuselage (see previous photo at step 18). Mark the two holes with a felt tip pen. Drill two 3/32" (1.6mm) holes straight through the balsa elevator at the marks. Place a drop of thin CA into each hole. Redrill the holes to remove any excess glue. Thread two 2 x 20mm machine screws through the control horn, elevator and finally into the control horn back plate on the opposite side. Tighten the screws but do not crush the balsa. Cut off the excess threads.

Cut the rudder pushrod exit

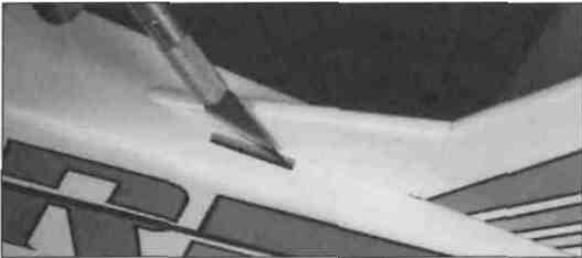

- ❑ 22. The pre-cut rudder pushrod exit hole is located on top of the fuselage on the same side as the rudder control horn. Using a hobby knife, remove the covering from the rudder pushrod exit hole.

Cut the elevator exit

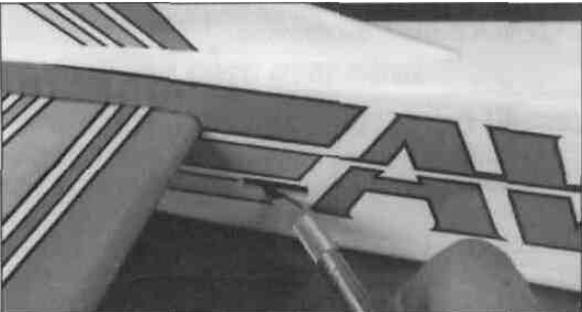

- ❑ 23. The pre-cut elevator pushrod exit hole is located on the same side of the fuselage as the elevator control horn. Locate the exit hole by gently running your finger along the side of the fuselage over the covering. It should be located approximately 1/2" in front of the stabilizer where shown. Using a hobby knife, remove the covering from the elevator pushrod exit hole.

Locate the landing gear channel

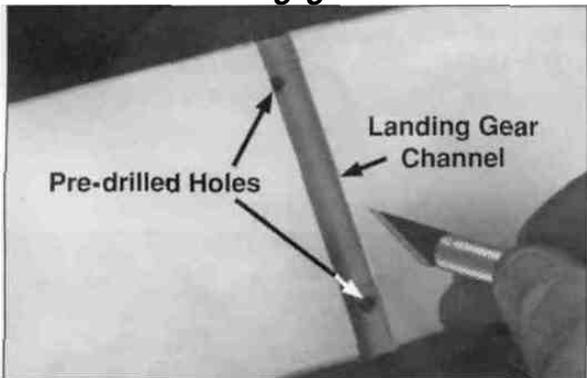

- ❑ 24. On the bottom of the fuselage, there is a channel for the main landing gear. Locate this channel by running your finger over the covering on the bottom of the fuselage. Using a hobby knife, remove the covering from this channel.

Prepare the channel for the gear

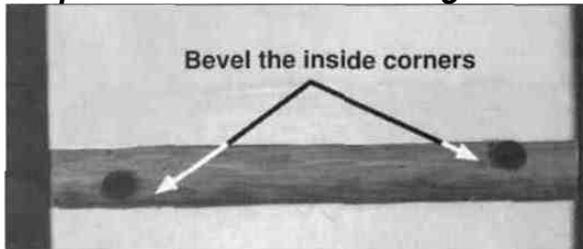

- ❑ 25. Trial fit the chrome wire landing gear struts into the holes. If they will not go in easily, drill out the two holes using an 11/64" drill bit. Next, use the drill bit or hobby knife to bevel the inside corners of the holes so that the bend in the wire will seat fully into the holes.

Install the landing gear struts

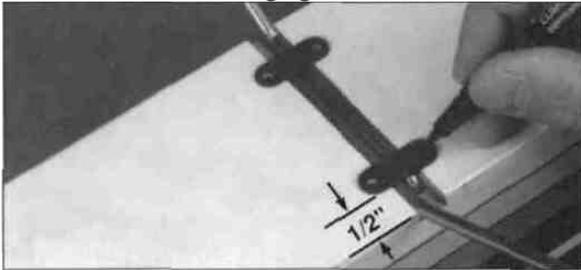

- ❑ 26. Position the two wire struts in the holes inside the channel. Center the two landing gear straps over the struts so they are approximately 1/2" from the sides of the fuselage. Mark the holes using a felt tip pen.

Drill the fuselage

- ❑ 27. Drill four holes using a 1/16" (1.6 mm) drill bit.

Mount the struts

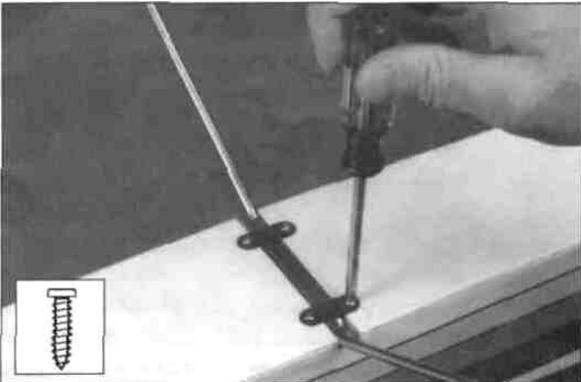

- ❑ 28. Using four 2.5 x 10mm self-tapping screws, fasten the landing gear straps to the bottom of the fuselage over the struts.

Engine Selection

The following steps 29 through 36 show the installation of components if a 2-stroke engine is used. If you are planning to install a 4-stroke engine, you will need to install the throttle and steering pushrods on the opposite side than what is shown in the photos. Pay extra attention to any special notes covering 4-stroke installation in the text.

Install the throttle guide tube



❑ 29. Cut a small notch that is 1/8" wide and 1/8" deep into the front fuselage former approximately 3/4" down from the top of the fuel tank opening. This will give the throttle pushrod a straighter line to the servo. Cut the two white plastic pushrod guide tubes so they are both 11" long.

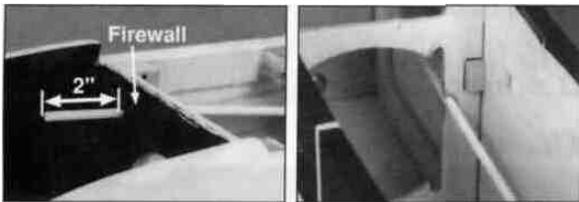

❑ 30. Using sandpaper, roughen the outside of both plastic guide tubes and clean with a paper towel dampened with rubbing alcohol. This will help the glue stick to the tubes. Install one of the tubes into the upper hole in the firewall. Position the tube so that approximately 2" protrudes out of the firewall. Mix 1/8oz. of 6-minute epoxy and glue the guide tube into the hole in the firewall and into the notch inside the fuselage as shown. **Note:** If you are installing a 4-stroke, you will need a new 1/8" hole for the throttle pushrod. Drill this hole so it lines up behind the carburetor arm on your engine. The predrilled hole is not needed and should be plugged with 6-minute epoxy.

Drill the steering pushrod exit hole

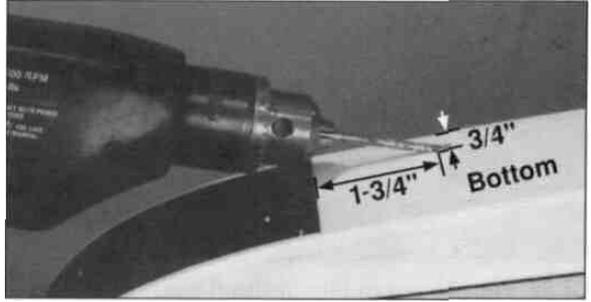

❑ 31. Measure and mark the steering pushrod exit onto the **bottom** of the fuselage 1-3/4" back from the fuselage and 3/4" in from the left side as shown. Using a 1/8" drill bit, drill a hole that angles in towards the back of the fuselage as shown. Be careful not to let the drill chuck damage the covering.

Install the steering guide tube

❑ 32. Slide the remaining guide tube into the hole you just drilled so that 2-1/2" protrudes. Mix 1/8oz. of 6-minute epoxy. Glue the tube into the hole and into the lower left slot inside the fuselage. Once the epoxy has cured, trim off this tube so it is flush with the bottom of the fuselage (see photo at step 36).

Make "Z" bends in the wire



❑ 33. Make a Z-bend at one end of both of the 1/16" x 18" wire pushrods using needle nose pliers. **NOTE:** Hobbico offers pliers that easily make perfect Z-bends (HCAR2000). See your hobby dealer.

Trim the steering arm

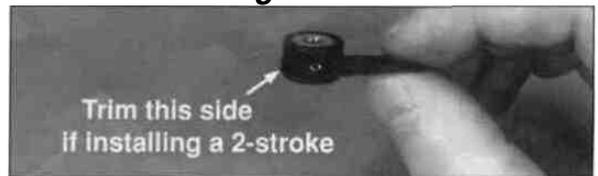

❑ 34. Locate the black plastic steering arm. I hold the arm in your hand so that the screw hole is facing you. Using a wire cutter, remove the left side of the arm (right side if installing a four stroke). It is not needed.

Install the steering pushrod

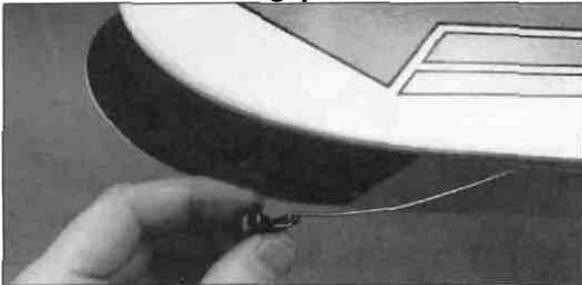

❑ 35. Attach the "Z" bend of one of the wires into the outside hole of the black plastic steering arm. Slide the wire into the plastic guide tube so that the screw hole on the steering arm is facing forward. Slightly bend the wire as needed so the arm can be positioned close to the nose gear mount (see photo at step 36).

Install the nose gear strut

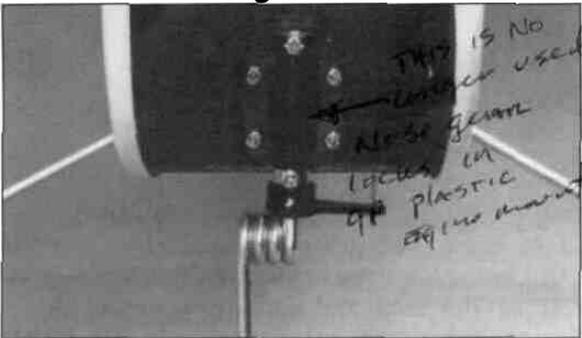

❑ 36. Install the nose gear strut through the steering arm, followed by a 4mm collar. Next, slide the strut through the nose gear mount and install a second 4mm collar onto the strut. Tighten the wheel collars to the strut using two 3 x 5mm machine screws.

Position the steering arm

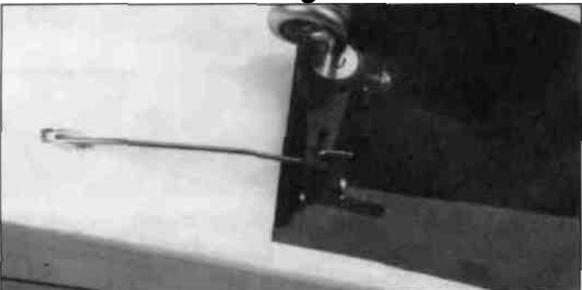

❑ 37. Rotate the nose gear strut so that the wheel (once installed) will point straight ahead. Tighten the arm to the strut using a 3 x 8mm screw. The screw will leave a mark on the strut. Remove the strut and file a small flat at this mark. This will keep the steering arm from slipping on the strut.

Assemble the fuel tank plug

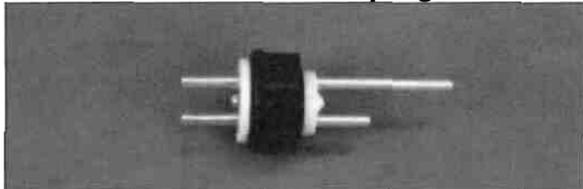

❑ 38. Push one long and one short aluminum tube through the black rubber stopper - the third aluminum tube will not be used. Place the two white plastic disks over the tubes. The larger disk should go towards the outside. The nub on the small disk should face away from the rubber stopper. Insert the 3 x 18mm self tapping screw through the larger disk, rubber plug and then into the smaller disk. Do not tighten the screw at this time.

Bend the vent tube

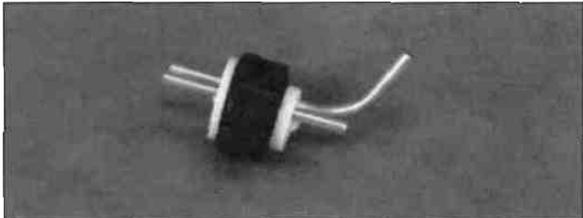

❑ 39. Bend the longer tube up as shown so that it will come within 1/16" from touching the top of the tank when installed. Use your fingers to bend the tube, being careful not to kink it closed.

Install the clunk

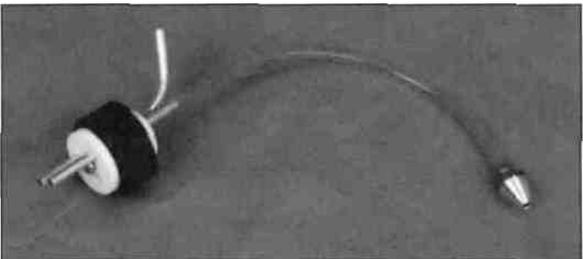

❑ 40. Locate the metal fuel pick-up weight (often referred to as the "clunk") and the fuel tubing. Cut the fuel tubing so it is only 5-1/2" long. Attach the fuel tubing to the short aluminum tube and to the clunk.

Install the stopper

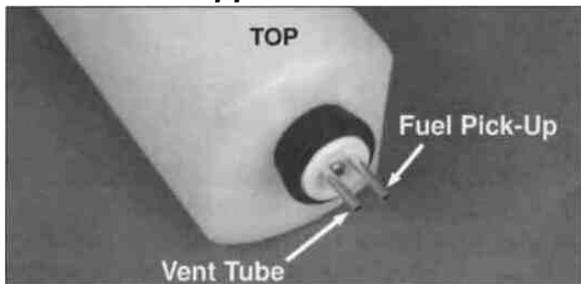

41. The stopper assembly can now be inserted into the tank. The pressure tube should be adjusted so the tube is pointed straight up just under the top of the tank. The rubber stopper must seat over the lip of the tank. Make sure that the tubes are positioned side-to-side. Tighten the stopper by turning the screw. Do not over-tighten or you may strip out the plastic disk.

Install the foam collar and bend the tubes

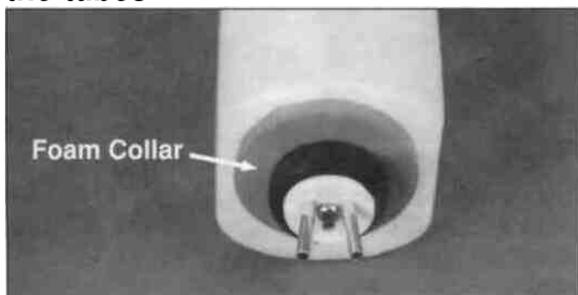

42. Locate the foam collar. Remove the inner foam circle and place the collar around the neck of the fuel tank. Bend the aluminum tubes outward slightly.

Install the tank

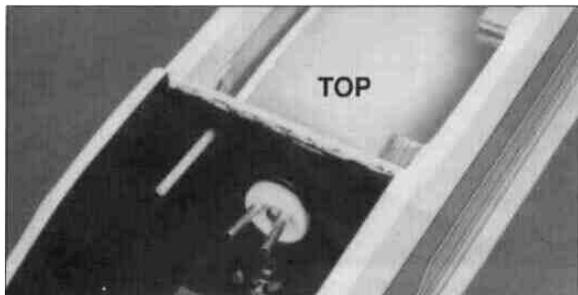

43. With the vent tube (inside the tank) pointing up, insert the fuel tank into the fuselage. Make sure the foam collar is seated well against the firewall.

Drill the hatch

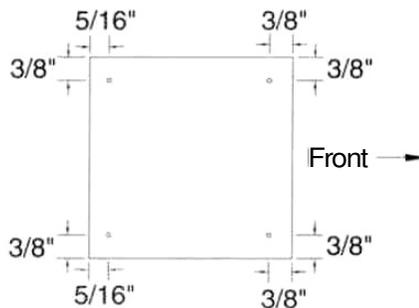

44. Drill four 1/16" holes into the tank hatch as shown in the sketch.

Install the hatch

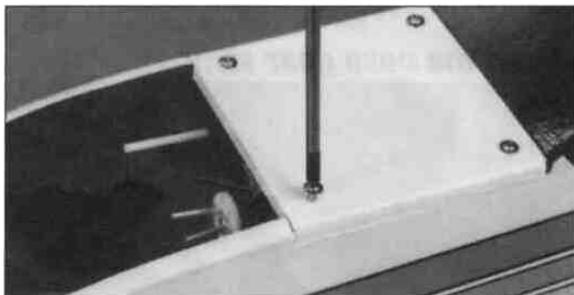

45. Place the hatch onto the fuselage and drill 1/16" holes, using the holes in the hatch as a guide, through the hatch and into the mounting blocks. Fasten the hatch using the four 2 x 12mm flanged sheet metal screws.

Align the engine with the fuselage



46. Position the engine on the mount so that the face of the engine thrust washer is 1/4" forward of the fuselage sides. Align the engine so the crankshaft is pointing straight forward. Mark the rails at the four mounting holes using a 5/32" drill bit (or a bit that fits your engine mounting holes the best) to scribe a mark. **Note:** You may need to trim the mounting rails slightly to fit your engine—this can be done with a flat file.

Drill mounting holes

❑ 47. Remove the engine from the mount and drill four 1/8" holes at the marks you just made.

Attach fuel tubing to the tank

LI 48. Cut two 6" pieces of medium silicone fuel tubing (not included). Attach one piece onto each of the aluminum tubes coming from the fuel tank.

Install the throttle pushrod

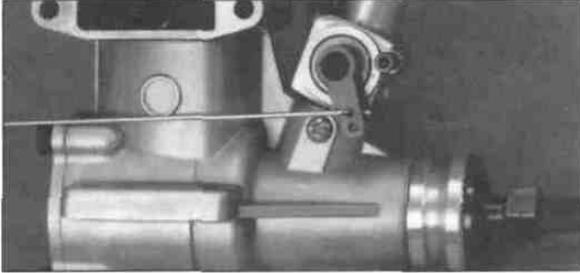

❑ 49. Attach the "Z" bend of the remaining 1/16" x 18" wire pushrod into the inside hole of the carburetor control arm.

Mount the engine

❑ 50. Slide the throttle pushrod wire into the guide tube and position the engine on the mount. Install a 3mm flat washer onto each of the four 3 x 25mm machine screws. Insert the screws through the engine lugs and mounting rails. Install a 3mm flat washer and a 3 mm lock washer onto each screw along with a 3mm hex nut. Tighten the hardware to secure the engine. Finally, apply a drop of medium CA onto the threads and nuts to prevent them from vibrating loose.

Install the muffler



❑ 51. Install the muffler onto the engine using the screws that came with the engine. Attach the fuel tubing from the "vent" in the fuel tank to the muffler pressure tap. Attach the tubing from the fuel tank to the carburetor. NOTE: You may wish to shorten the fuel lines for a more direct routing. Make sure that the lines do not get any kinks which could restrict fuel flow.

Attach the propeller to the engine

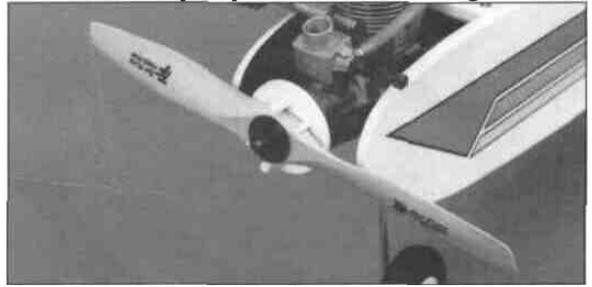

❑ 52. Ream or drill the spinner backplate to fit on the engine. Install the spinner backplate, prop, prop washer and the prop nut onto the engine. Position the prop so it is horizontal when the engine is against its compression (the point at which you feel resistance when you turn the crankshaft counterclockwise). This is a good habit to get into when installing props onto model airplanes. If the engine quits during flight, the prop will stop horizontally, therefore reducing the chance of prop breakage if you are forced to land on rough terrain. Use an adjustable wrench (not a pliers) to securely tighten the prop nut.

Install the spinner

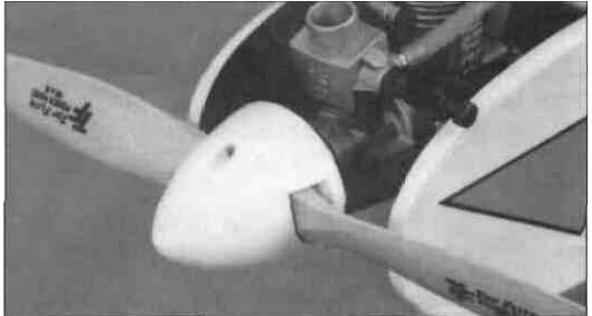

❑ 53. Trim the spinner cone slots if necessary so there is at least a 1/16" gap between the cone and the prop. Once satisfied with the fit, attach the cone with the screws provided. Be careful not to over-tighten these screws. They are threaded into plastic which can strip out easily if they are over-tightened.

Prepare the servos

❑ 54. Install the rubber grommets and bushings included with your radio system, onto the four servos. Refer to your radio manual for proper installation of these items.

Install the servo tray support



□ 55. Position the servo tray support into the fuselage directly in front of the the landing gear block. Glue in place with thick CA.

Install the servo tray

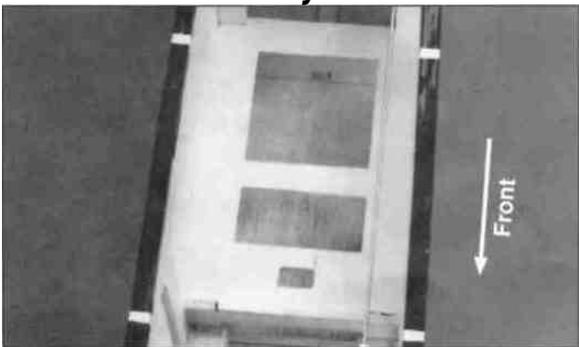

□ 56. Position the servo tray into the fuselage so that the small rectangular hole is facing forward. You may need to sand the edges and corners slightly for a good fit. Glue in place using thick CA.

Install the servos in the fuselage

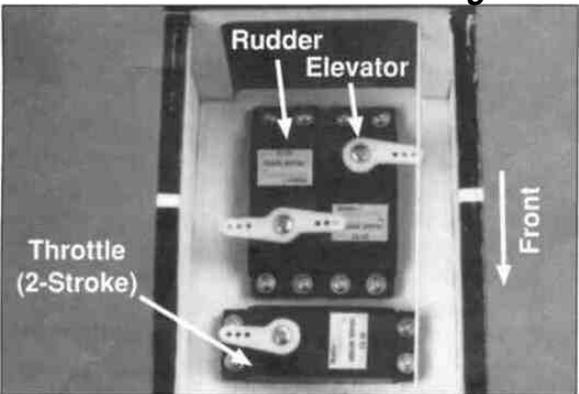

□ 57. Routing the servo wires forward, install the servos into the tray as shown using the screws included with the radio system. Enlarge the openings if needed.

Note: When installing a 4-stroke engine, the throttle servo should be installed in the opposite direction. Choose and trim the servo arms so they look similar to the ones shown in the photo.

Install the aileron servo

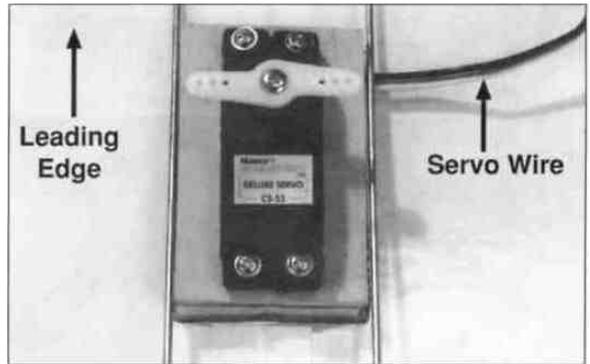

□ 58. Install the remaining servo into the servo mount in the wing. Route the wires between the tray and the bottom of the wing as shown.

Receiver and battery installation

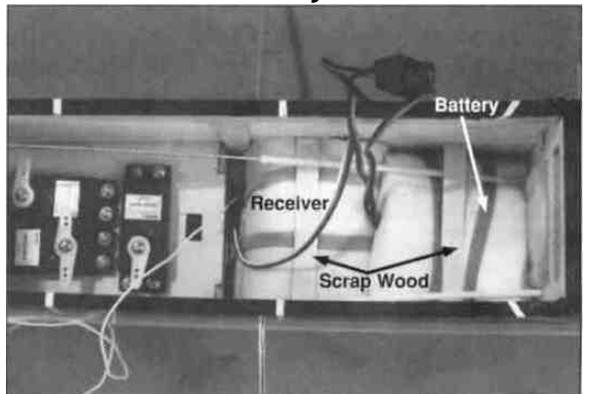

□ 59. Following the radio system's instruction manual, plug the three servos into the receiver. Next, plug a servo extension into the aileron channel of the receiver. Finally, plug the switch into the receiver. Wrap the receiver and battery pack in foam rubber (HCAQ1U50) using rubber bands or masking tape to hold the foam in place. Install the battery and receiver into (he fuselage. The battery should he located directly behind the fuel tank. The receiver should then be placed directly behind the battery. Secure these components in place using pieces of scrap wood (popsicle sticks work well) glued to the fuselage sides.

Mount the switch to the fuselage



- ❑ 60. Cut out the opening on the left side of the fuselage for the switch and install using the screws included with the switch. We recommend using a GreatPlanes Switch/Chargejack (GPMM1000, shown above.) This makes it easy and convenient for charging your receiver batteries. It is good practice to always install the switch on the side opposite the engine's exhaust.

Prepare the pushrods

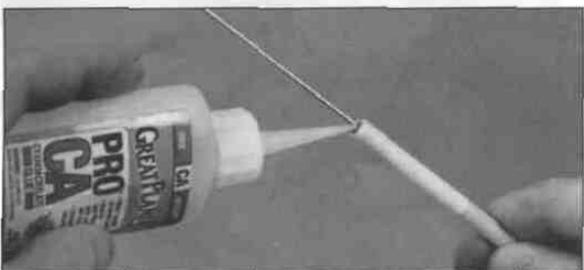

- ❑ 61. Locate the two wooden dowel pushrods and apply thin CA to the ends of the shrink tubing on both rods.

Install the pushrods

- ❑ 62. Insert the two pushrods, threaded end first, through the fuselage and out the two pushrod exits at the hack of the fuselage. You may have to bend the rods slightly to eliminate binding, but keep any bends to a minimum.

Make the clevis retainers

- ❑ 63. Cut two 1/4" wide pieces of the clear tube. Slide one on each of the pushrods that protrude out of the fuselage.

Install the two clevises

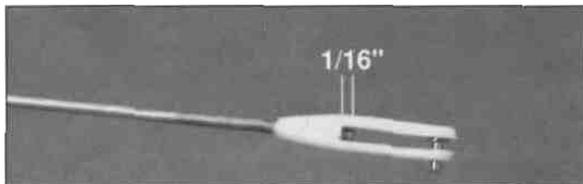

- ❑ 64. Screw a clevis onto each pushrod until the threads protrude about 1/16" between the clevis forks.

Attach the pushrods

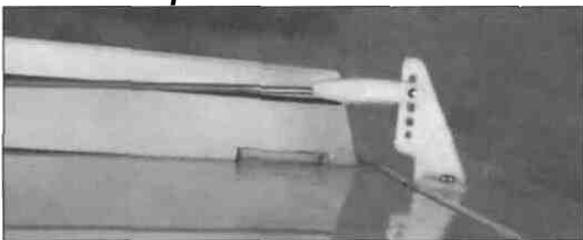

- ❑ 65. Attach the two clevises to the control horns. Use the 2nd hole from the outside for the elevator and 3rd from the outside for the rudder. Check to make certain that the pushrods do not bind in the openings and that they operate smoothly. Slide the clevis retainers over the clevis forks.

Center the servos with your radio

- ❑ 66. Turn the transmitter on and then the receiver switch. Center all of the trim levers and place the throttle stick at its midway position. Turn off the receiver switch and then the transmitter. By doing this, your servos will be at their centered (neutral) position when you connect the pushrods. Refer to the following photos and replace or trim the servo arms as shown. To do this, simply remove the servo arms and reposition them on the splined servo output shaft. Be sure to reinstall the screws.

Mark the pushrods

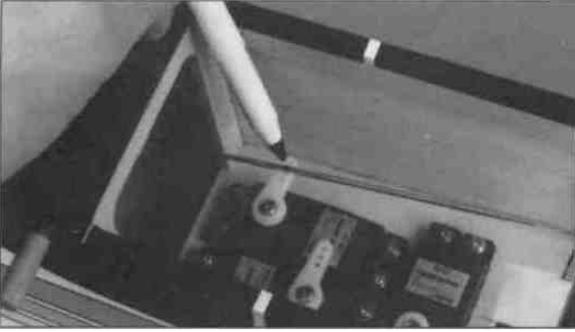

❑ 67. Holding the elevator in its neutral position, mark the pushrod wire where it crosses the servo arm as shown (using a felt-tip pen). Next, hold the rudder at its neutral position and mark the wire the same way (see photo at step 71).

Cut the pushrods

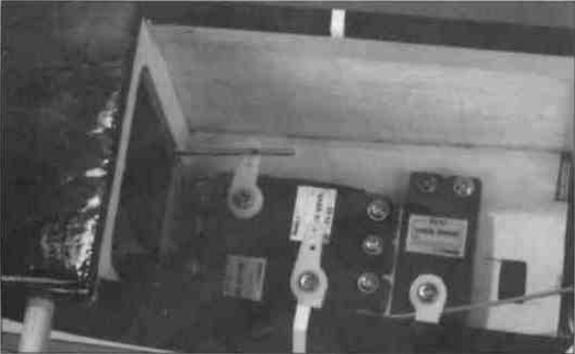

❑ 68. Cut off the pushrods approximately 3/8" past the marks. Removing the pushrods will make this and the next step easier.

Connect the pushrods



❑ 69. Make a "Z" bend at each mark. Remove the servo arms from the servos. Attach the rods to the servo arms. You may need to enlarge the holes slightly on the arms. A 5/64" drill bit works great for this. Reattach the servo arms in the same position.

Attach the pushrod connector



❑ 70. Install a pushrod connector on the opposite side of the rudder pushrod. This will be for the steering pushrod. Thread the nut onto the connector. The connector must be able to rotate in the servo arm, so do not over-tighten the nut. Place a small drop of thin CA onto the threads to lock the nut in place. Thread a 3 x 4mm machine screw into the connector. Reattach the servo arms in the same position. Be sure to reinstall the servo screws.

Install the steering pushrod

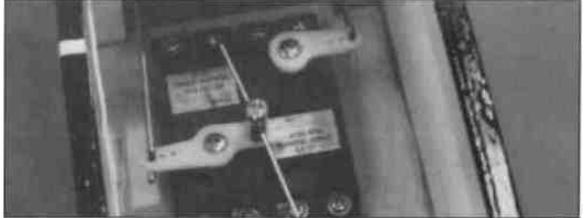

❑ 71. Slide the wire steering pushrod into the pushrod connector. Straighten the nose gear and tighten the pushrod connector screw. Using a wire cutter, carefully remove the excess wire, leaving only about 3/4" remaining past the connector.

Connect the throttle servo

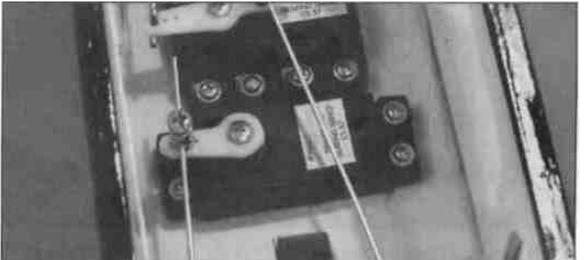

❑ 72. Install the second pushrod connector onto the throttle servo arm but do not apply CA glue to the threads yet. You may have to move this connector later. Slide the throttle pushrod wire through the connector. Hand tighten this screw so that the carburetor is half open. Final throttle adjustment will be made later. Using a wire cutter, carefully remove the excess wire, leaving only about 3/4" remaining past the connector.

Mount the switch to the fuselage

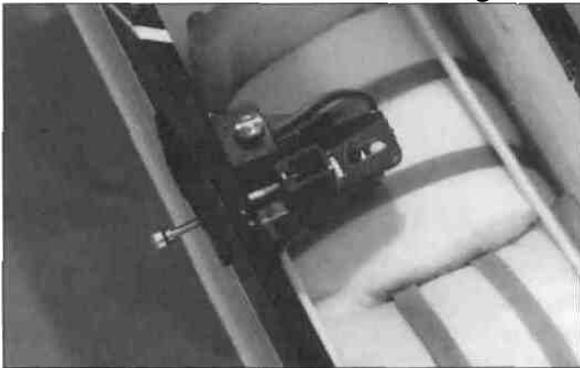

❑ 60. Cut out the opening on the left side of the fuselage for the switch and install using the screws included with the switch. We recommend using a GreatPlanes Switch/Chargelack (GPMM1000, shown above.) This makes it easy and convenient for charging your receiver batteries. It is good practice to always install the switch on the side opposite the engine's exhaust.

Prepare the pushrods

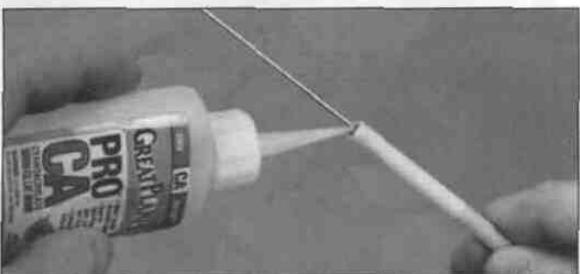

❑ 61. Locate the two wooden dowel pushrods and apply thin CA to the ends of the shrink tubing on both rods.

Install the pushrods

❑ 62. Insert the two pushrods, threaded end first, through the fuselage and out the two pushrod exits at the back of the fuselage. You may have to bend the rods slightly to eliminate binding, but keep any bends to a minimum.

Make the clevis retainers

❑ 63. Cut two 1/4" wide pieces of the clear tube. Slide one on each of the pushrods that protrude out of the fuselage.

Install the two clevises

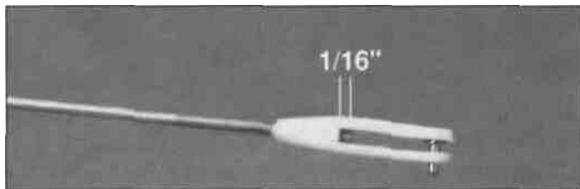

❑ 64. Screw a clevis onto each pushrod until the threads protrude about 1/16" between the clevis forks.

Attach the pushrods

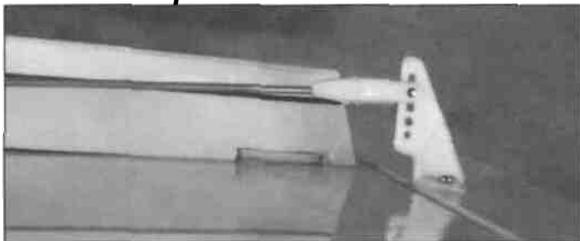

❑ 65. Attach the two clevises to the control horns. Use the 2nd hole from the outside for the elevator and 3rd from the outside for the rudder. Check to make certain that the pushrods do not bind in the openings and that they operate smoothly. Slide the clevis retainers over the clevis forks.

Center the servos with your radio

❑ 66. Turn the transmitter on and then the receiver switch. Center all of the trim levers and place the throttle stick at its midway position. Turn off the receiver switch and then the transmitter. By doing this, your servos will be at their centered (neutral) position when you connect the pushrods. Refer to the following photos and replace or trim the servo arms as shown. To do this, simply remove the servo arms and reposition them on the splined servo output shaft. Be sure to reinstall the screws.

Mark the pushrods

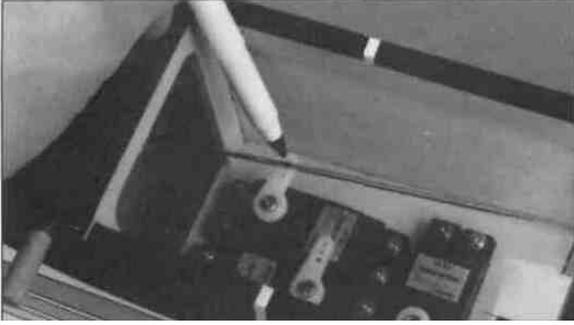

❑ 67. Holding the elevator in its neutral position, mark the pushrod wire where it crosses the servo arm as shown (using a felt-tip pen). Next, hold the rudder at its neutral position and mark the wire the same way (see photo at step 71).

Cut the pushrods

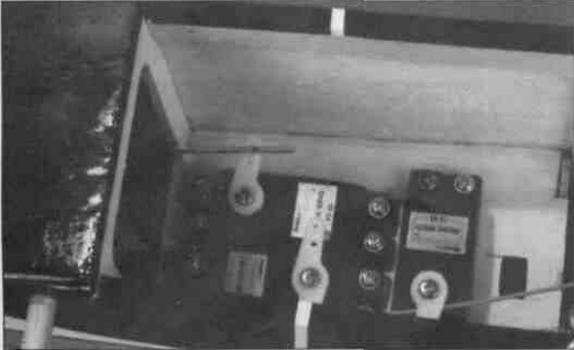

❑ 68. Cut off the pushrods approximately 3/8" past the marks. Removing the pushrods will make this and the next step easier.

Connect the pushrods



❑ 69. Make a "Z" bend at each mark. Remove the servo arms from the servos. Attach the rods to the servo arms. You may need to enlarge the holes slightly on the arms. A 5/64" drill bit works great for this. Reattach the servo arms in the same position.

Attach the pushrod connector



❑ 70. Install a pushrod connector on the opposite side of the rudder pushrod. This will be for the steering pushrod. Thread the nut onto the connector. The connector must be able to rotate in the servo arm, so do not over-tighten the nut. Place a **small** drop of thin CA onto the threads to lock the nut in place. Thread a 3 x 4mm machine screw into the connector. Reattach the servo arms in the same position. Be sure to reinstall the servo screws.

Install the steering pushrod



❑ 71. Slide the wire steering pushrod into the pushrod connector. Straighten the nose gear and tighten the pushrod connector screw. Using a wire cutter, carefully remove the excess wire, leaving only about 3/4" remaining past the connector.

Connect the throttle servo

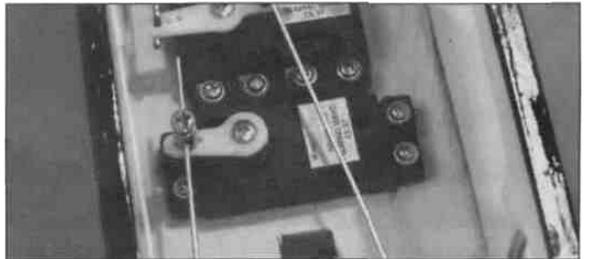

❑ 72. Install the second pushrod connector onto (the throttle servo arm but do not apply CA glue to the threads yet. You may have to move this connector later. Slide the throttle pushrod wire through the connector. Hand tighten this screw so that the carburetor is half open. Final throttle adjustment will be made later. Using a wire cutter, carefully remove the excess wire, leaving only about 3/4" remaining past the connector.

Connect the aileron servo

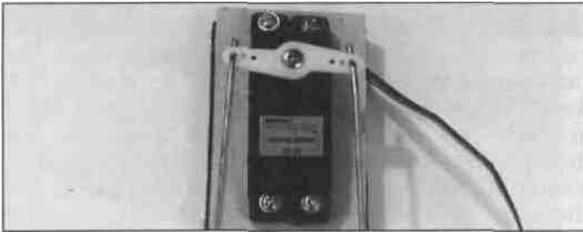

73. Hold the ailerons at neutral and mark the servo wheel where the rods intersect the holes in the servo arm. Make a "Z" bend at the marks and attach to the servo arms.

Straighten the antenna

74. Unwind the antenna and straighten (do not stretch) the wire to its full length. Do not cut the antenna wire as this will decrease the range and sensitivity of your receiver.

Drill an antenna exit

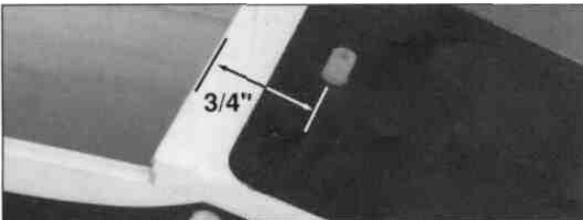

75. Using a 3/16" drill bit, drill a hole centered approximately 3/4" behind the wing saddle on top of the fuselage. Cut a 1/2" long piece of medium fuel tubing and center it inside this hole.

Securing the antenna

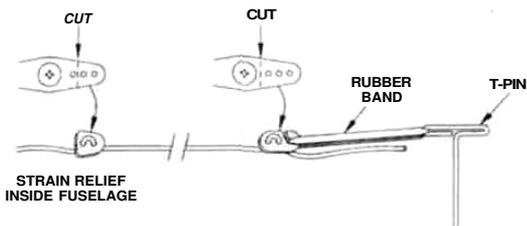

76. Route the antenna away from the servos, make a strain relief from a spare servo arm and route the antenna through. Next, route the antenna up through the antenna exit. Use a trimmed servo arm and rubber band at the end of the antenna and attach to a T-pin. Push the pin into the top of the fin. Adjust the trimmed servo arm until there is a slight amount of tension on the antenna wire. The rubber band should be partially stretched.

Install the wheels

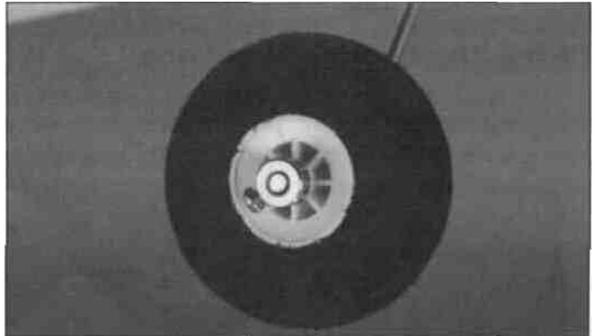

77. Place one wheel collar on each strut, followed by a wheel. Secure each wheel with an additional wheel collar. The wheels must all spin freely and have no tendency to bind.

Attach the Wing

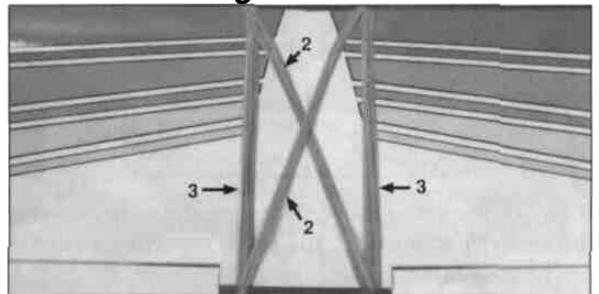

78. Connect the aileron servo to the aileron extension and attach the wing onto the fuselage using 10 #64 rubber bands. Install 3 on each side first from front to back. Then criss-cross the remaining 4. This will hold the wing securely, but will allow it to pop off in the event of a cartwheel on the ground, thus minimizing damage.

Check The Control Directions

1. Turn on the Transmitter and then the Receiver. Standing behind the plane, make the following movements with the transmitter and observe the control surfaces:

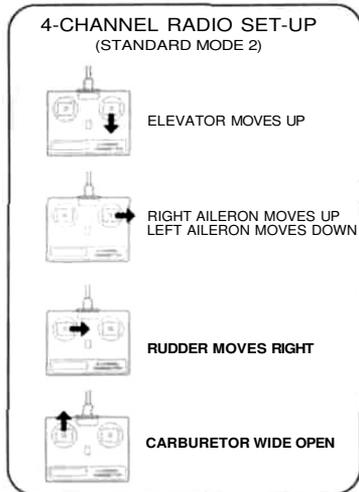

If any of the servo movements are opposite, reverse the servo direction with the servo reversing switches on the transmitter.

Adjust The Throttle

2. For added safety and convenience, the throttle should be set up so that the engine can be stopped using the throttle trim. To do this, loosen the pushrod connector screw and move the throttle pushrod so that the carburetor is completely closed with the throttle stick and trim lever on the transmitter fully back. (NOTE: If the carburetor does not fully close, adjust the idle stop screw on the carburetor until it will.) Next, tighten the screw on the pushrod connector. Test the trim lever by advancing it to full. This will be a fast idle position with the carburetor barrel slightly open (about 1/32"). See sketch. Now move the throttle stick forward to full. Make sure that the carburetor barrel opens all the way. See sketch. If it doesn't open far enough or opens too far (bending the rod) move the pushrod connector in or out on the servo arm and/or the carburetor arm to gain or reduce movement. Apply a small amount of thin CA onto the threads of the pushrod

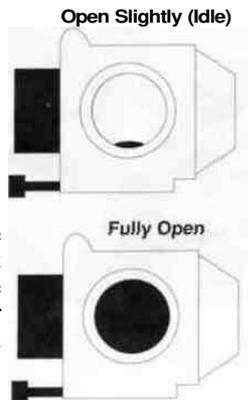

connector. The throw will be correct when the carburetor barrel will stop fully open at the same time the throttle stick reaches full. With the throttle set up properly, you should be able to run the engine with the trim lever set midway to full position (adjusted for a smooth but slow idle). Then when it is time to stop the engine, simply pull back the trim to close the carburetor and the engine will stop running.

Adjust the control throws:

3. Check the movement of the control surfaces. Use a ruler to match our measurements listed below. If your radio features dual rates, set up both the high and the low rates following the radio system's instructions. If your radio does not have dual rates, set up the plane using the low rates first and increase the throws as you get familiar with the plane.

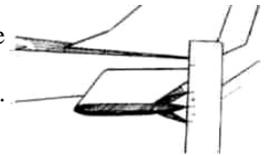

	Low rate	High rate
Aileron:	3/16" up 3/16" down	5/16" up 5/16" down
Elevator:	1/4" up 1/4" down	3/8" up 1/4" down
Rudder:	5/8" left 5/8" right	3/4" left 3/4" right

These are the suggested deflections from center.

If you need more movement, you should move the clevis to a hole closer to the surface or you can install a larger servo wheel and move the rod further out from center. If you have too much movement, do the opposite. See sketches below:

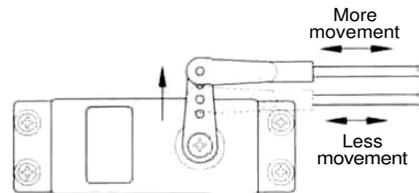

Moving the clevis outward on the servo arm results in more pushrod movement.

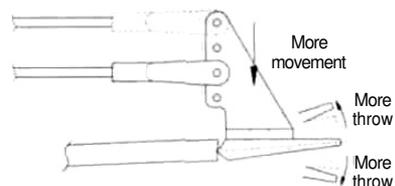

Moving the clevis inward on the control horn results in more throw.

PREPARING TO FLY YOUR AVISTAR II

If you're a novice, there is one thing that you will need to fly your Avistar II safely that is not furnished with the kit: You will need a qualified instructor to teach you to fly. No model ever made will let you teach yourself to fly safely. It can be done, but you would be seriously risking more than just the airplane. To find an instructor, you should join an R/C flying club. If there is not a club nearby, then you should find an experienced model pilot who is willing to help you. The chosen instructor should fly well enough to allow you to concentrate on your own flying. If you are worried about your instructor crashing your model, you will not be able to concentrate on learning to fly. After you have found an instructor, you should spend some time just talking with him about what you will be trying to learn. He should inspect the model to be certain that it is ready to fly. Listen to him and try to gain from his experience.

Now that you have a good model and an instructor whom you trust, you can go out and get started learning to fly. You can expect to be very nervous at first, and will make some mistakes. There will be several instances where the instructor will prevent you from crashing. This will be unsettling, but the thing to do is jump right back into flying the model (after your knees stop shaking, of course). This is one of the most important things about learning to fly model airplanes...you have to fly! Fly as often as you can. Be sure to make several flights each time you go to the flying field, but give yourself time after each flight to calm down and discuss the flight with your instructor. Spending some time after each flight talking about what happened and what you need to work on to improve your skills will pay off with greater confidence in your own growing abilities.

CHARGE THE BATTERIES

Follow the battery charging procedures in your radio instruction manual. You should always charge your transmitter and receiver batteries the night before you go flying, and at other times as recommended by the radio manufacturer.

BALANCE THE PROPELLER

Balance your propellers carefully before flying. An unbalanced prop is the single most significant cause of damaging vibration. Not only will engine mounting screws and bolts vibrate out, possibly with disastrous effect, but vibration will also damage your radio receiver and battery. Vibration will cause your

fuel to foam, which will, in turn, cause your engine to run rough or quit.

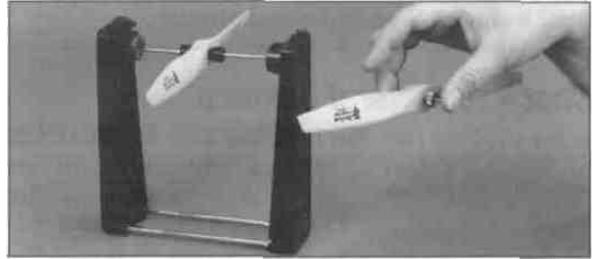

We use a Top Flite Precision Magnetic Prop Balancer (#TOPQ5700) in the workshop and keep a Great Planes Fingertip Balancer (#GPMQ5000) in our flight box.

FIND A SAFE PLACE TO FLY

1. The best place to fly your R/C model is an AMA (Academy of Model Aeronautics) chartered club field. Ask your hobby shop dealer if there is such a club in your area and join. Club fields are set up for R/C flying, which makes your outing safer and more enjoyable. The AMA can also tell you the name of a club in your area. We recommend that you join the AMA and a local club so you can have a safe place to fly and also have insurance to cover you in case of a flying accident. (The AMA address is listed at the front of this instruction book).

If there is not a flying club in your area, you need to find a large open area, free of obstructions, with a smooth surface that can be used as a runway. It should be located at least 6 miles away from any other R/C airplane operation and away from houses, buildings and streets. A schoolyard may look inviting but it is too close to people, power lines and possible radio interference.

GROUND CHECK THE MODEL

If you are not thoroughly familiar with the operation of R/C models, ask an experienced modeler to check to see that you have the radio installed correctly and that all the control surfaces do what they are supposed to. The engine operation must also be checked and the engine "broken in." Follow the engine manufacturer's recommendations for break-in. Check to make sure all screws remain tight, that the hinges are secure and that the prop is on tight.

RANGE CHECK YOUR RADIO

Check the operation of the radio every time you fly. This means that with the transmitter antenna collapsed and the receiver and transmitter on, you should be able to walk at least 100 feet away from the model and still have control. Have someone help you. Have them stand by your model and, while you work the controls, tell you what the various control surfaces are doing.

Repeat this test **with the engine running** at various speeds while an assistant holds the model. If the control surfaces do not act correctly at all times, **do not fly!** Find and correct the problem first.

ENGINE SAFETY PRECAUTIONS

NOTE: Failure to follow these safety precautions may result in severe injury to yourself and others.

Keep all engine fuel in a safe place, away from high heat, sparks or flames, as fuel is very flammable. Do not smoke near the engine or fuel; remember that the engine exhaust gives off a great deal of deadly carbon monoxide. Therefore do not run the engine in a closed room or garage.

Get help from an experienced pilot when learning to operate engines.

Use safety glasses when starting or running engines.

Do not run the engine in an area of loose gravel or sand, as the propeller may throw such material in your face or eyes.

Keep your face and body as well as all spectators away from the plane of rotation of the propeller as you start and run the engine.

Keep items such as these away from the prop: loose clothing, shirt sleeves, ties, scarfs, long hair or loose objects (pencils, screw drivers) that may fall out of shirt or jacket pockets into the prop.

Use a "chicken stick" device or electric starter; follow instructions supplied with the starter or stick. Make certain that the glow plug clip or connector is secure so that it will not pop off or otherwise get into the running propeller.

Make all engine adjustments from **behind** the rotating propeller.

The engine gets hot! Do not touch it during or after operation. Make sure fuel lines are in good condition.

To stop the engine, cut off the fuel supply by pinching the fuel line. Do not use hands, fingers or any body part to try to stop the engine. Do not put anything into the prop of a running engine.

AMA SAFETY CODE

Read and abide by the Academy of Model Aeronautics Official Safety Code, a portion of which is reprinted here:

GENERAL

1. I will not fly my model aircraft in sanctioned events, air shows, or model flying demonstrations until it has been proven to be airworthy by having been previously successfully flight tested.
2. I will not fly my model aircraft higher than approximately 400 feet within 3 miles of an airport without notifying the airport operator. I will give right-of-way and avoid flying in the proximity of full-scale aircraft. Where necessary, an observer shall be utilized to supervise flying to avoid having models fly in the proximity of full-scale aircraft.
3. Where established, I will abide by the safety rules for the flying site I use, and I will not willfully and deliberately fly my models in a careless, reckless and/or dangerous manner.
6. I will not fly my model unless it is identified with my name and address or AMA number, on or in the model.
8. I will not operate models with pyrotechnics (any device that explodes, burns, or propels a projectile of any kind)...

RADIO CONTROL

1. I will have completed a successful radio equipment ground range check before the first flight of a new or repaired model.
2. I will not fly my model aircraft in the presence of spectators until I become a qualified flyer, unless assisted by an experienced helper.
3. I will perform my initial turn after takeoff away from the pit or spectator areas, and I will not thereafter fly over pit or spectator areas unless beyond my control.
4. I will operate my model using only radio control frequencies currently allowed by the Federal Communications Commission...

FLYING YOUR AVISTAR II

It is best if you let the instructor test fly the model first. Once he has flown the model he will adjust the trim to eliminate any turning, climbing, or diving tendencies that he found on the test flight. This will help make your first flights much easier and safer.

One thing to keep in mind with R/C models (whether it be cars, boats, or planes) is that the rudder and aileron controls may seem to "reverse" when the model is moving toward you. For example, if you are flying toward yourself, and you give a right control input (ailerons or rudder), the model will move off to your left. The fact of the matter is, of course, that the controls are not reversed and the aircraft did actually enter a right turn. The plane does move off to your left from your vantage point, but if you imagined yourself in the cockpit you would realize the plane turned to the right as commanded. All it takes is a little practice to maintain proper orientation of your aircraft, but that's why we recommend finding an instructor.

There is a memory aid that may help keep you out of trouble when the plane is flying toward you — "put the stick under the low wing." In other words, move the stick in the direction of the low wing to raise that wing. When you are comfortable flying the aircraft, you can practice using the rudder along with the ailerons to 'coordinate' the turns, usually, a small amount of rudder applied in the direction of the turn will keep the tail following in the exact same track as the nose.

Ground Handling: Start with learning to steer the model on the ground using the rudder and throttle. You should learn to guide the airplane on the ground at various speeds and directions. Be careful—you do not have brakes, so do not get close to any obstacles.

Take Off: Line up as straight into the wind as possible. Gradually advance the throttle to get the model rolling. Advance the throttle to full. Using rudder inputs, guide the plane straight down the runway. Let the plane get up to flying speed on the ground before lifting off. Once up to speed, lift off by smoothly applying a little up elevator and climb out gradually. Do not try to gain altitude or turn until the airplane gains additional speed. Altitude will naturally come as airspeed increases.

Flying: We recommend that you take it easy with your new model for the first several flights and gradually "get acquainted" with the airplane as your engine gets fully broken-in. As you will see, this airplane is smooth and very predictable. Your confidence will grow to the point that flying is more fun than ever. Just remember to take your time. Follow your instructor's advice and learn to control the model in the many basic maneuvers possible.

Your first flights should consist of mostly straight and level flight with gentle turns to keep the model over the field. These flights will give you practice at coordinating your control inputs and maintaining the proper orientation of the airplane. As mentioned earlier, turns are accomplished by banking the aircraft with the ailerons, then gently adding some back stick (up elevator). Enough back stick should be held in to keep the aircraft at a constant altitude—to stop turning, apply opposite aileron (or rudder) to level the wings, then release the sticks. The most common mistake when learning to fly is over-control. Think of *pressure* instead of large movements of the control sticks. Add and practice one maneuver at a time, learning how your Avistar behaves in each one. For ultra-smooth flying and normal maneuvers, we recommend using the "low rate" settings as listed on page 24. High rate control throws will give your Avistar enough control for loops, barrel rolls, and many other basic aerobatic maneuvers.

Landing: When it's time to land reduce throttle and do a couple of slow flybys (again, straight into the wind) at a safe altitude and get familiar with the plane's slow flying characteristics. Landings will involve learning to judge the height, position, direction and speed of the model in relation to the runway. You should not attempt to land the model yourself until you are comfortable flying the model in the air. Landing is the most difficult maneuver for beginners, so it should only be practiced after you can fly confidently.

As with takeoffs, always land into the wind. Adding 2 to 3 "clicks" of up elevator will help slow the model and allow easier landings. Line up with the runway and reduce the throttle to idle. Glide the model down using ailerons to keep the wings level and elevator to control altitude. Be careful not to use too much elevator at slower speeds. This could cause the airplane to stall too close to the ground. If the airplane is coming in short, gradually increase the throttle to get to the runway. If you come in too fast, raise the throttle slowly and abort the landing. Do not force the plane to land. Try again with a slightly lower approach, just before touchdown, add in a little more elevator to flare the airplane for a smooth touchdown. Perfect landings are difficult, so practice them often.

Thank you for choosing the Avistar II. We hope that it will be one of many, in a lifetime enjoyment of radio control airplanes.

Glossary of Terms

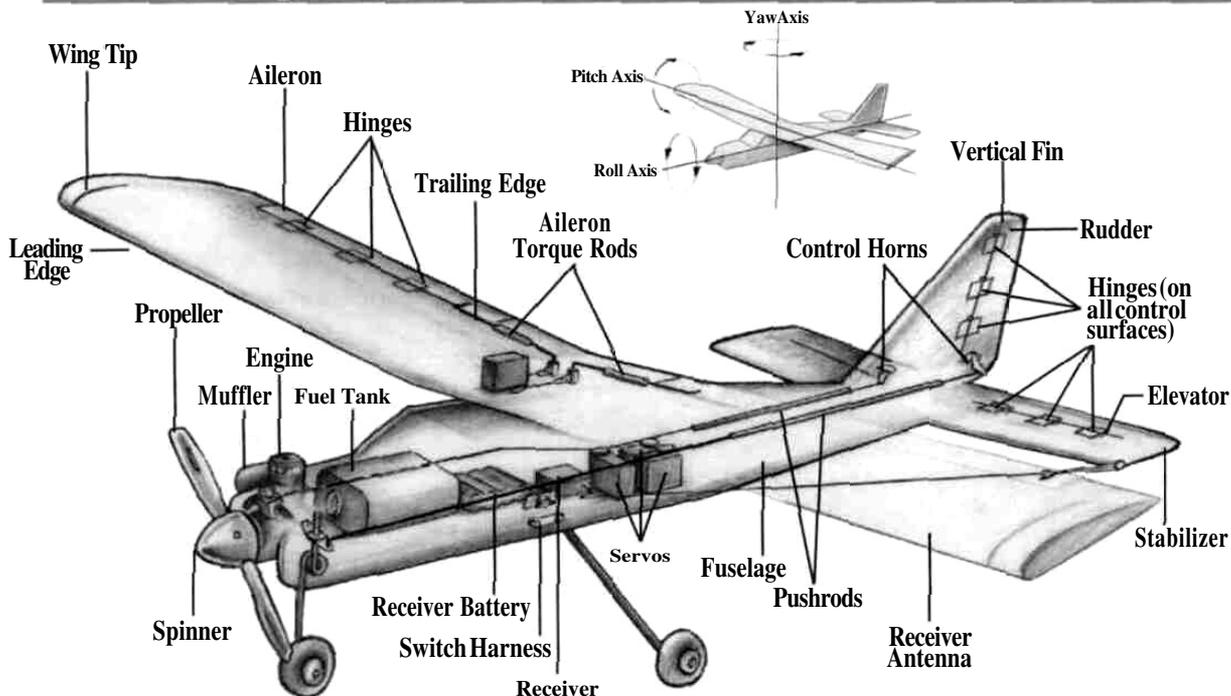

Ailerons - Hinged control surfaces located on the trailing edge of the *wing*, one on each side, which provide control of the airplane about the *roll axis*. The control direction is often confusing to first time modelers. For a right roll or turn, the right hand aileron is moved upward and the left hand aileron downward and vice versa for a left roll or turn.

Angle of attack - The angle that the wing penetrates the air. As the angle of attack increases, so does lift (and drag).

ARF - A pre-fabricated model - Almost Ready to Fly.

CA - Abbreviation for "Cyanoacrylate." An instant type glue that is available in various viscosities (Thin, Medium, Thick, and Gel). These glues are ideal for the assembly of wood airplanes and other porous materials. NOTE: Most CA glues will attack foam.

Canard - A unique type of airplane, in which the wings are located near the back of the *fuselage* and the

horizontal stabilizer is located at the nose of the fuselage.

Carburetor - The part of the engine which controls the speed or throttle setting and lean/rich mixture via setting of the *needle valve*.

CG - "Center of Gravity." The point at which the airplane balances fore to aft. This point is critical in regards to how the airplane reacts in the air. A tail-heavy plane will be very snappy but generally very unstable and susceptible to more frequent stalls. If the airplane is nose heavy, it will tend to track better and be less sensitive to control inputs, but, will generally drop its nose when the throttle is reduced to idle. This makes the plane more difficult to land since it takes more effort to hold the nose up. A nose heavy airplane will have to come in faster to land safely.

Charge Jack - The plug receptacle of the *switch harness* which the charger is plugged into to charge the airborne battery. An *expanded scale voltmeter (ESV)* can also be plugged into it to monitor battery voltage during a flying session. It is

advisable to mount the charge jack in an accessible area of the *fuselage* so an *ESV* can be used without removing the *wing*.

Charger-Device used to recharge batteries and usually supplied with the radio if *NiCd* batteries are included.

Chicken Stick - A hand held stick used to flip start a model airplane *engine*.

Clunk - A weighted fuel pick up used in a fuel tank to assure the intake line is always in fuel.

Clevis - A small clip which is threaded or soldered onto the wire end of a pushrod and connects the pushrod to the *control horn* of a control surface. The threads allow fine adjustment of length of the *pushrod*.

Computer Radio - A radio control unit in which the *transmitter* has several advanced functions which

can be programmed completely to fine tune an airplane without making mechanical changes.

Control Horn - The arm which is attached to a control surface at the hingeline and is connected to a *pushrod*.

Dead Stick- A term used to describe unpowered flight (glide) when the *engine* quits running.

Delta Wing - An airplane with a triangle shaped *wing*. Delta wings have no *horizontal stabilizer*.

Dihedral-The V shaped bend in the wing. Typically more dihedral causes more aerodynamic stability in an airplane, and causes the *rudder* to control both the *roll* and *yaw axis*. This is why some *trainers* and *sailplanes* require only 3 channels of radio control—i.e., having no *aileron*s.

Electric Starter- A hand held, electric motor used for starting a model airplane *engine*.

Elevator- Hinged control surface located at the trailing edge of the *horizontal stabilizer*, which provides control of the airplane about the *pitch axis* and causes the airplane to climb or dive. The correct direction of control is to pull the *transmitter* elevator control stick back, toward the bottom of the transmitter, to move the elevator upward, which causes the airplane to climb and vice versa to dive.

Engine - The source of thrust of an airplane.

Epoxy - A two part resin/hardener glue that is extremely strong. It is generally available in 6 and 30 minute formulas. Used for critical points in the aircraft where high strength is necessary.

Expanded Scale Voltmeter (ESV) - Device used to read the battery voltage of the on board battery pack or *transmitter* battery pack.

Flaps - Hinged control surface located at the trailing edge of the *wing* inboard of the *aileron*s. The flaps are lowered to produce more aerodynamic lift from the wing, allowing a slower takeoff and landing speed. Maneuvering flaps move up and down in conjunction with the *elevator*, and enhance the pitch control of the airplane. This is used on some acrobatic type of models, and requires a mechanical or electronic channel mixer. Note: Flaps and Maneuvering Flaps are advanced features and are not necessary or recommended on *trainer aircraft*.

Flaperon - Control Surfaces on a standard type airplane, located at the trailing edge of the *wing*, which function as *aileron*s by moving differentially, and as flaps by moving up or down together. Flaperons require either a mechanical or electronic channel mixer. Note: Flaperons are an advanced feature and are not recommended on *trainer aircraft*.

Flare - The point on your landing approach in which you give an increased amount of up elevator to smooth the touchdown of the airplane.

Flight Box - A special box used to hold and transport all equipment used at the flying field.

Flight Pack - or Airborne pack. All of the radio equipment installed in the airplane, i.e., *Receiver*, *Servos*, *Battery*, *Switch harness*.

Flutter - A phenomenon where the elevator or aileron control surface begins to oscillate violently in flight. This can sometimes cause the surface

to depart from the aircraft and cause a crash. There are many reasons for this but the most common are excessive hinge gap or excessive slop in the pushrod connections and control horns. If you ever hear a low-pitched buzzing sound, reduce throttle and land immediately.

Foam Rubber - A soft foam material used to wrap the *receiver* and airborne battery for vibration dampening in the airplane.

Frequency Control - The FCC has allowed the 72Mhz band to be used for R/C aircraft operations. This band is divided up into many different channels in which you can choose a radio system. You should be aware that certain areas have frequencies in which there is pager interference. This is why it is always a wise move to check with your local hobby shop to find out any channels that may be troublesome in the area you wish to fly.

Fuel Over Flow Line (Vent) - The fuel line is either open to atmospheric pressure or attaches to the muffler pressure nipple to pressurize the *fuel tank* for better fuel flow to the engine. This is the line through which the fuel will overflow when the tank is full.

Fuel Pick Up Line - The fuel line in the *fuel tank* through which the fuel travels to the *carburetor*. Typically a flexible tube with a weight or "Clunk" on the end which allows it to follow the fuel with changes in aircraft altitude. This is the line through which the tank is filled.

Fuel Tank - The container which holds the fuel in an airplane.

Fuselage-The body of an airplane.

Fun Fly Airplane - A specialty model designed to be very lightweight and perform very tight, rapid, maneuvers such as loops and rolls.

Glow Plug Clip/Battery - A 1.2 volt battery', which is connected to the glow plug on a model airplane engine for starting. The battery is removed once the *engine is running steadily*.

High Wing - An airplane with the wing mounted on top of *the fuselage*.

Hinge-A flexible or hinged blade which is glued into a control surface and trailing edge to allow control surface deflection or movement. Note: It is extremely important that all hinges are permanently glued into both the control surface and trailing edge. Improper gluing will cause a crash.

Horizontal Stabilizer - The horizontal tail surface at the back of the *fuselage* which provides aerodynamic pitch stability and control to the airplane.

Lateral Balance - The point at which the airplane balances side to side. An airplane that is laterally balanced will track better through loops and other maneuvers.

Leading Edge (LE) - The very front edge of the wing or stabilizer. This is the edge that hits the air first.

Low Wing- An airplane with the wing mounted on the bottom of *the fuselage*.

Main Landing Gear - The landing gear and wheels which are usually on the bottom of *the fuselage* under the wing on a high wing airplane, or on the bottom of the wing on a low wing airplane.

Mid Wing - An airplane with the wing mounted in the center of *the fuselage*, between the top and bottom.

Muffler - A device attached to the exhaust stack of the *engine* to reduce noise, and increase back pressure which helps low speed performance. Note: Most R/C Clubs require the use of mufflers.

Needle Valve - Adjustment on a *carburetor* used to set proper fuel mixture. Some carburetors have separate needle adjustments for low and high throttle. Typically turning the needle clockwise (screwing in) leans the mixture and vice versa. However, there are a few exceptions—refer to the *engine manufacturer's* instructions.

NiCd - Nickel Cadmium battery. Rechargeable batteries which are typically used as power for radio control *transmitters and receivers*.

Nitro - NitroMethane, a fuel additive which increases a model airplane's ability to idle low and improves high speed performance. Ideal nitro content varies from *engine* to engine. Refer to the engine manufacturers' instructions for best results. Nitro content in fuel is indicated by the percent of the fuel.

Ni-starter- A self-contained battery and glow-plug clip, used when starting the engine.

Nose Gear - The landing gear at the nose of the airplane if the airplane is a Tricycle landing gear type. Typically connected to the *rudder servo* for ground steering.

One point landing - synonymous with "stuffing it in."

Pitch Axis - The airplane axis controlled by the *elevator*. Pitch is illustrated by holding the airplane.

at each wingtip. Raising or lowering the nose is the pitch movement. This is how the climb or dive is controlled.

Power panel - 12 volt distribution panel that provides correct voltage for accessories like glow-plug clips, fuel pumps and electric starters. Usually mounted on a field box and connected to a 12 volt battery.

Pushrod-A rigid piece of wood, fiberglass, nylon or steel used to transfer movement from a *servo* to a control surface or throttle.

Receiver (Rx) - The radio unit in the airplane which receives the *transmitter* signal and relays the control to the *servos*. This is somewhat similar to the radio you may have in your family automobile, except the radio in the airplane perceives commands from the transmitter and the radio in your car perceives music from the radio station.

Roll Axis - The airplane axis controlled by the *ailerons*. Roll is illustrated by holding the airplane by the nose and tail. Dropping either wingtip is the roll movement. This is used to bank or turn the airplane.

Rudder-Hinged control surface located at the trailing edge of the *vertical stabilizer*, which provides control of the airplane about the *Yaw axis* and causes the airplane to Yaw left or right. Left *rudder* movement causes the airplane to Yaw left and right rudder movement causes it to Yaw right.

Servo - The electronic/ mechanical device which moves the control surfaces or throttle of the airplane according to commands from the *receiver*. The radio device which

does the physical work inside the airplane.

Servo Output Arm - The removable arm or wheel which bolts to the output shaft of a servo and connects to the *pushrod*

Solo: Your first totally unassisted flight that results in a controlled landing.

Spinner - The nose cone which covers the hub of the propeller.

Sport Airplane - A model which possesses some attributes of many of the specialty airplanes and are best for general flying as they are the most versatile and durable.

Stall: What happens when the angle of attack is too great for the forward speed of the wing. The wing stops producing enough lift to sustain flight, which causes the nose to pitch downward. Once airspeed is regained the wing will recover.

Switch Harness - The on/off switch for the *flight pack*, which is mounted in an accessible location on the *fuselage*.

Tachometer - An optical sensor designed specifically to count light impulses through a turning propeller and read out the engine RPM.

Tail Wheel - The wheel at the tail of the airplane on standard landing gear or tail dragger type airplanes. Steering is typically coupled to the *rudder* for ground handling.

Threaded Horns - Small nylon horns which thread onto the threaded portion of the *aileron torque rods* and connect to the *clevis* of the *aileron pushrods*.

Torque Rods - Rigid bent wire rods inserted into *ailerons*, running

along the wing trailing edge and bent down to connect to the *aileron servo push rods*.

Trailing Edge (TE) - The very aft edge of the wing or stabilizer.

Trainer Airplane - A model designed to be inherently stable and fly at low speeds, to give first time modelers time to think and react as they learn to fly.

Transmitter (Tx) - The hand held radio controller. This is the unit that sends out the commands that you input.

Transmitter Modes -

Mode I. Left hand stick controls *elevator* and *rudder*. Right hand stick controls throttle and *aileron*.

Mode II. Left hand stick controls throttle and *rudder*. Right hand stick controls *elevator* and *aileron*. Mode II is by far the most popular in the United States.

V-Tail - An airplane which has two tail surfaces in the shape of a V, in lieu of a *vertical stabilizer* and *horizontal stabilizer*, the control surfaces on a V-tail are called *rudervators* and function both in the same direction as an *elevator* and in opposite directions as a *rudder*.

Vertical Fin - The non-moving surface that is perpendicular to the *horizontal stabilizer* and provides lateral stability. This is the surface the *rudder* attaches to.

Wheel Collar - A small, round retaining device used to keep wheels from sliding off an axle.

Wing - The main lifting surface of an airplane.

Wing Loading - This is the amount of weight per square foot that has to be overcome to provide lift. It is normally expressed in ounces per square foot. This specification can be easily calculated as follows: If you know the square inches of the wing, simply divide by 144 to obtain square feet. Divide the total weight (in ounces) of the airplane by the wing area (in square feet). This information is valuable when deciding on which airplane to build next. Planes with high wing loading numbers must fly faster to stay in the air. These are generally "performance" airplanes. Conversely, planes with lower numbers do not need as much air flowing around the wing to keep it flying. Gliders and trainer airplanes fall into this category because slow, efficient flight is desirable.

Yaw Axis - The airplane axis controlled by the *rudder*. Yaw is illustrated by hanging the airplane level by a wire located at the center of gravity. Left or right movement of the nose is the Yaw movement. Many aircraft are not equipped with *ailerons* and the roll and Yaw axis are controlled by the *rudder*. This is due to the larger amount of *dihedral* in the wing. This is why most *trainer aircraft* have a larger amount of *dihedral*.

Z Bend - A simple Z shaped bend in the wire end of a *pushrod* which is used to attach the pushrod to a *servo output arm*.

Z Bend Pliers - An inexpensive plier type tool used for easily making perfect Z bends.