



Giant Scale **Cessna O-1 Bird Dog** **122" ARF 70-125cc**

Code : SEA385

ASSEMBLY MANUAL

“Graphics and specifications may change without notice”



Specifications:

Wingspan-----	122 in-----	310 cm.
Wing area-----	2017.8 sq.in-----	130.2 sq.dm.
Weight-----	36.4 lbs-----	16.5 kg.
Length-----	85 in-----	215.8 cm.
Engine size-----	70 - 125cc gasoline engine.	
Radio-----	8 channels with 8 digital servos.	

INTRODUCTION

Thank you for choosing the **Giant Scale Cessna O-1 Bird Dog 122" ARF 70-125cc** ARTF by **SG MODELS**. The **Giant Scale Cessna O-1 Bird Dog 122" ARF 70-125cc** was designed with the intermediate/advanced sport flyer in mind. It is a semi scale airplane which is easy to fly and quick to assemble. The airframe is conventionally built using balsa, plywood to make it stronger than the average ARTF, yet the design allows the aeroplane to be kept light. You will find that most of the work has been done for you already. The motor mount has been fitted and the hinges are pre-installed. Flying the **Giant Scale Cessna O-1 Bird Dog 122" ARF 70-125cc** is simply a joy.

This instruction manual is designed to help you build a great flying aeroplane. Please read this manual throughly before starting assembly of your **Giant Scale Cessna O-1 Bird Dog 122" ARF 70-125cc** Use the parts listing below to indentify all parts.

WARNING

Please be aware that this aeroplane is not a toy and if assembled or used incorrectly it is capable of causing injury to people or property. WHEN YOU FLY THIS AEROPLANE YOU ASSUME ALL RISK & REponsibility.

If you are inexperienced with basic R/C flight we strongly recommend you contact your R/C supplier and join your local R/C model Flying Club. R/C Model Flying Clubs offer a variety of training procedures designed to help the new pilot on his way to successful R/C flight. They will also be able to advise on any insurance and safety regulations that may apply.

KIT CONTENTS

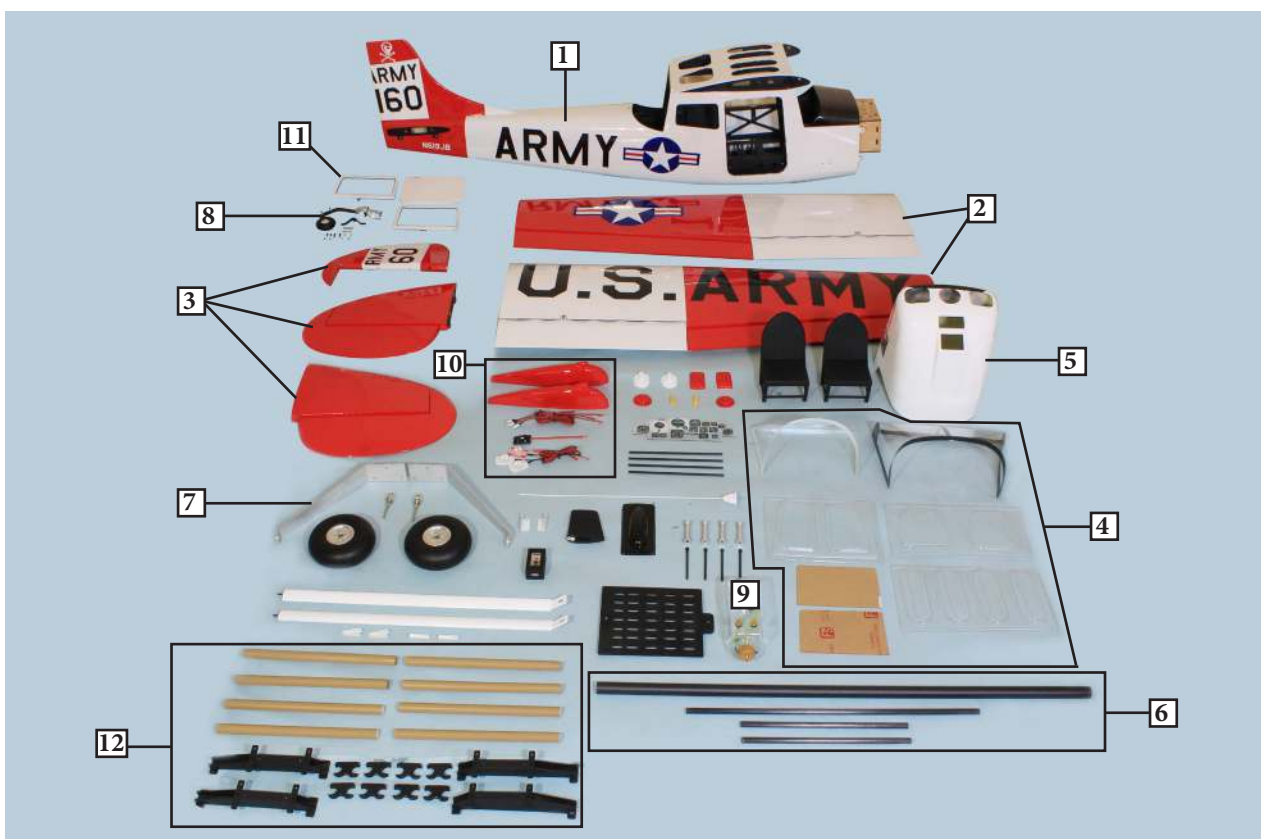

KIT CONTENTS

SEA385 Giant Scale Cessna O-1 Bird Dog 122" ARF 70-125cc

1. Fuselage
2. Wing set (2)
3. Tail set (3)
4. Canopy
5. Cowling
6. Wing tube
7. Landing gear
8. Tail wheel
9. Fuel tank
10. Led light set
11. Windows
14. Rockets (2)

ADDITIONAL ITEMS REQUIRED

- 70-125cc gasoline engine.
- Computer radio 8 channel with 8 servos.
- Glow plug to suit engine.
- Propeller to suit engine.
- Protective foam rubber for radio system.

TOOLS & SUPPLIES NEEDED

- Thin cyanoacrylate glue.
- Medium cyanoacrylate glue.
- 30 minute epoxy.
- 5 minute epoxy.
- Hand or electric drill.
- Assorted drill bits.
- Modelling knife.
- Straight edge ruler.
- 2mm ball driver.
- Phillips head screwdriver.
- 220 grit sandpaper.
- 90° square or builder's triangle.
- Wire cutters.
- Masking tape & T-pins.
- Thread-lock.
- Paper towels.

LED LIGHT SET

Please see pictures below.

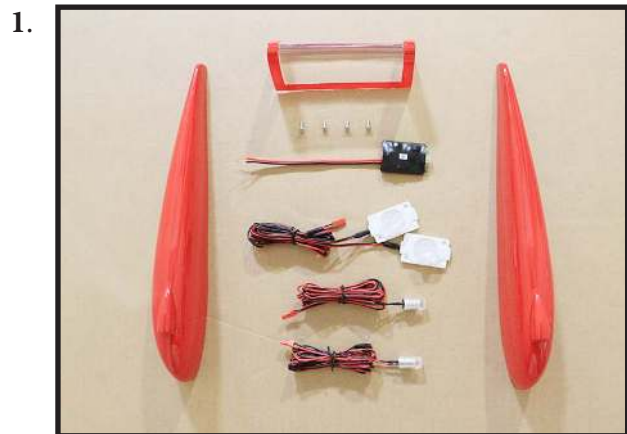

One the green light for right wing tip, two white light and the red light for left wing tip. They are designed to operate on voltages 12 volts. Connect four lights into switch circuit so that optional the different flashes mode.



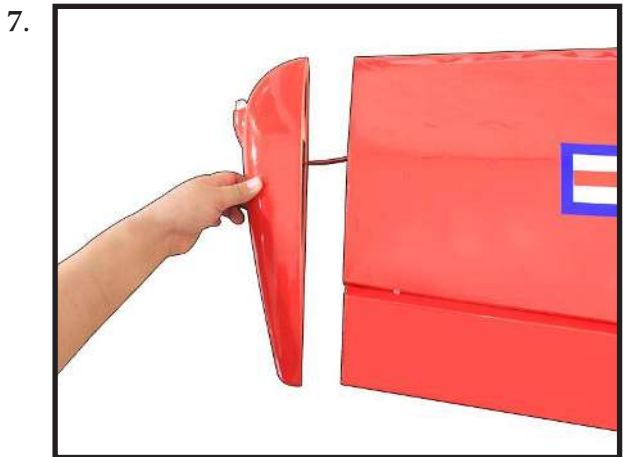
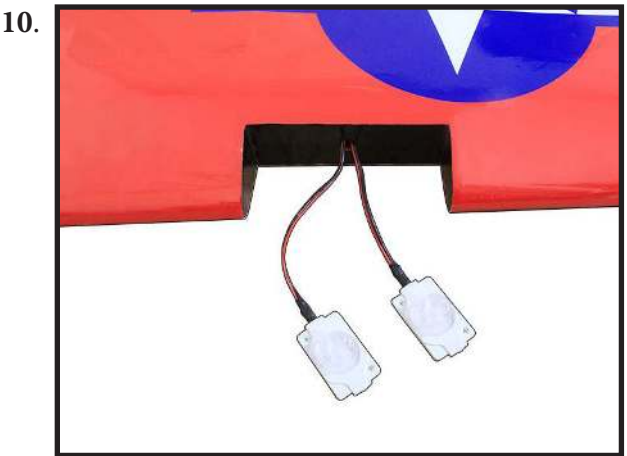
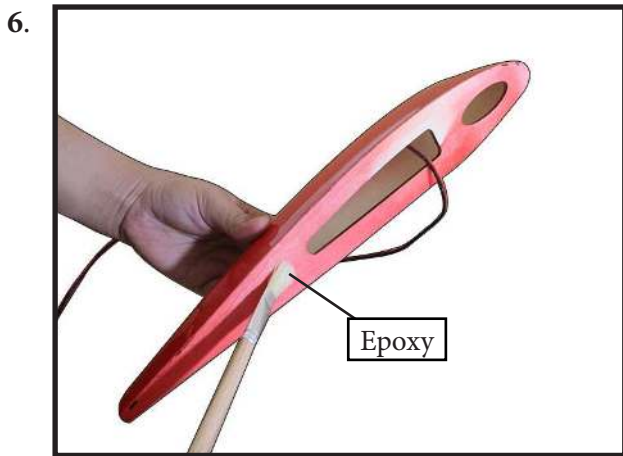
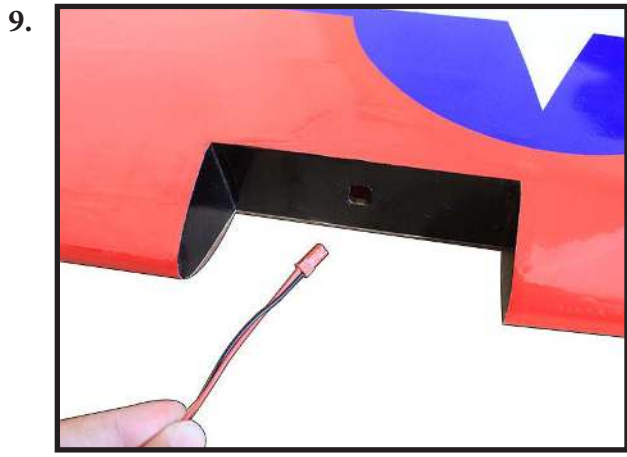
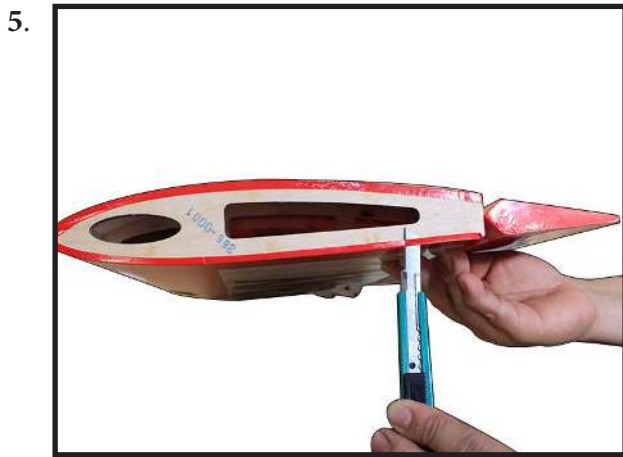
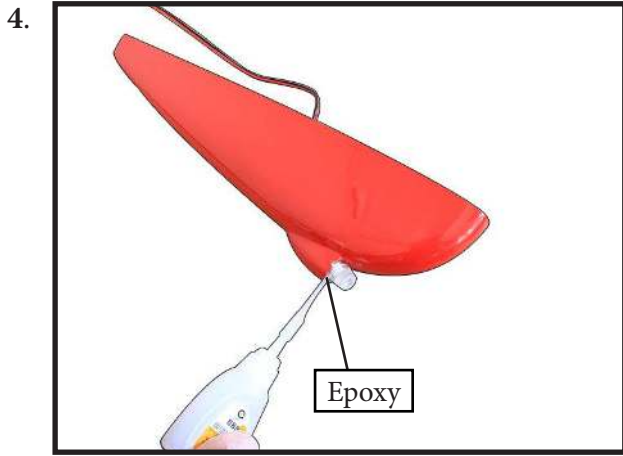

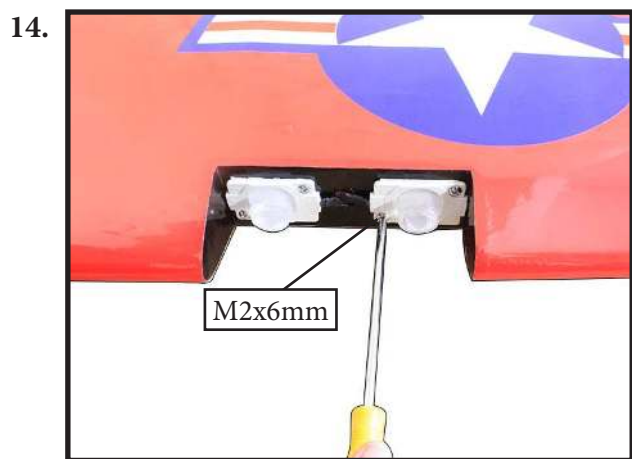
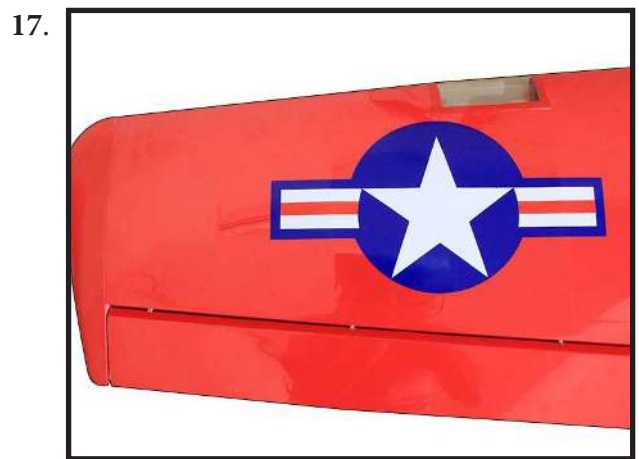
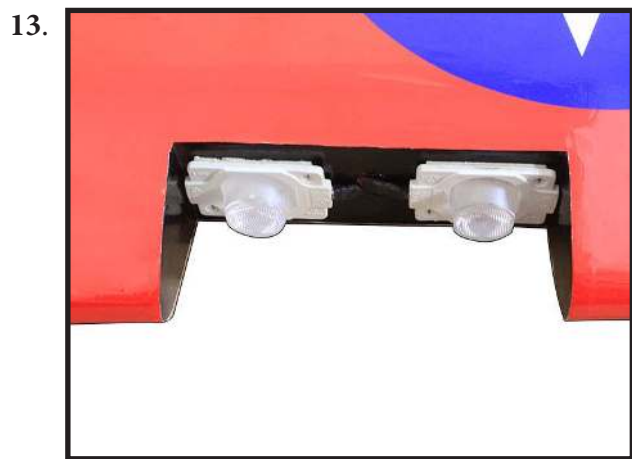
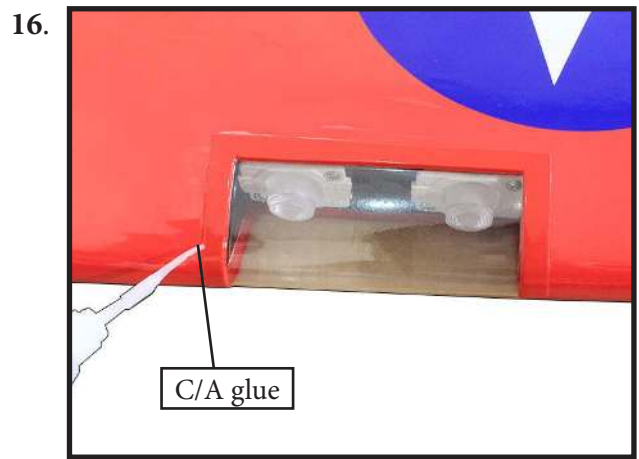
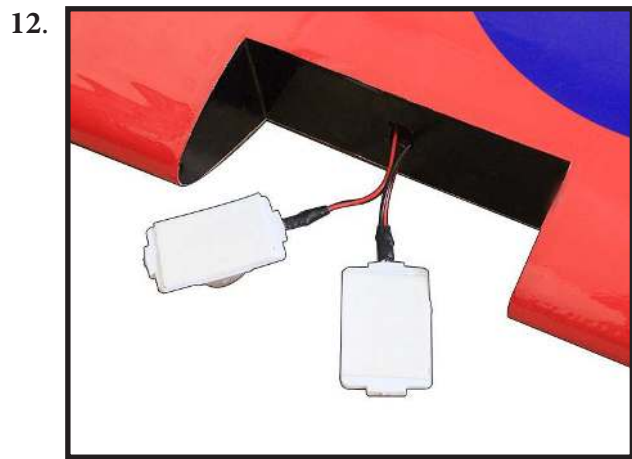

INSTALL THE AILERONS

Please see pictures below.

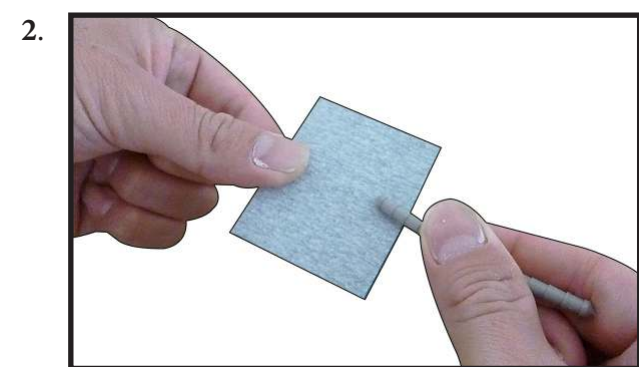
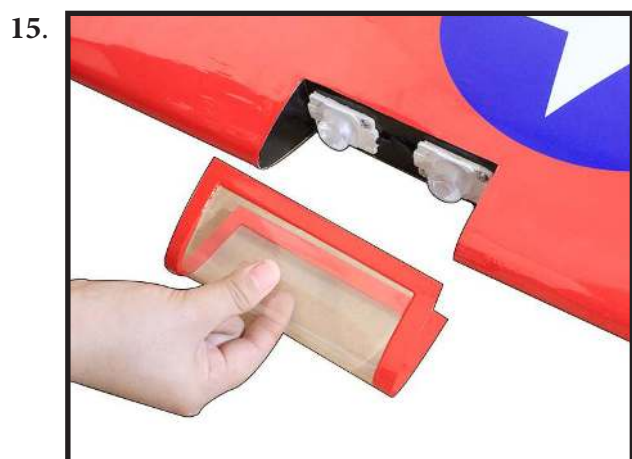
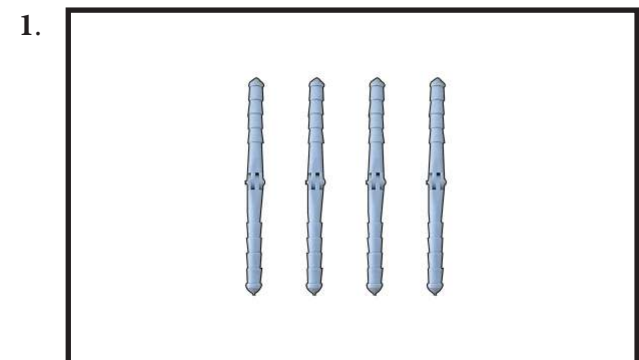

Remove the ailerons from the wing and remove the hinges.

Use a small piece of rough sandpaper to scuff the hinges for better epoxy adhesion. Do this to all aileron hinges.

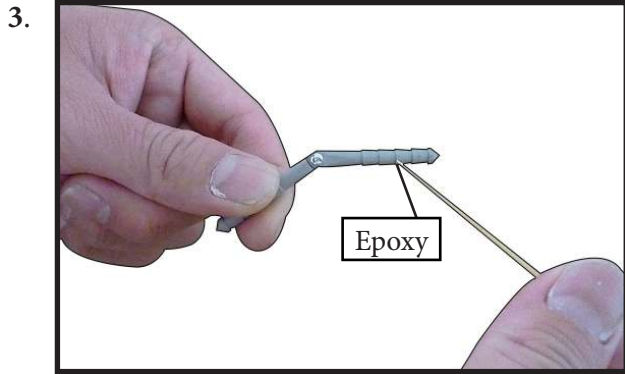

Apply epoxy to each hinge where it will be inserted into the ailerons. Tip: Apply some petroleum jelly to the metal pin hinge area to keep epoxy from interfering with smooth operation of hinge.



Insert all four hinges in the ailerons at this time. Make sure hinges move up and down in right direction and not side to side!

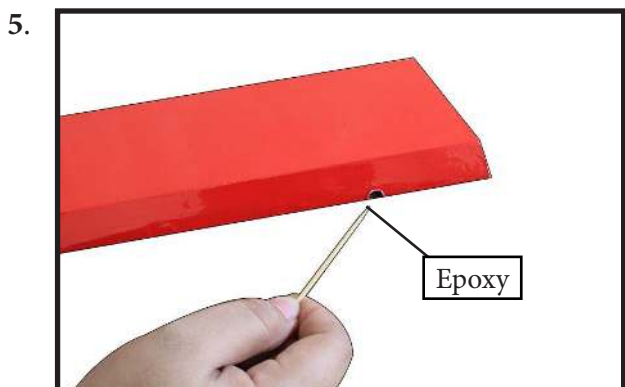

Apply epoxy into each of the holes in the ailerons using a spare piece of pushrod wire or toothpick.

Make sure to use enough epoxy so it securely adheres the hinge to the surfaces.

Do not use an excessive amount of epoxy when gluing the hinges so that it expels from the hinge area.

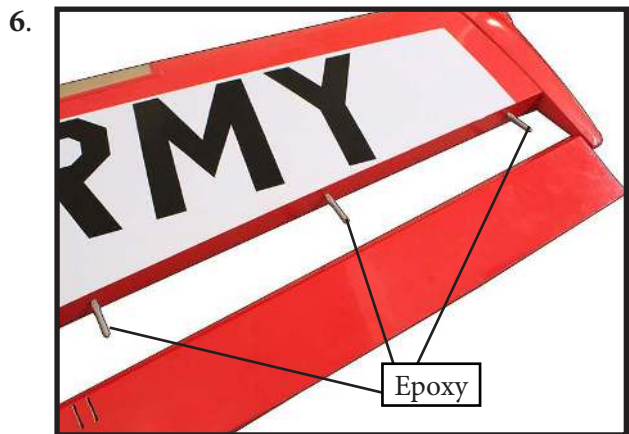

Be sure to test the aileron hinges once you insert them. Ensure that the hinge pockets line up, and that the hinges move freely before the epoxy dries.



Check the fit of the aileron to the wing. The top of the ailerons will align to the top of the wing. Make sure movement is smooth and bind free.

We prefer 30-minute epoxy to allow enough working time during the hinge installation.

INSTALL THE AILERONS CONTROL HORN

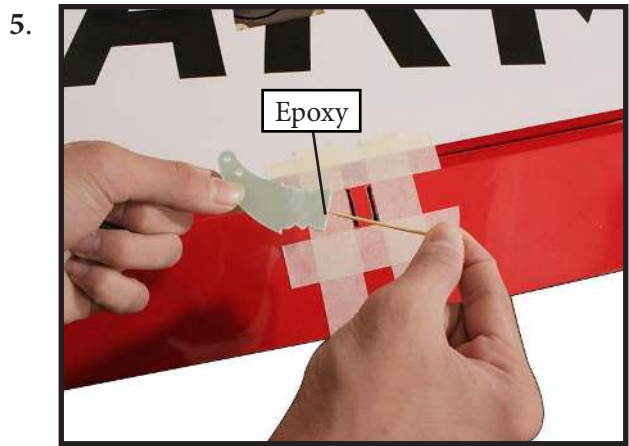
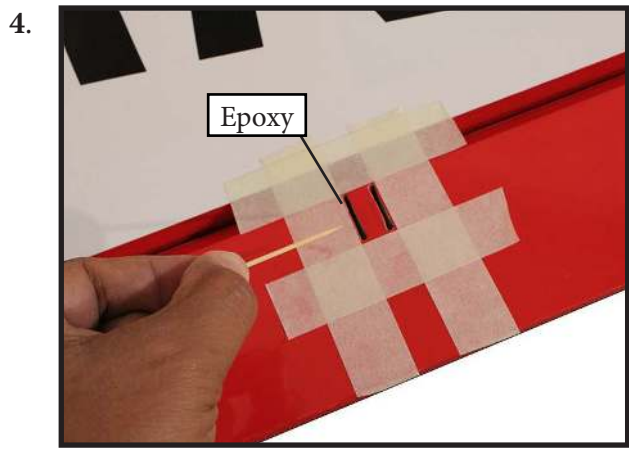
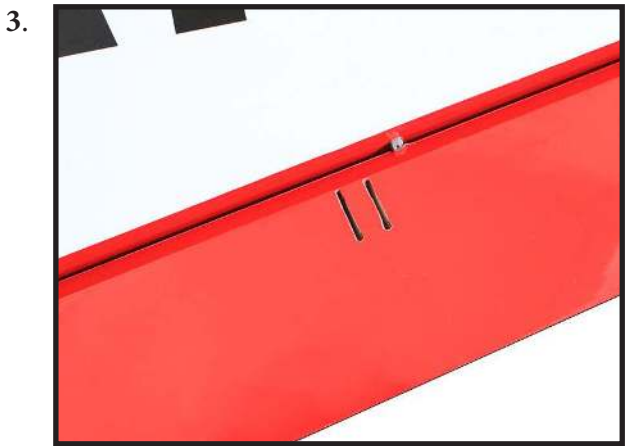
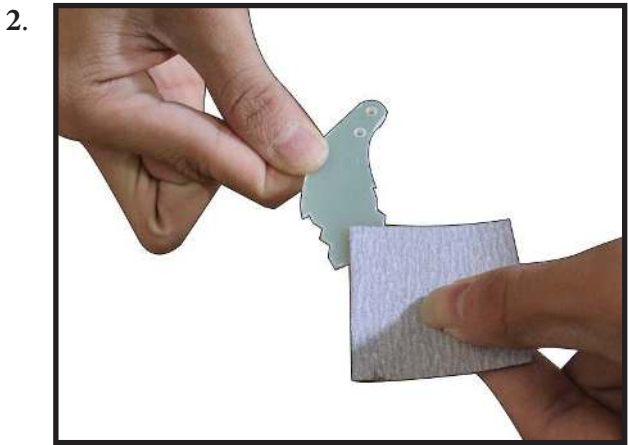
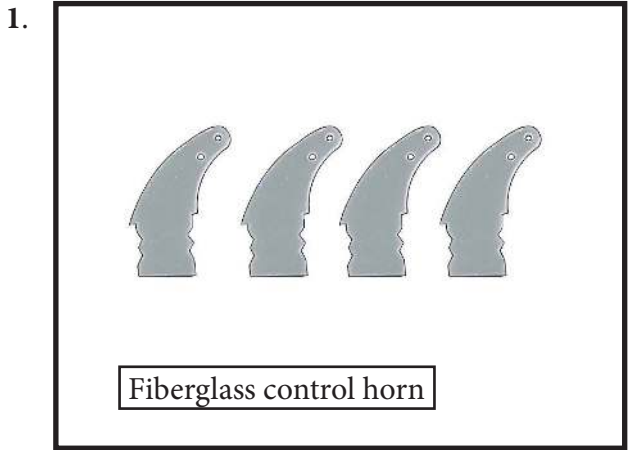

INSTALLING THE AILERON SERVOS

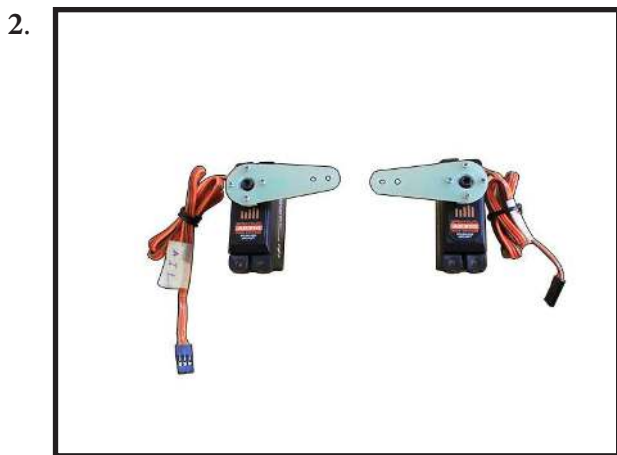
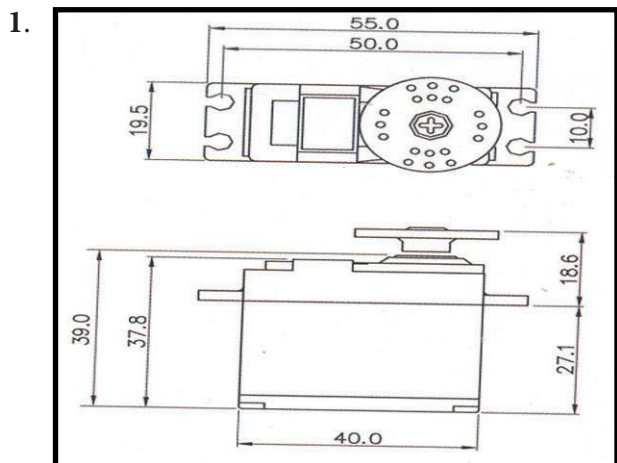

Minimum servo spec.
Torque : 27.3 kg-cm (378 oz-in) @6.0V
 33.7 kg-cm (467 oz-in) @7.4V
 38.2 kg-cm (530 oz-in) @8.4V
Transit Speed : 0.14 sec/60 @6.0V
 0.11 sec/60 @7.4V
 0.10 sec/60 @8.4V

Because the size of servos differ, you may need to adjust the size of the precut opening in the mount. The notch in the sides of the mount allow the servo lead to pass through.

Apply 2-3 drops of thin C/A to each of the mounting holes. Allow the C/A to cure without using accelerator.

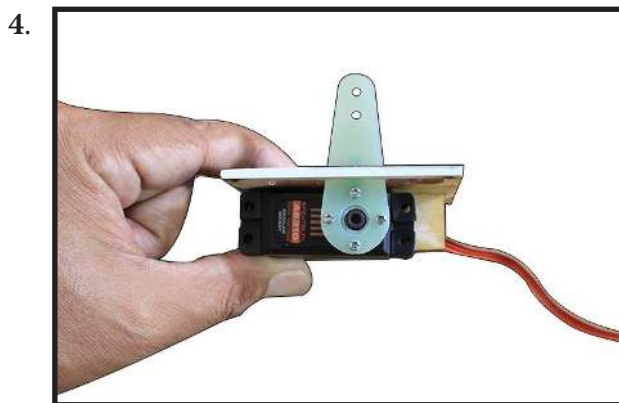
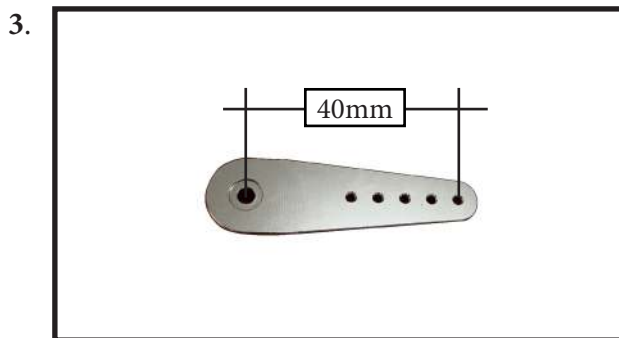

Use drill bit in a pin vise to drill the mouting holes in the blocks.

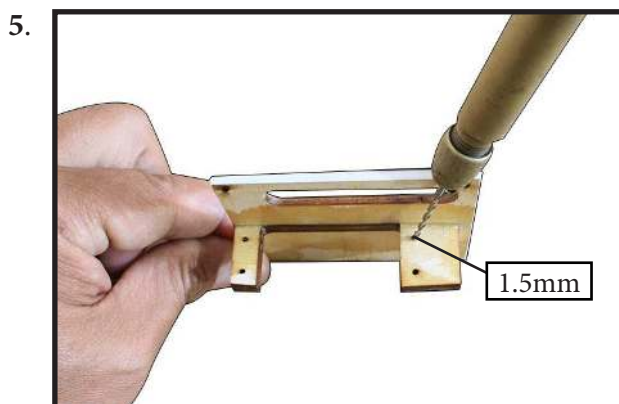

Apply 2-3 drops of thin C/A to each of the mounting holes. Allow the C/A to cure without using accelerator.

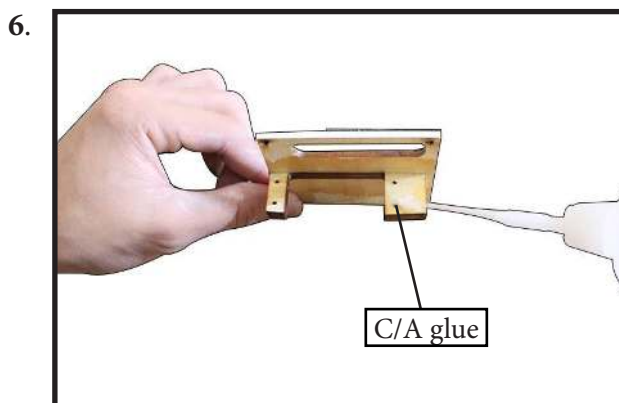

Use dental floss or heat shrink tubing to secure the connection between the servo and extension wire so they cannot become unplugged accidentally.

Use dental floss or heatshrink tube to secure the connection so they cannot become unplugged.

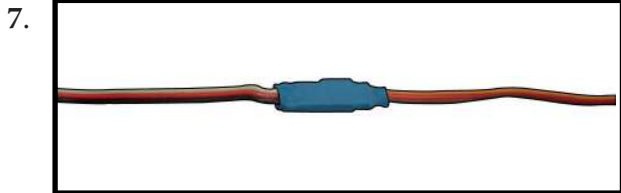

Secure the servo to the aileron hatch using Phillips screwdriver and the screws provided with the servo.

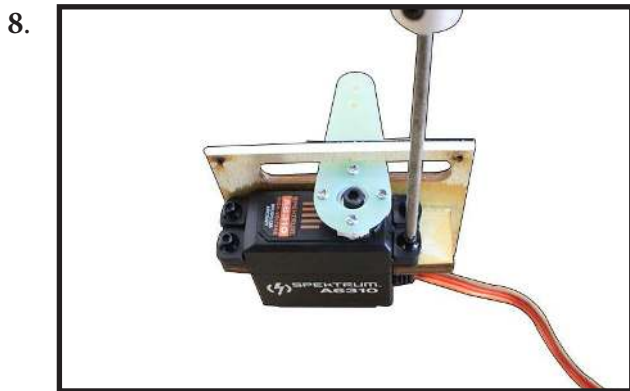

Apply 1-2 drops of thin C/A to each of the mounting tabs. Allow the C/A to cure without using accelerator.

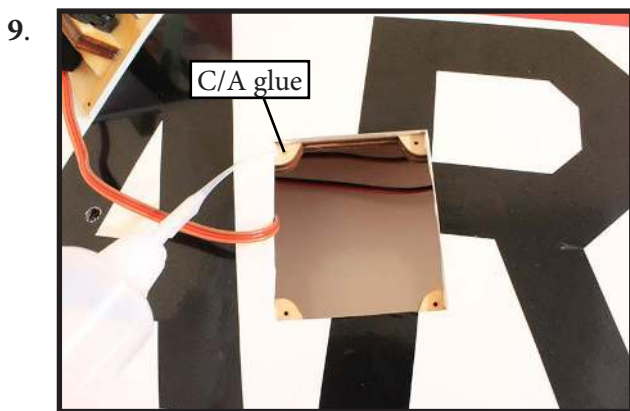

Remove the string from the wing at the servo location and use the tape to attach it to the servo extension lead. Pull the lead through the wing and remove the string.

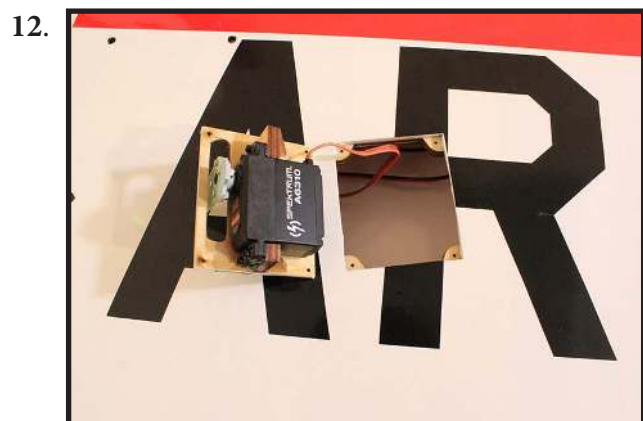
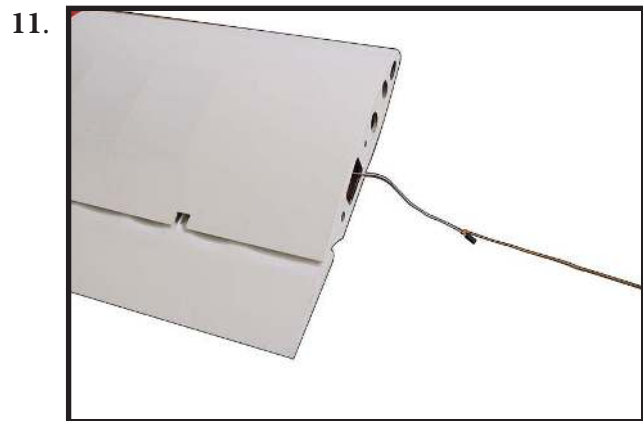

Set the aileron hatch in place and use a Phillips screw driver to install it with four wood screws.

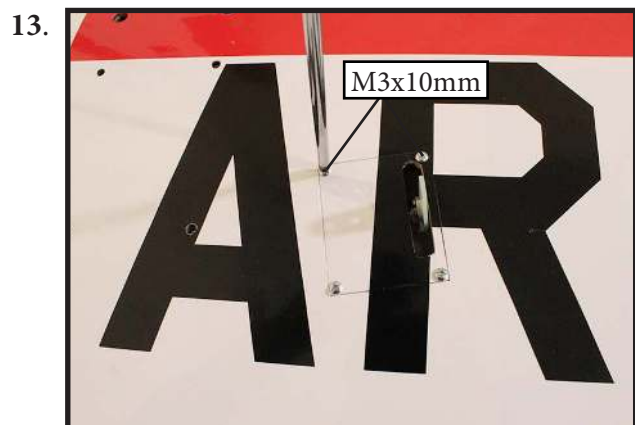



AILERON PUSHROD INSTALLATION



INSTALLING THE FLAP PUSHROD

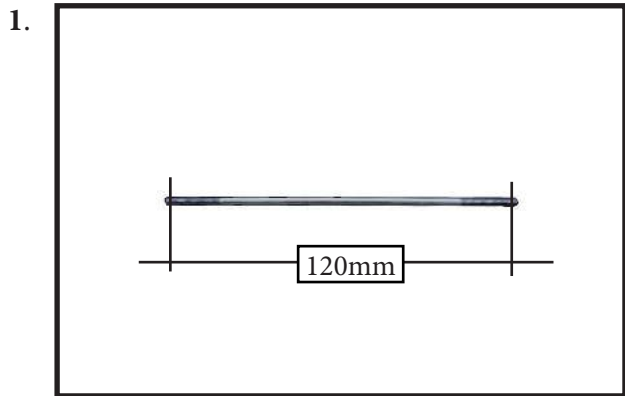

Please see below pictures.

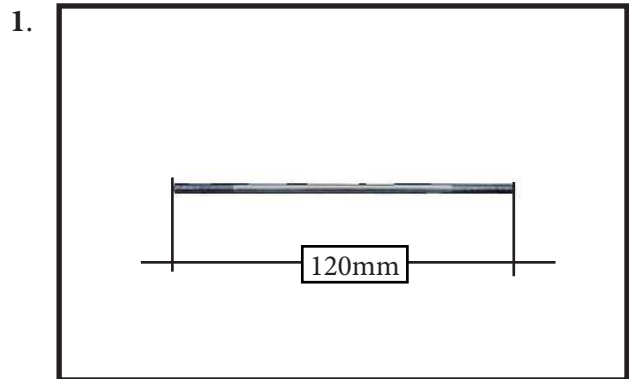

Attach the flap servo to the flap servo cover. Center the flap servo (or set the values to 0 for both up and down) and install the servo arm perpendicular to the servo centerline. The clevis will attach to the arm 13/16 inches (21mm) from the center of the arm.

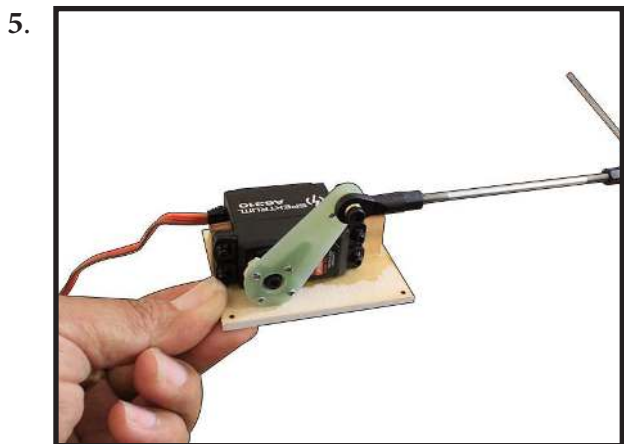
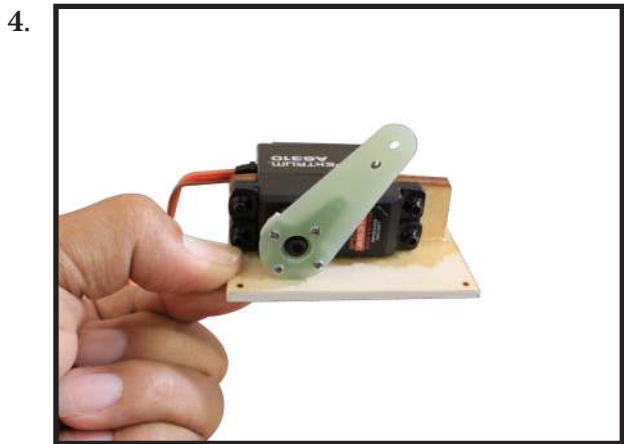

Attach the flap linkage to the control horn. Slide the clevis retainer over the forks of the clevis.

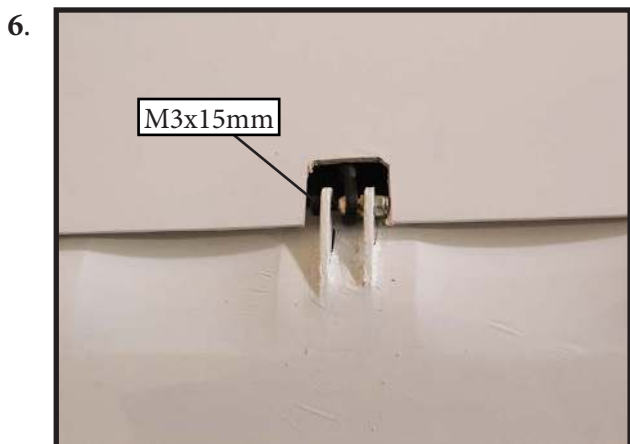

Attach the clevis to the flap servo arm.

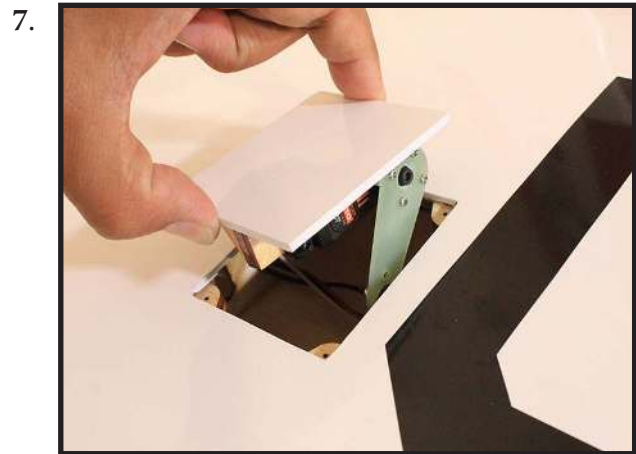

Use a pin vise and 3/32-inch (2mm) drill bit to clear the paint from the flap control horn.



Route the servo lead for the flap servo out at the root of the wing. Connect the flap servo to the radio system. With the radio system on, place the flap servo into position.

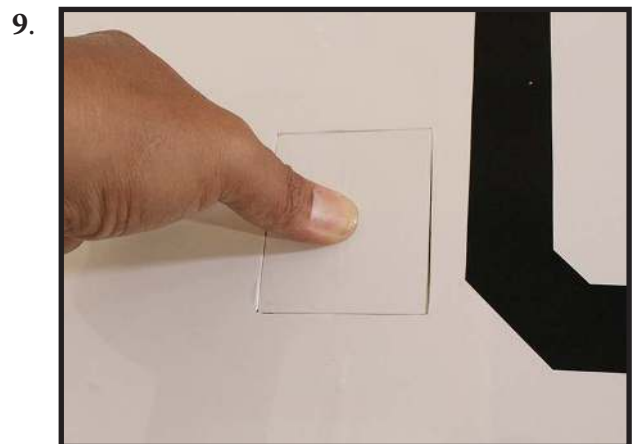

Once adjusted, make sure all clevis retainers are in position. Apply a drop of threadlock near the clevis, then tighten the nut against the clevis to keep the linkage from changing length inside the wing.

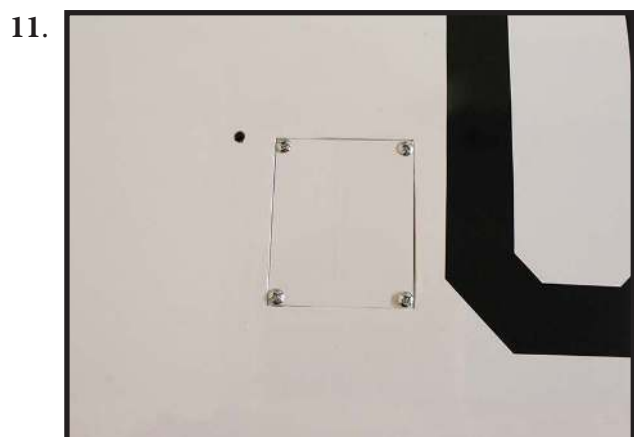
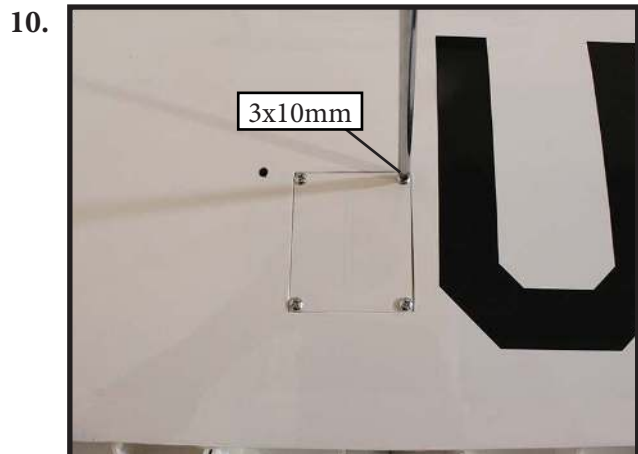

Trim the flap linkage cover using a hobby knife, hobby scissors and some fine sandpaper as needed.

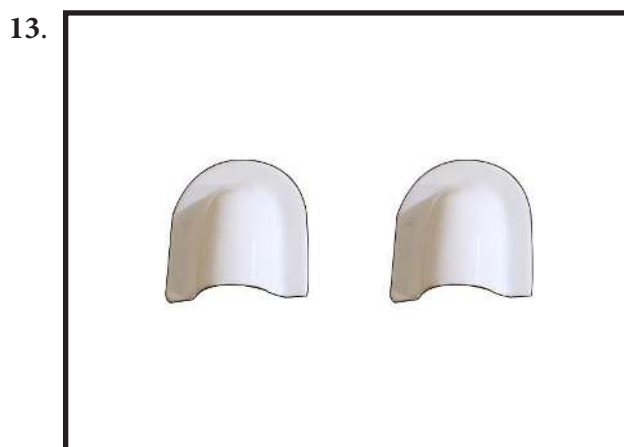
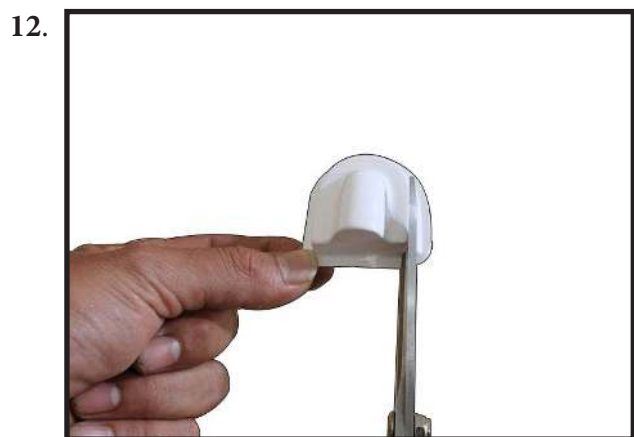

Fit the flap linkage cover into position. Check the operation of the flap to make sure the cover does not interfere with the flap linkage.



Use canopy glue to attach the cover to the wing. Use low-tack tape to keep the cover in position until the adhesive fully cures. Blue painters tape works well !

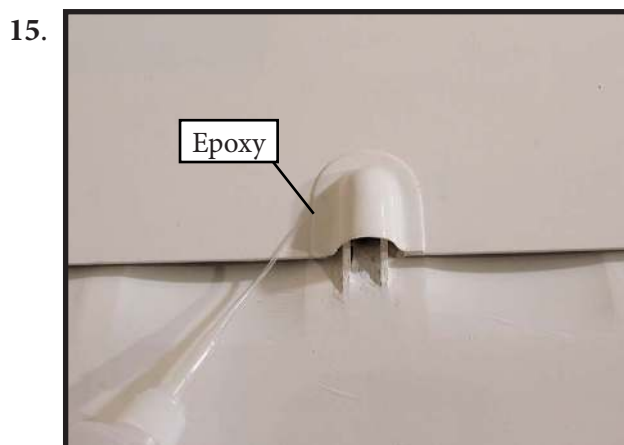

Install plastic ribs.

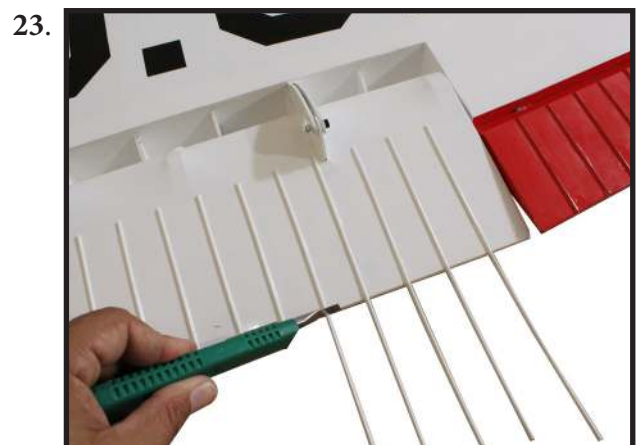
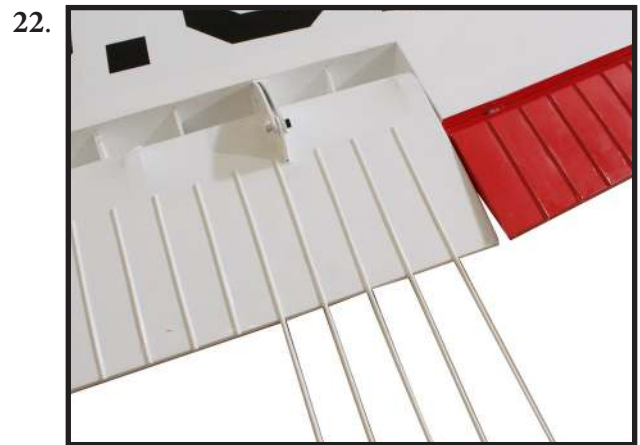
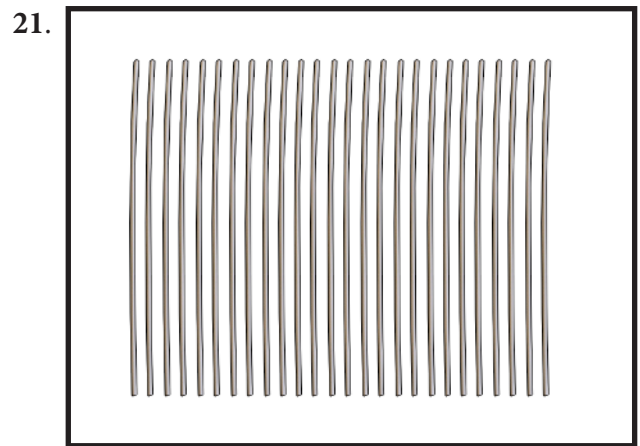
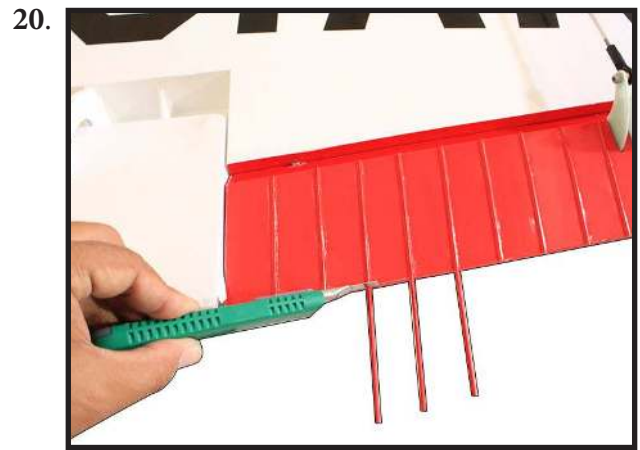
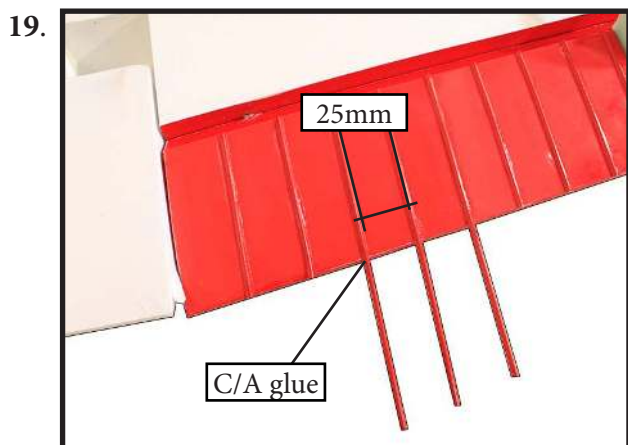
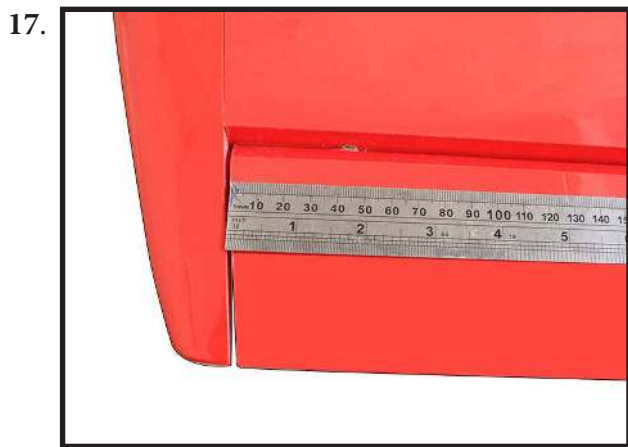
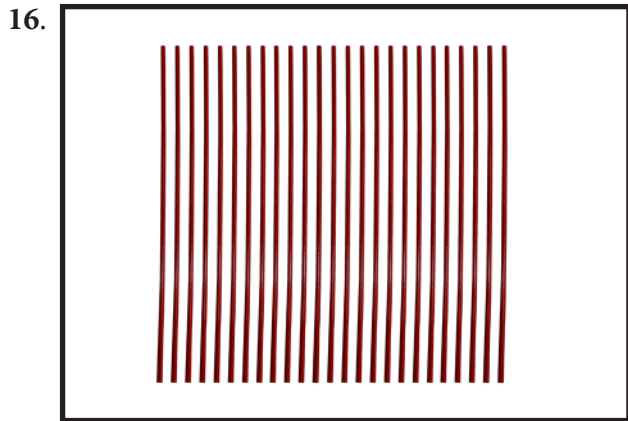

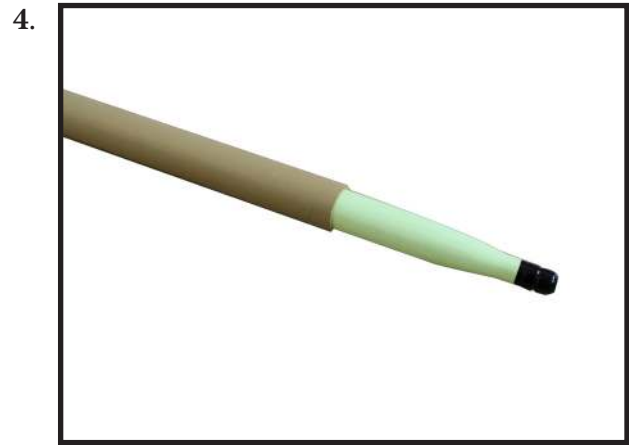

ROCKETS INSTALLATION

Please study images below.

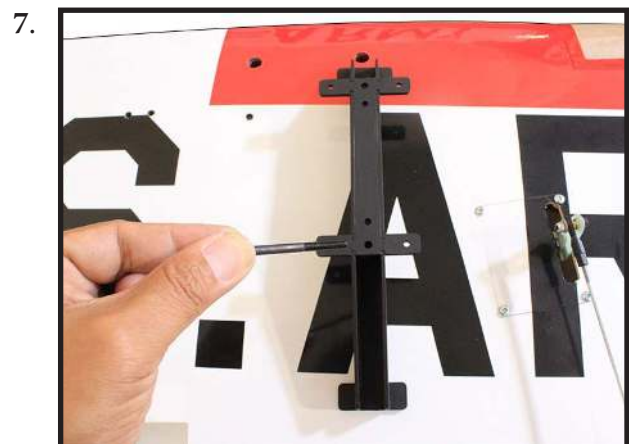
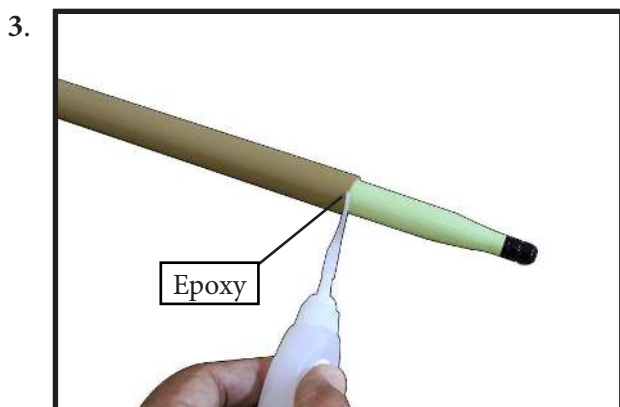
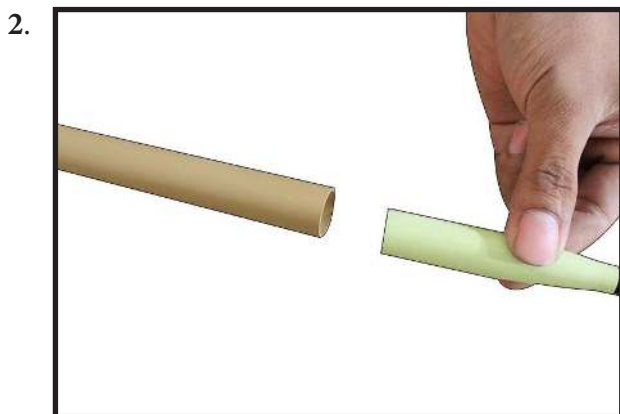
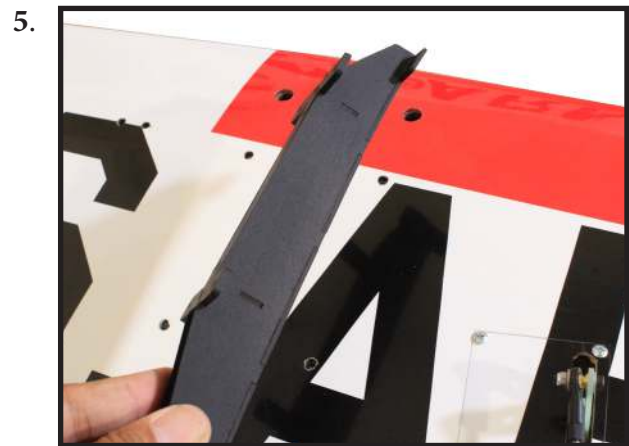

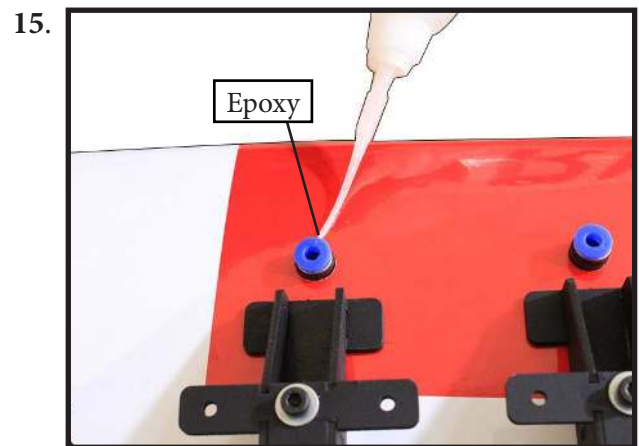
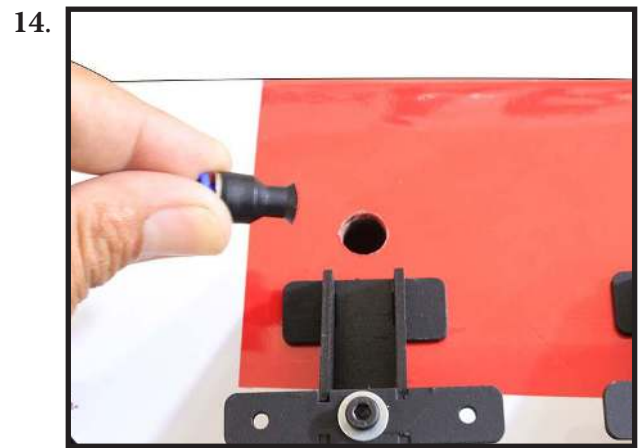
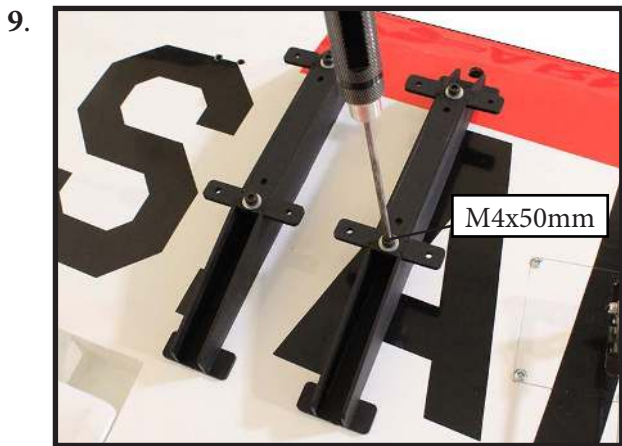
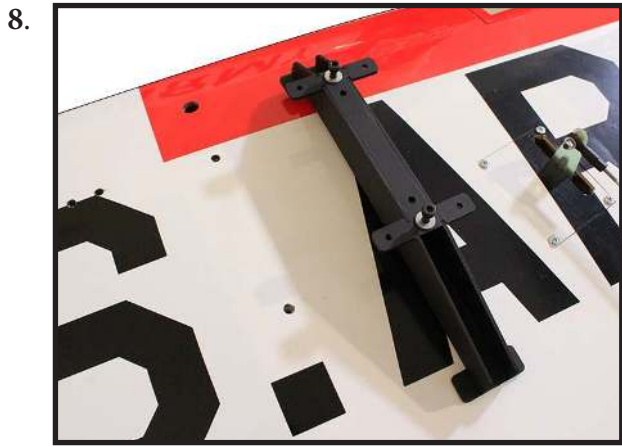

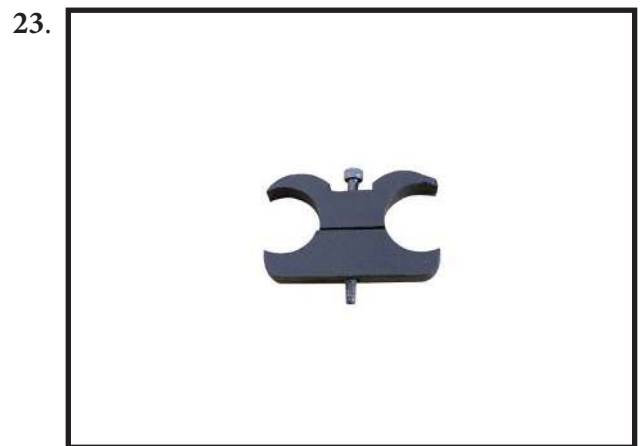
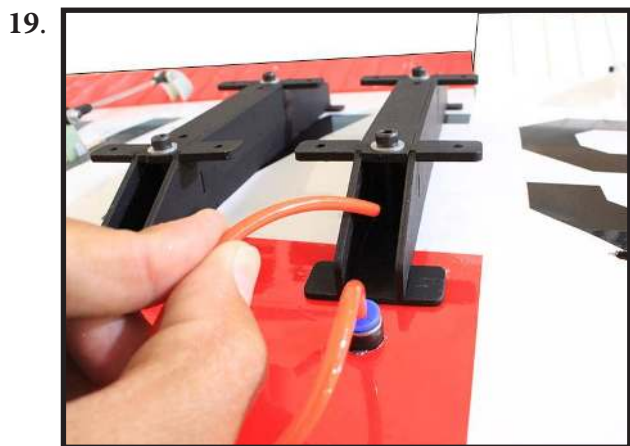
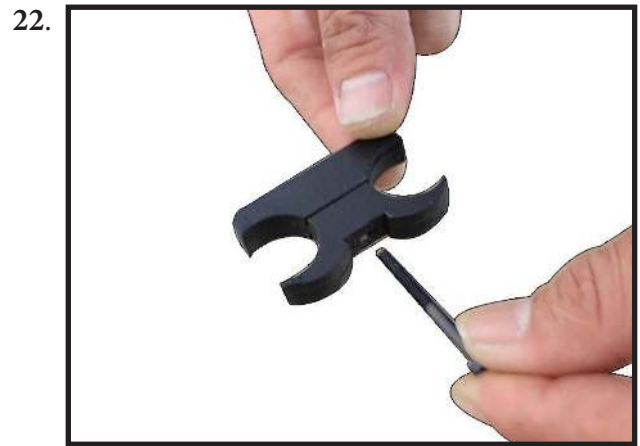
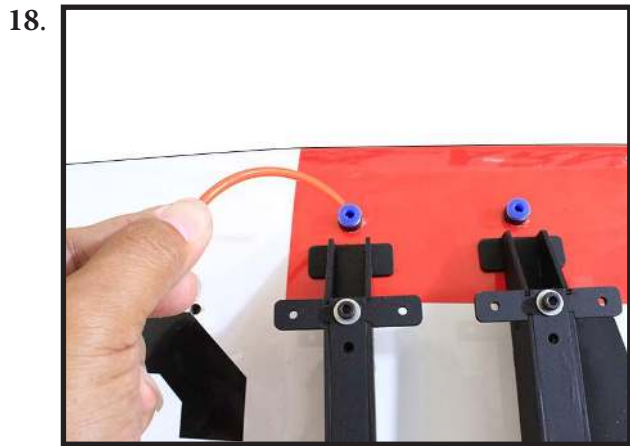
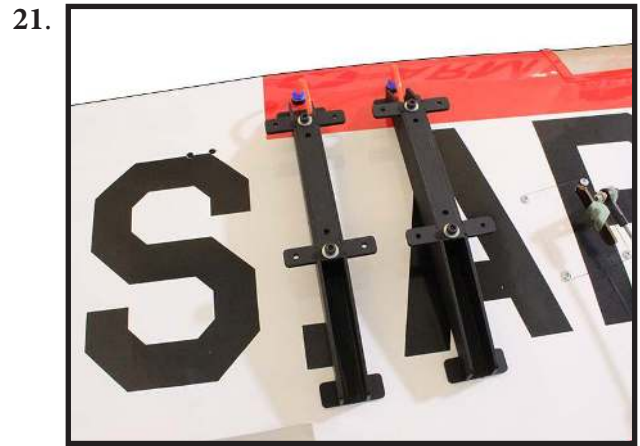
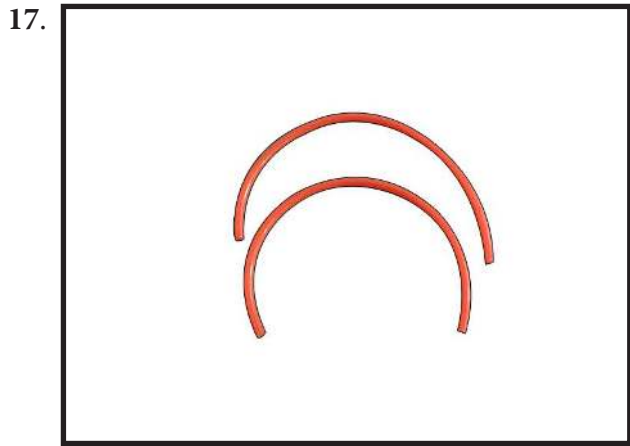
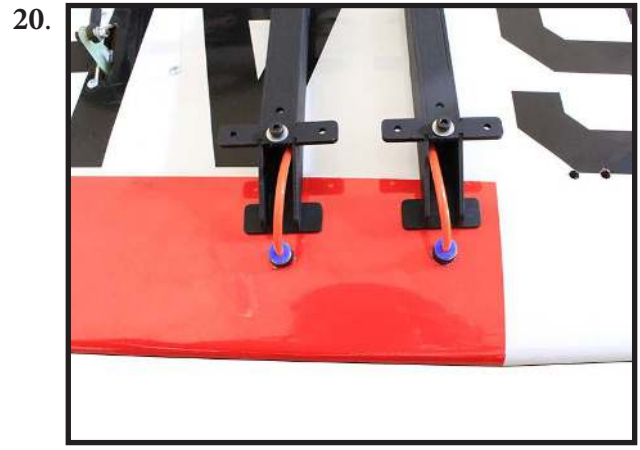
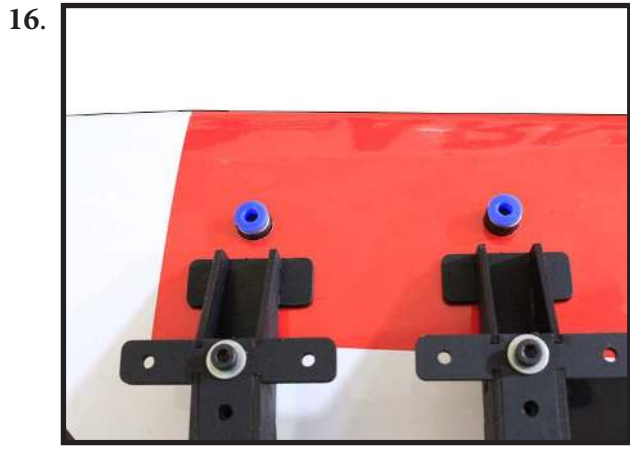

24.



28.

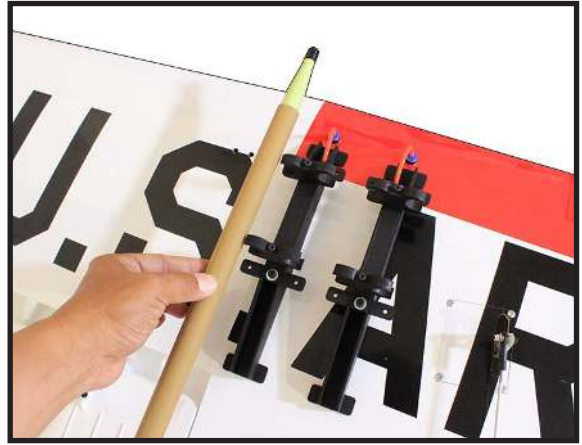

25.

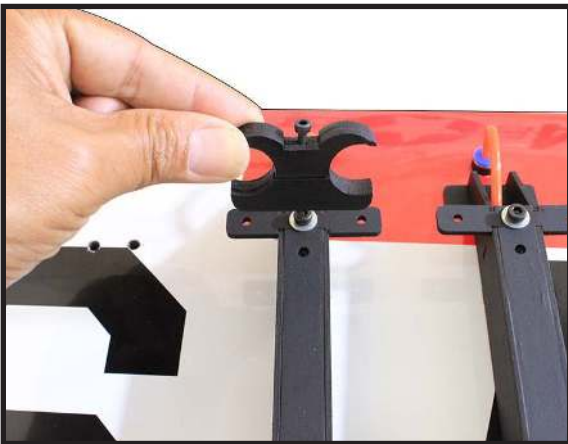

29.

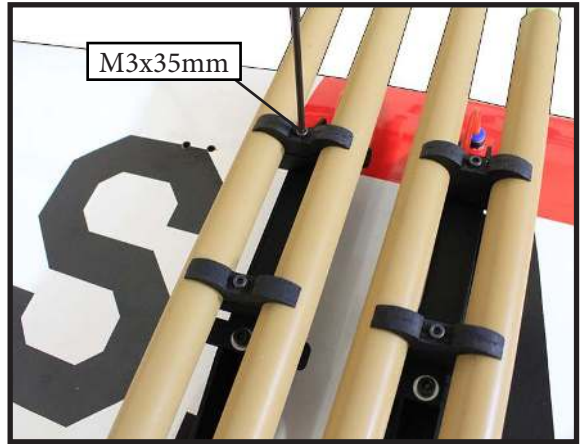

26.

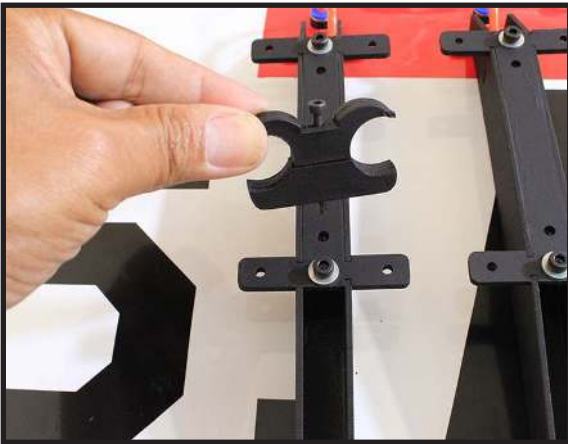

30.



27.

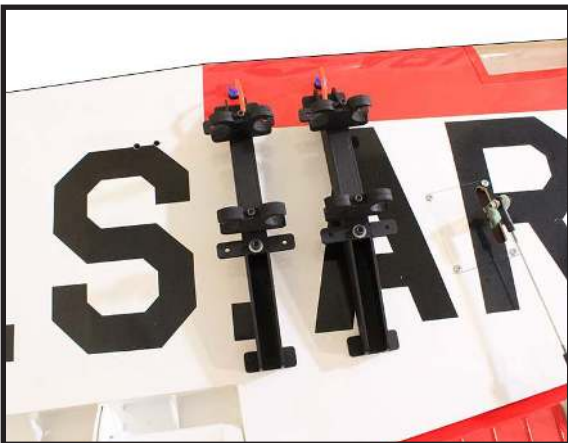

31.

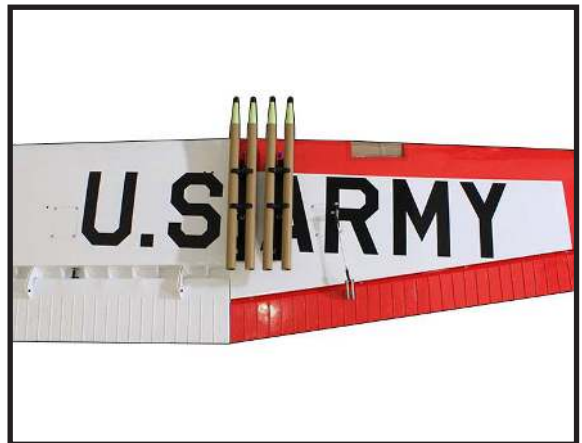

Then, install struts on the wings and fuselage.

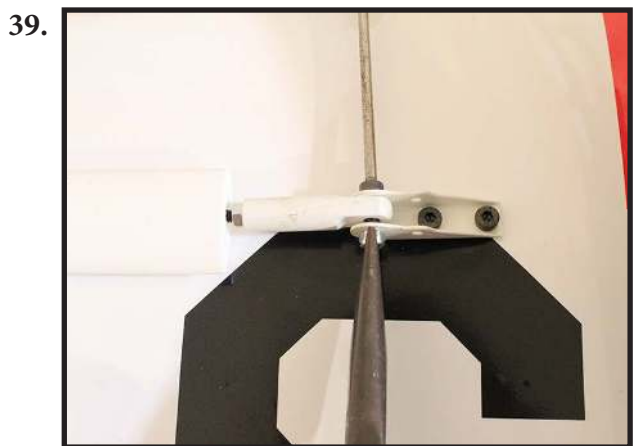
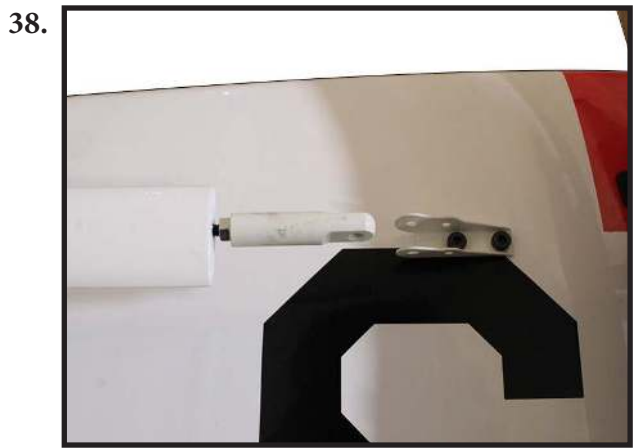
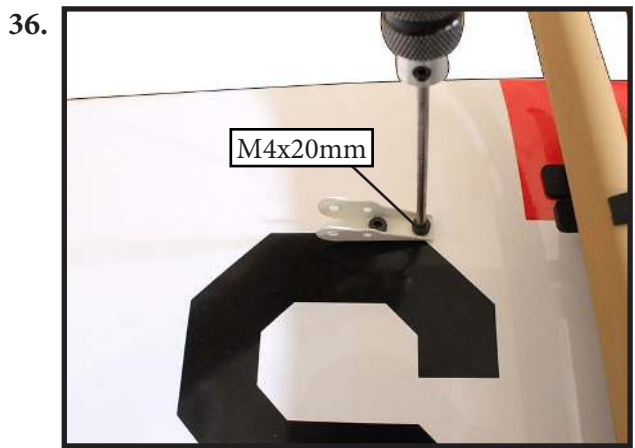
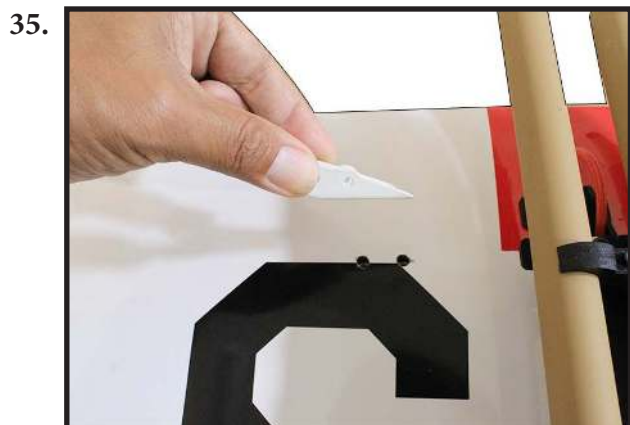
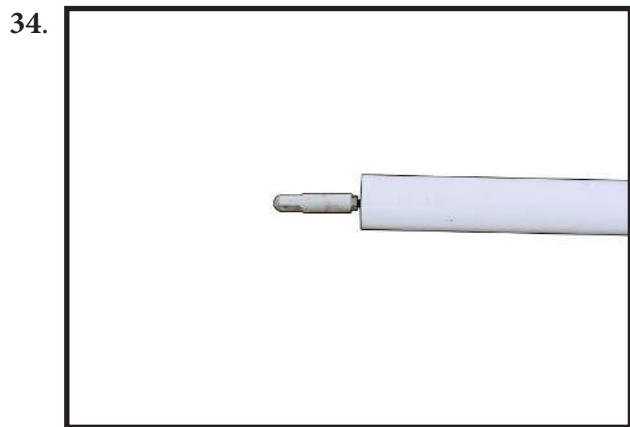
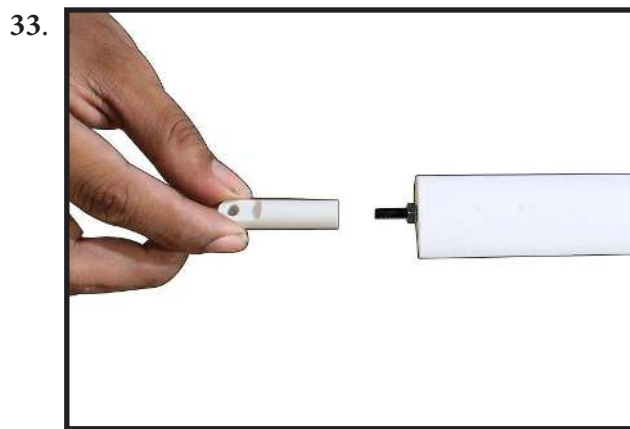
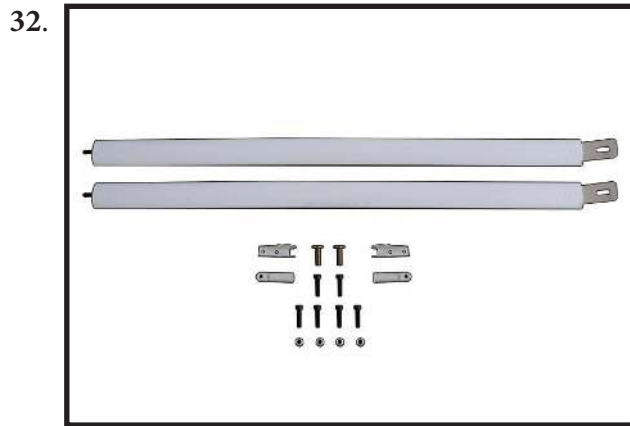

40.



INSTALL ELEVATOR HINGES

Test fit the hinges into the elevator, and then the hinges into the horizontal stabilizer. Ensure that the hinge pockets line up, and that the hinges move freely. Epoxy hinges the same way you did the aileron hinges.

1.

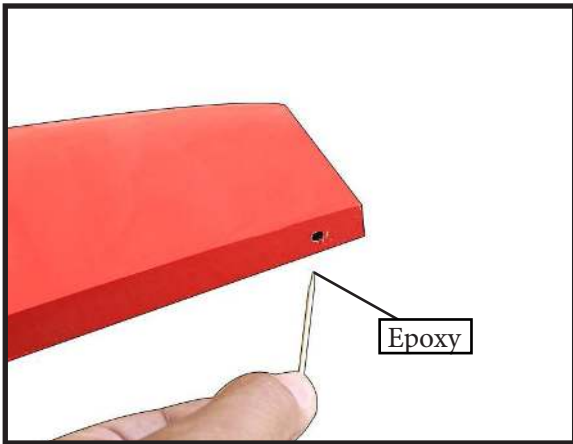

2.

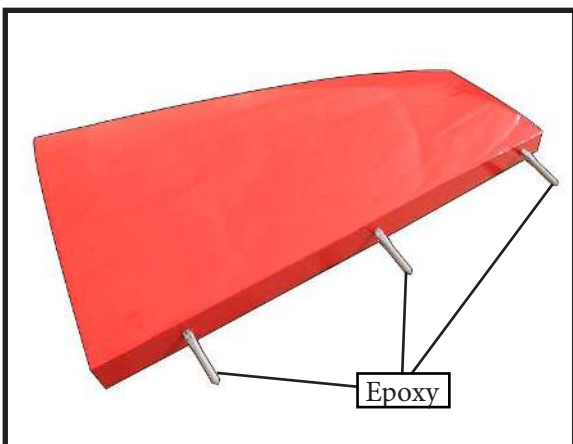

3.

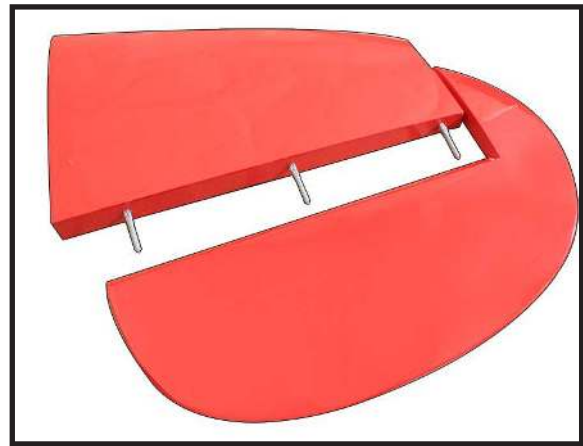

4.



INSTALL ELEVATOR CONTROL HORN

Install the elevator control horn using the same method as same as the elevator control horns.

1.

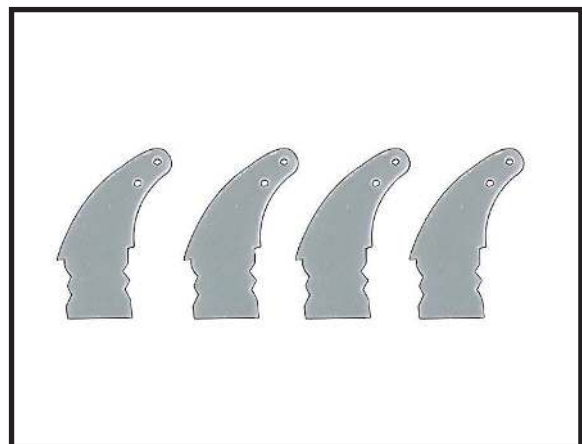

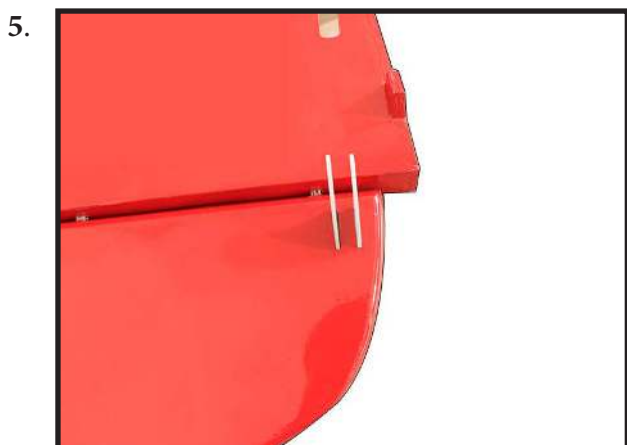
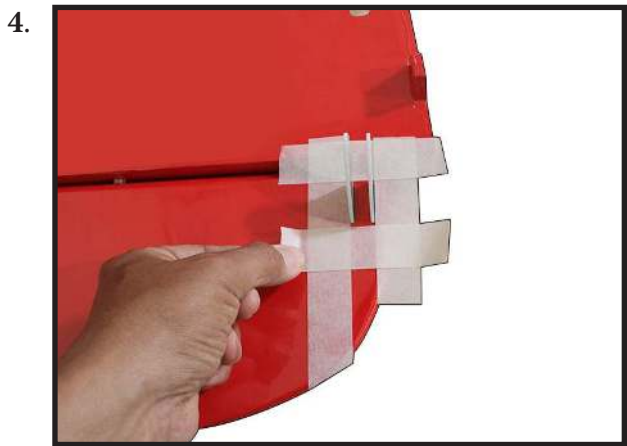
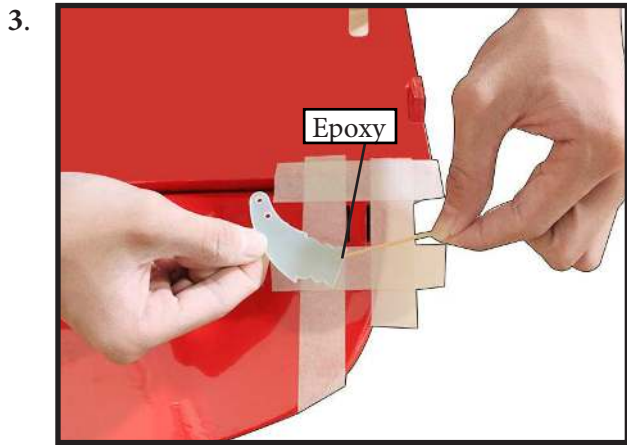
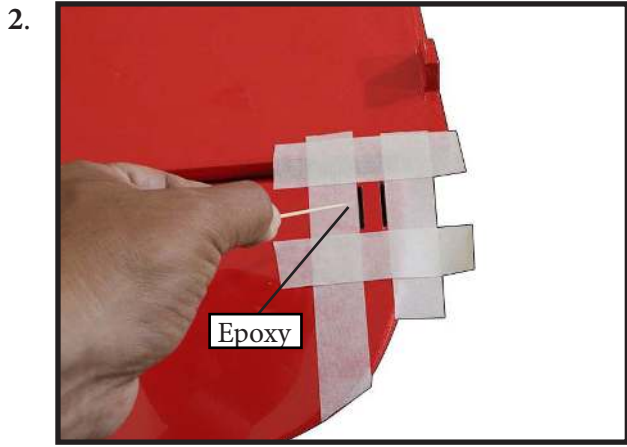

Install plastic ribs.

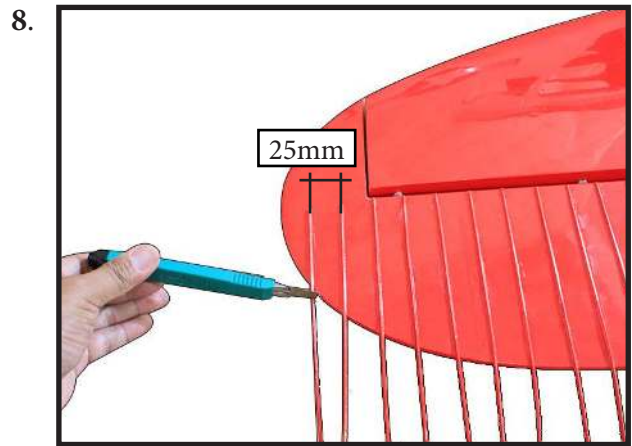
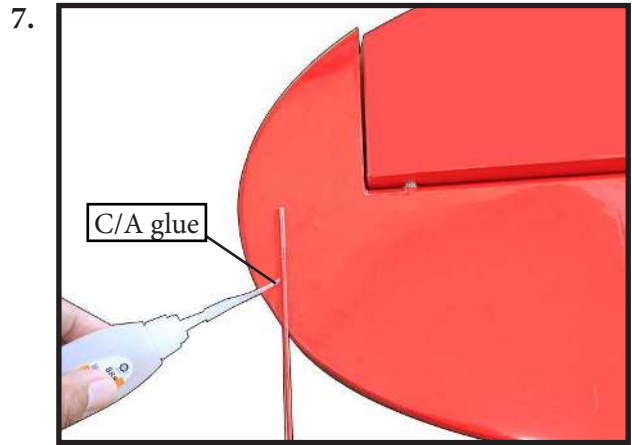
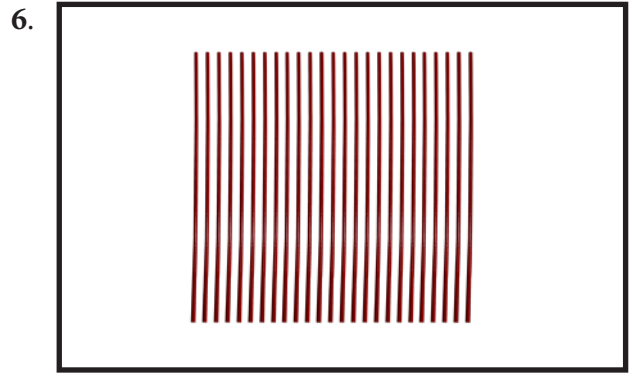

ELEVATOR SERVO INSTALLATION

The elevators have been pre-hinged and glued to the stabs and are ready for flight. No other steps are necessary for hinging.

NOTE : servos arm for elevator is not provided from manufacturer.

1.



Minimum servo spec.

Torque : 27.3 kg-cm (378 oz-in) @6.0V
33.7 kg-cm (467 oz-in) @7.4V
38.2 kg-cm (530 oz-in) @8.4V
Transit Speed : 0.14 sec/60° @6.0V
0.11 sec/60° @7.4V
0.10 sec/60° @8.4V

Attach the extension to the servo lead and secure with Safety Clip, safety wire, tape or other method. Ensure the plugs will not come apart from vibration or light tension.

Feed servo extension through the elevator servo mounting hole.

2.



Install servo with servo mounting screws.

3.

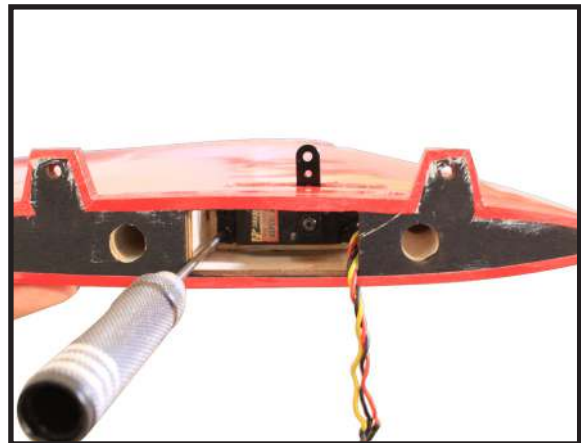

4.

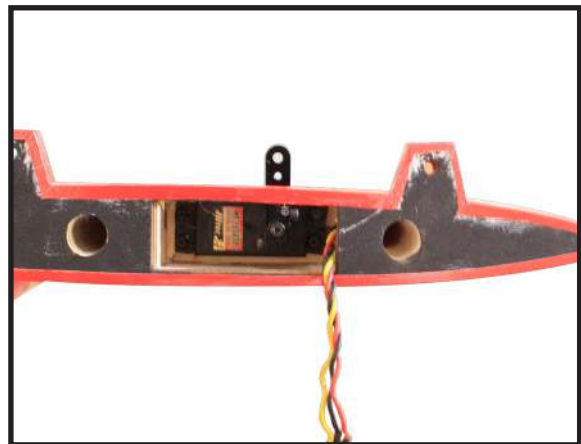

ELEVATOR PUSHROD INSTALLATION

Please study images below.

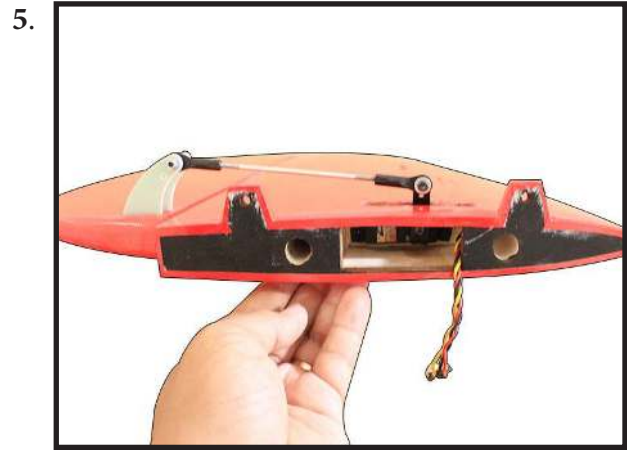
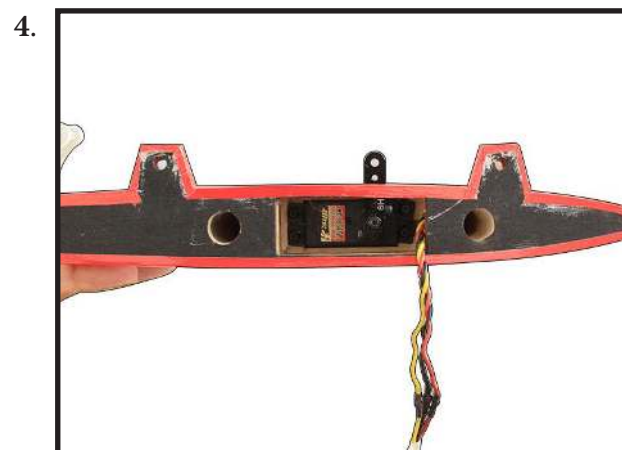
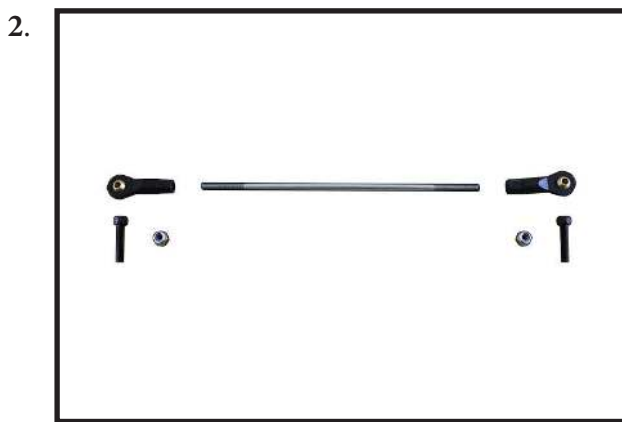
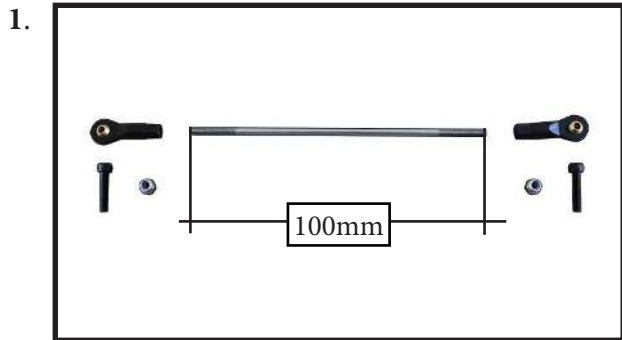

Repeat all the above steps for the other elevator.

INSTALL THE TAIL LIGHT BULB



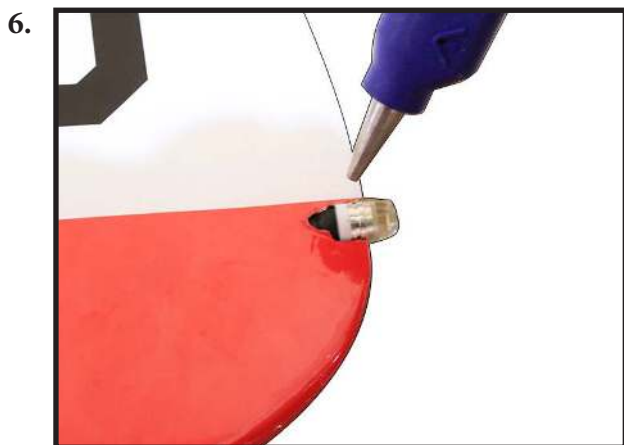
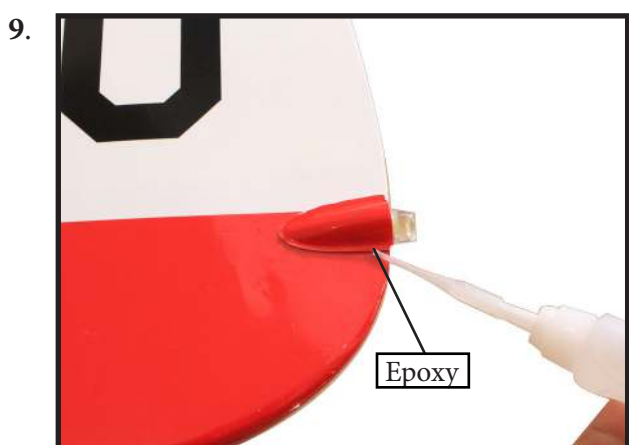
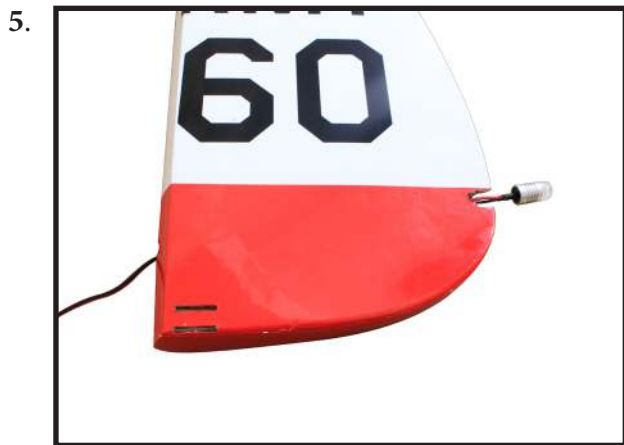
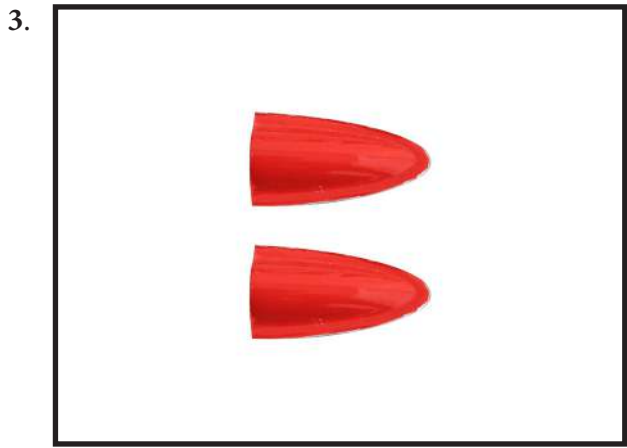

INSTALL NAIL HINGE RUDDER

Test fit the hinges into the rudder, and then the hinges into the tail. Ensure that the hinge pockets line up, and that the hinges move freely.

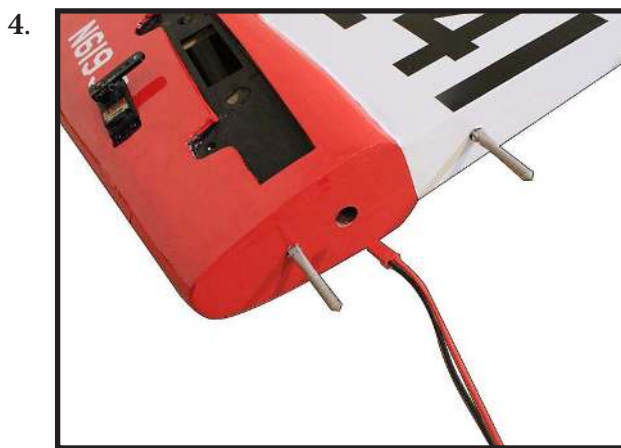
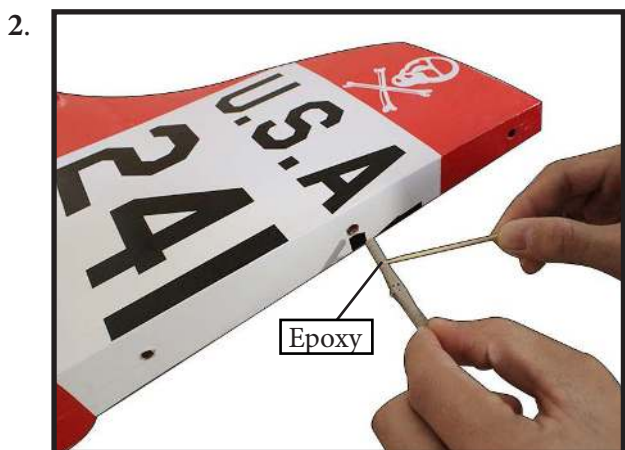

INSTALL RUDDER CONTROL HORN

Install the elevator control horn using the same method as same as the aileron control horns.

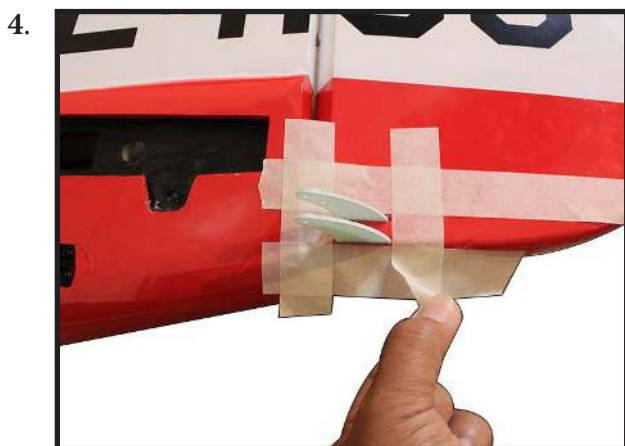
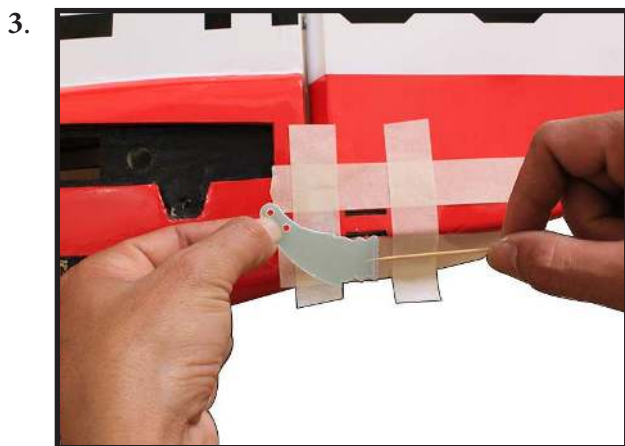
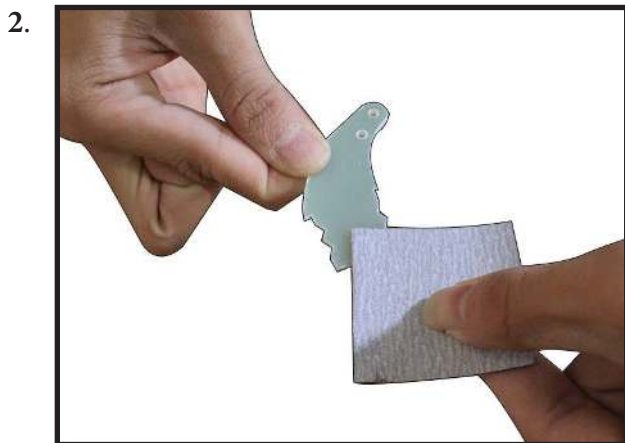
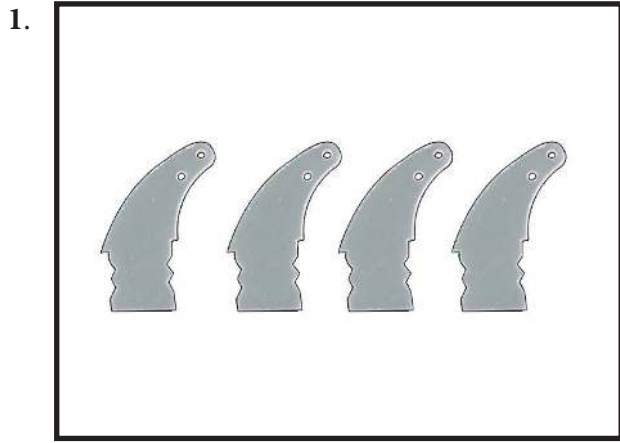

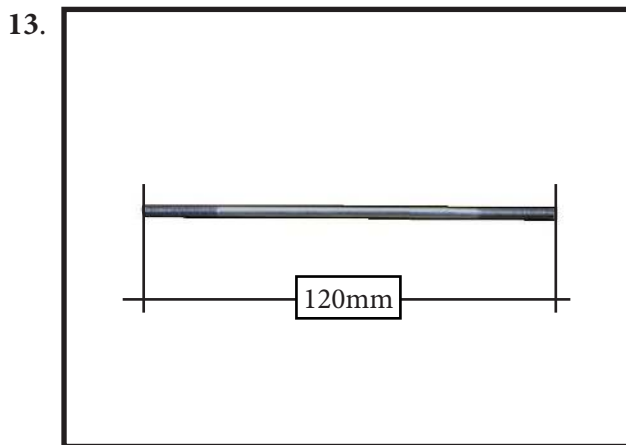

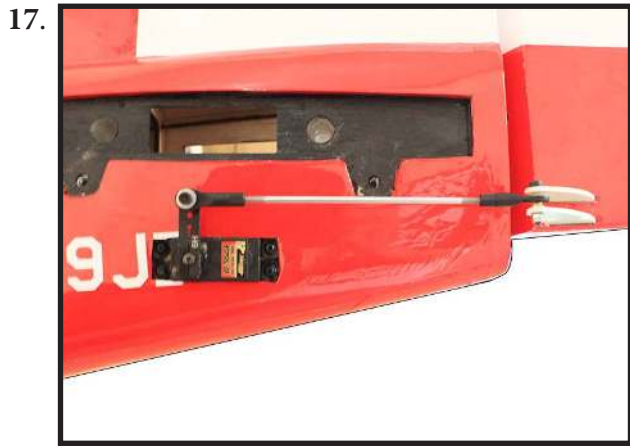

Install plastic ribs.

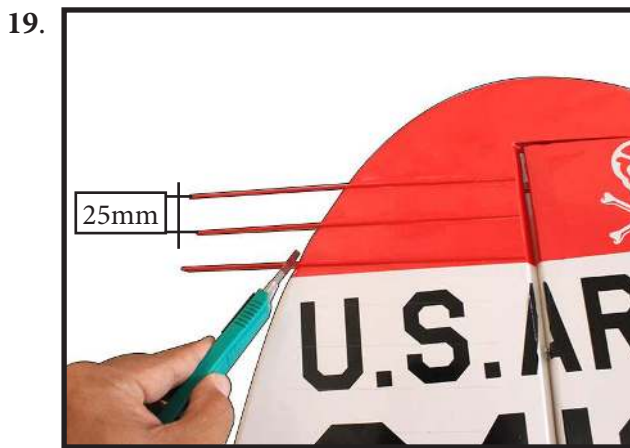
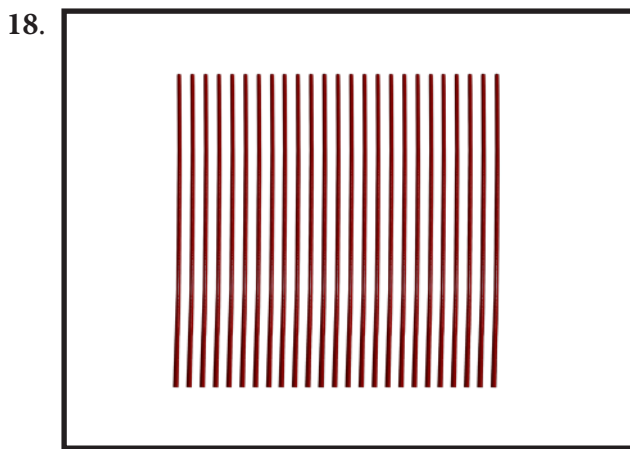

HORIZONTAL TAIL INSTALLATION

Please study images below.

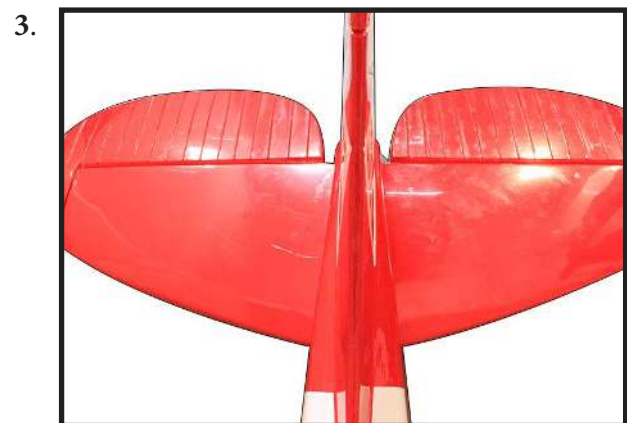
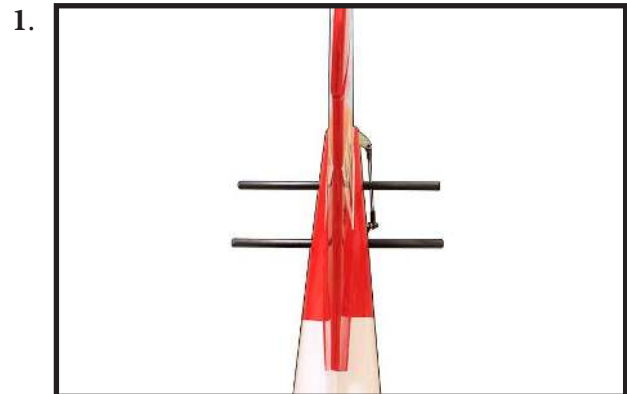

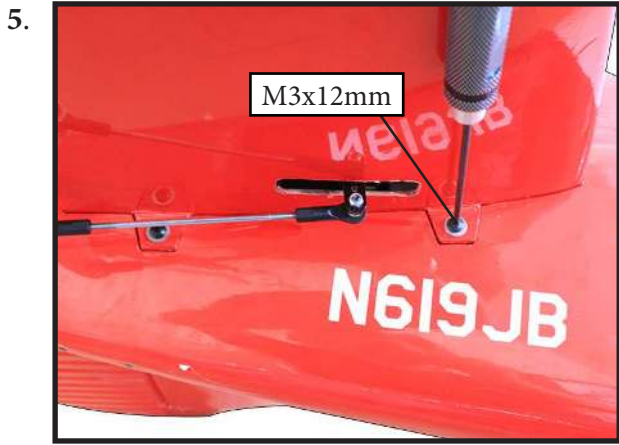

MOUNTING THE TAIL WHEEL

Locate items necessary to install tail wheel.

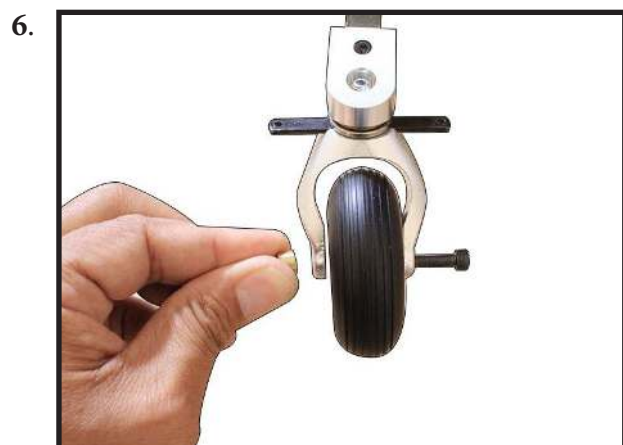
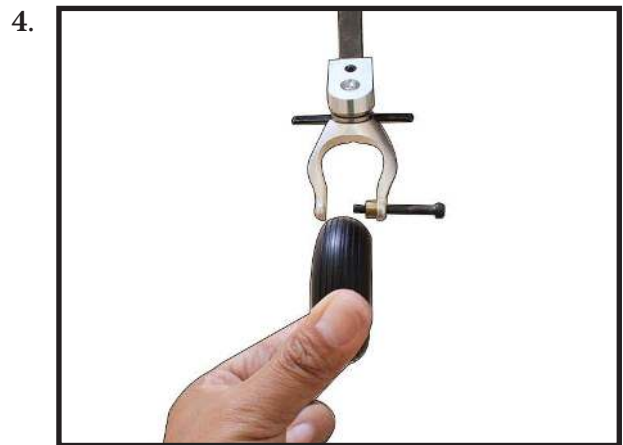
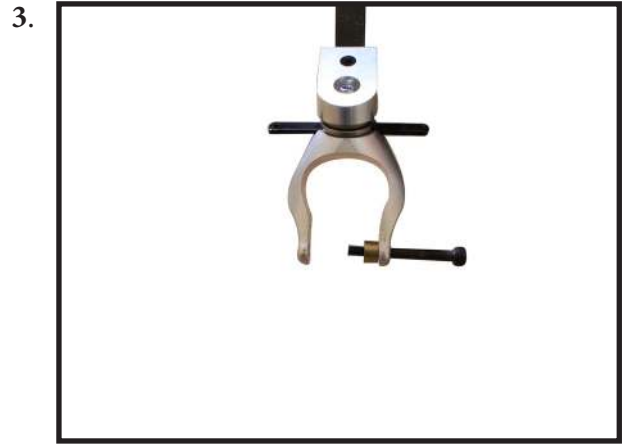
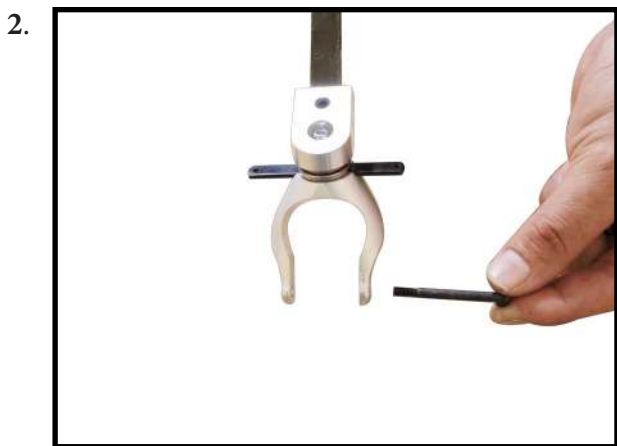
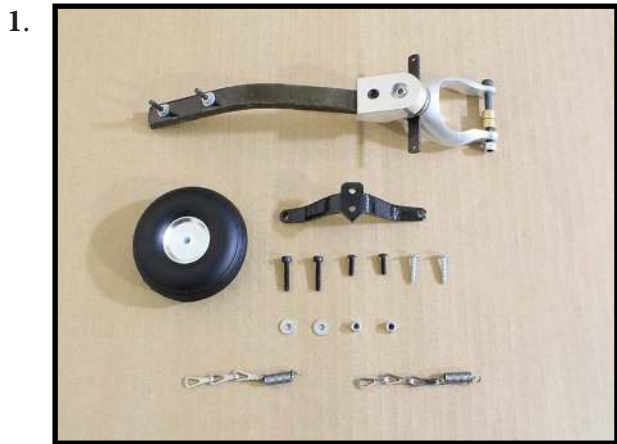





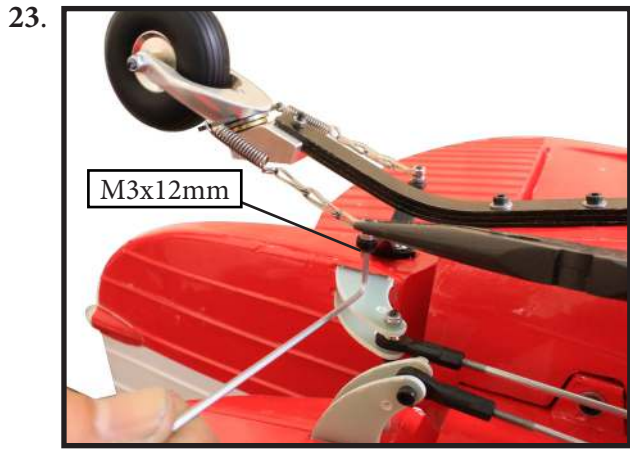

LANDING GEAR INSTALLATION

Locate items needed for landing gear installation.

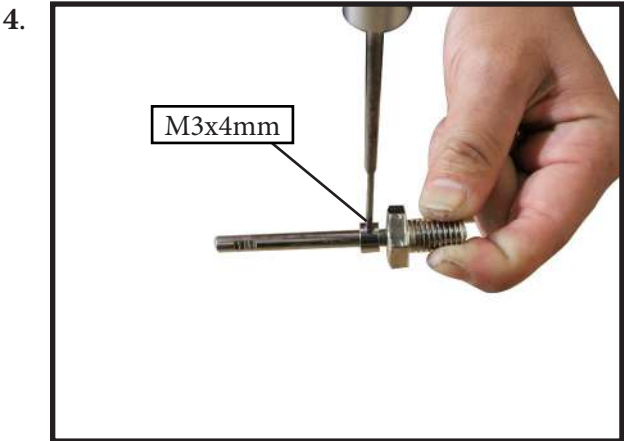

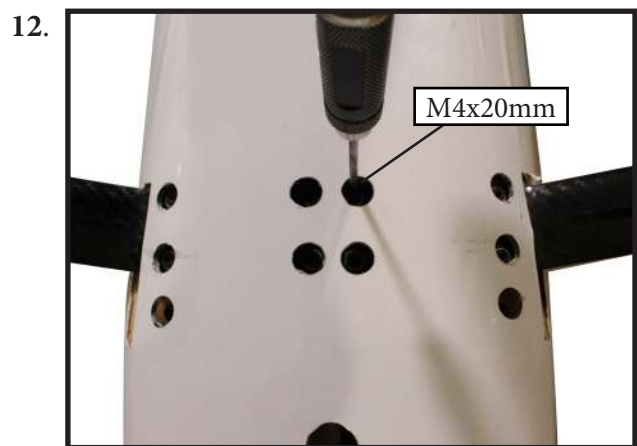
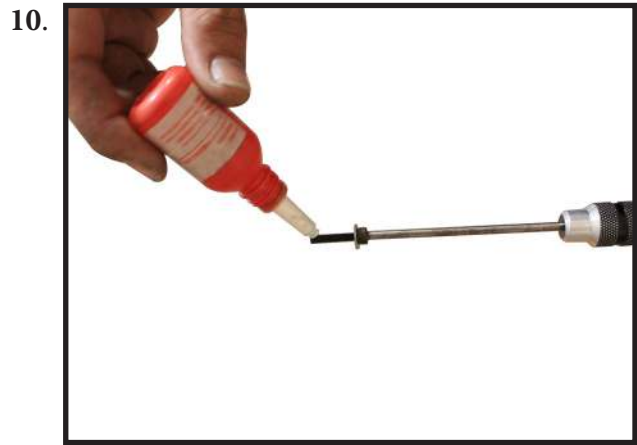



INSTALLING THE RECEIVER SWITCH

Install the switch into the pre-cut hole in the side, in the fuselage.

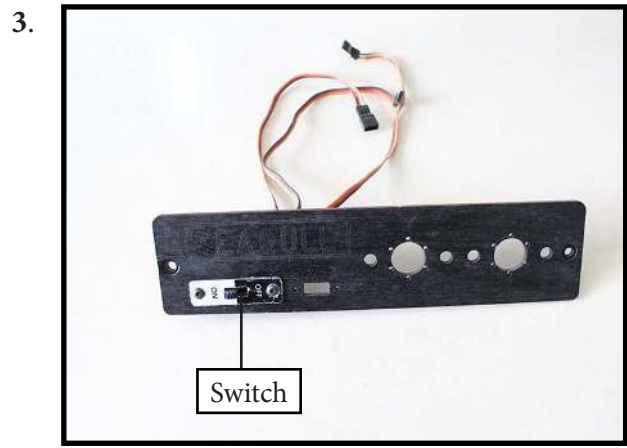
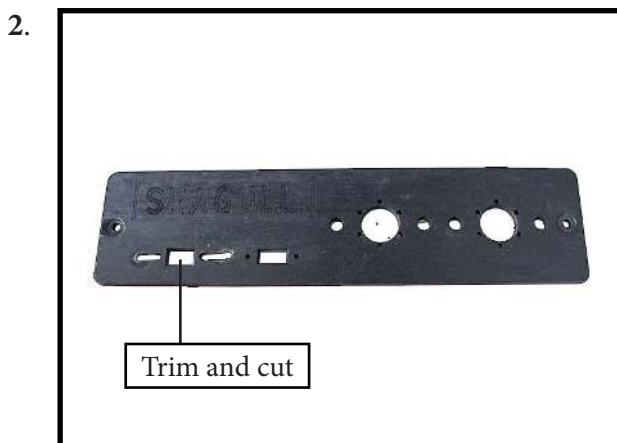
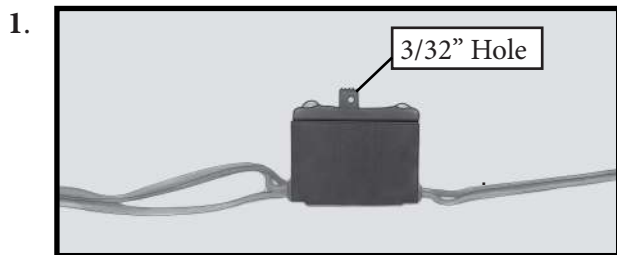

INSTALLING THE ENGINE SWITCH

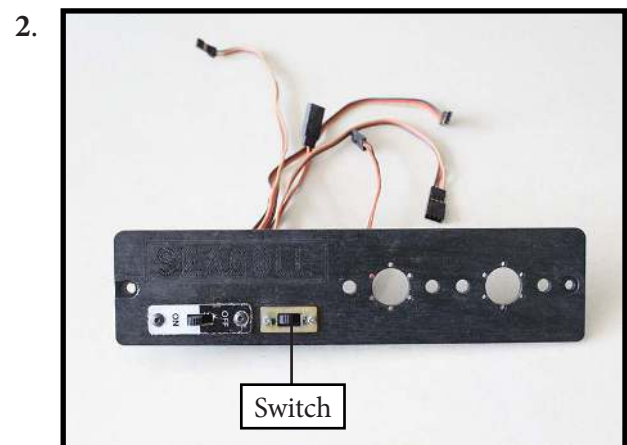
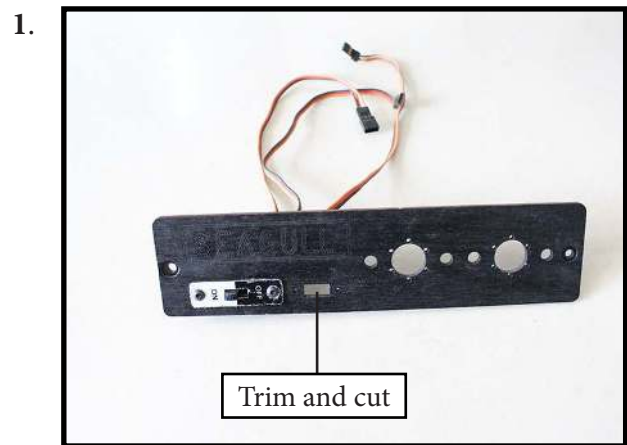

INSTALLING THE STOPPER ASSEMBLY

Using a modeling knife, carefully cut off the rear portion of one of the 3 nylon tubes leaving 1/2" protruding from the rear of the stopper. This will be the fuel pick up tube.

Using a modeling knife, cut one length of silicone fuel line. Connect one end of the line to the weighted fuel pick up and the other end to the nylon pick up tube.

1.



Carefully bend the second nylon tube up at a 45° angle. This tube is the vent tube.

Test fit the stopper assembly into the tank. It may be necessary to remove some of the flashing around the tank opening using a modeling knife. If flashing is present, make sure none falls into the tank.

With the stopper assembly in place, the weighted pick-up should rest away from the rear of the tank and move freely inside the tank. The top of the vent tube should rest just below the top of the tank. It should not touch the top of the tank.

When satisfied with the alignment of the stopper assembly tighten the 3 x 20mm machine screw until the rubber stopper expands and seals the tank opening. Do not over-tighten the assembly as this could cause the tank to split.

FUEL TANK INSTALLATION

1.



! *You should mark which tube is the vent and which is the fuel pickup when you attach fuel tubing to the tubes in the stopper. Once the tank is installed inside the fuselage, it may be difficult to determine which is which.*

2.



3.

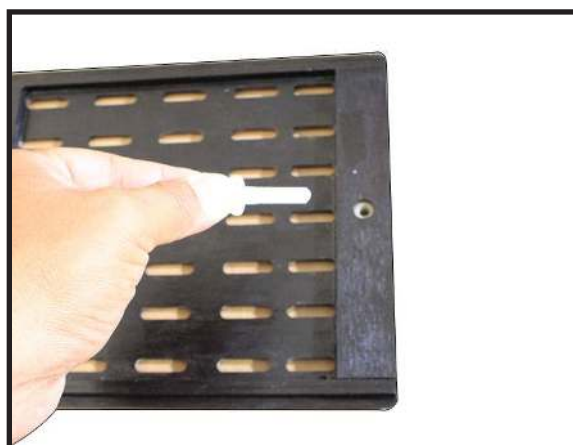

4.



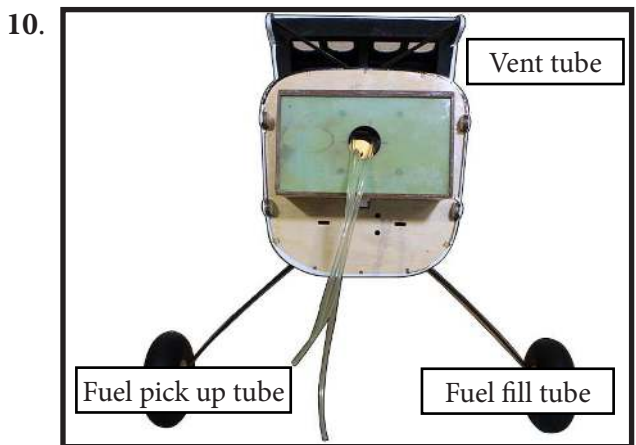

MOUNTING THE ENGINE

Please see below pictures.

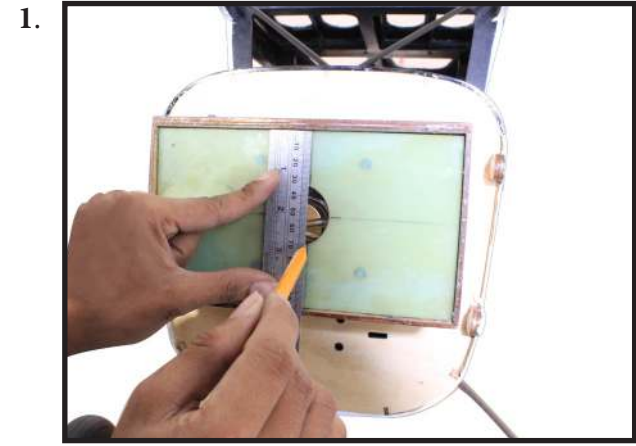
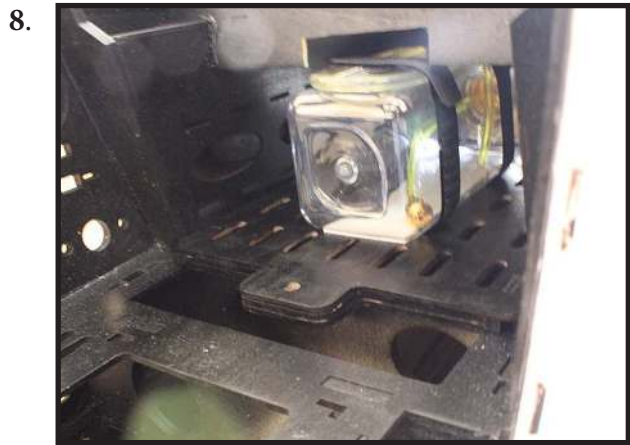

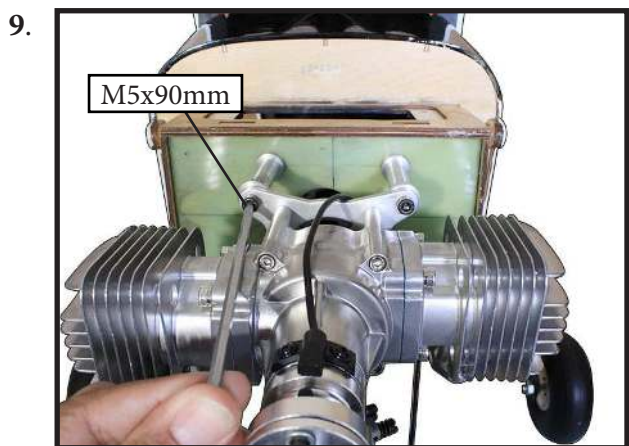
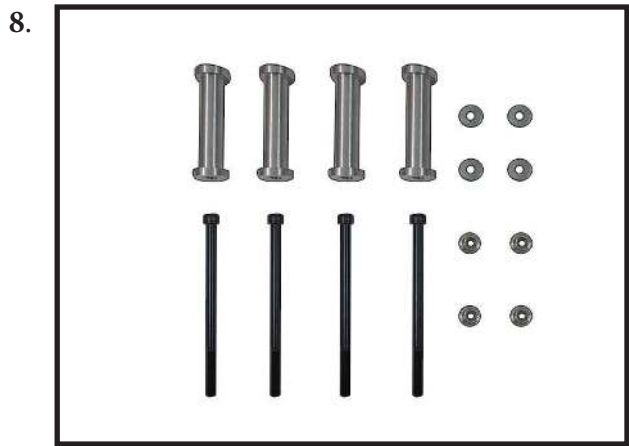
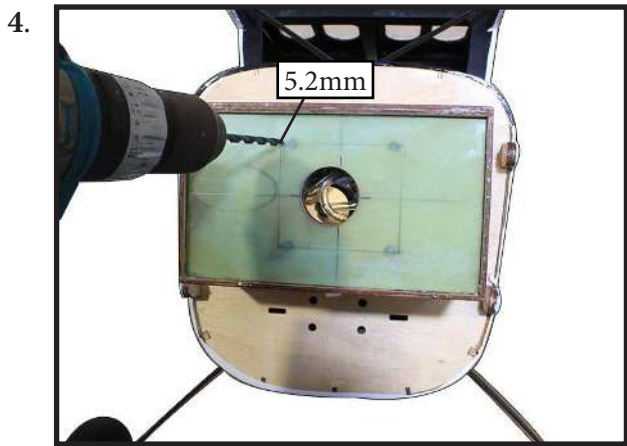
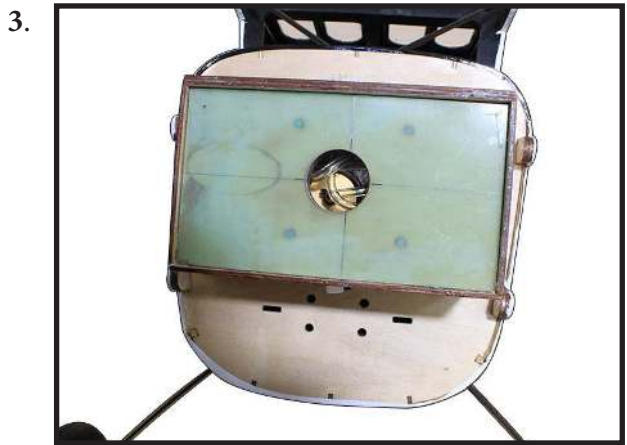
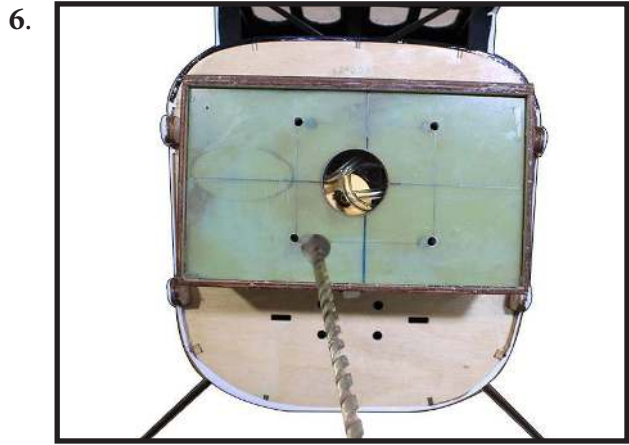
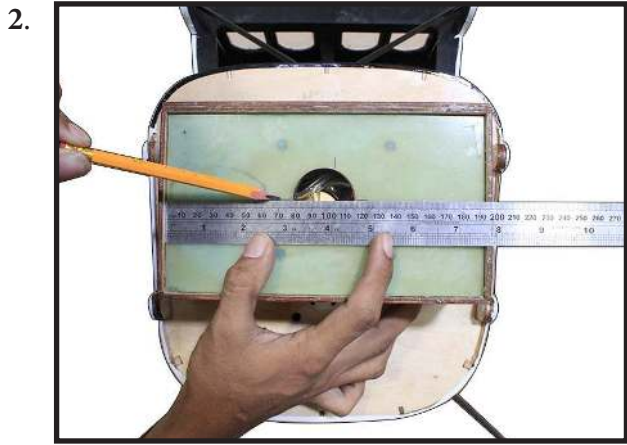

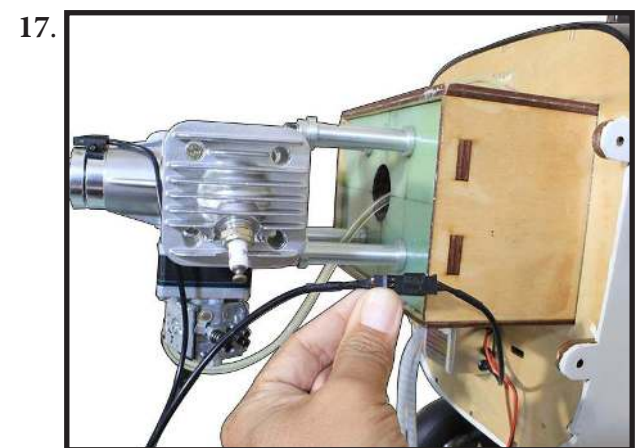
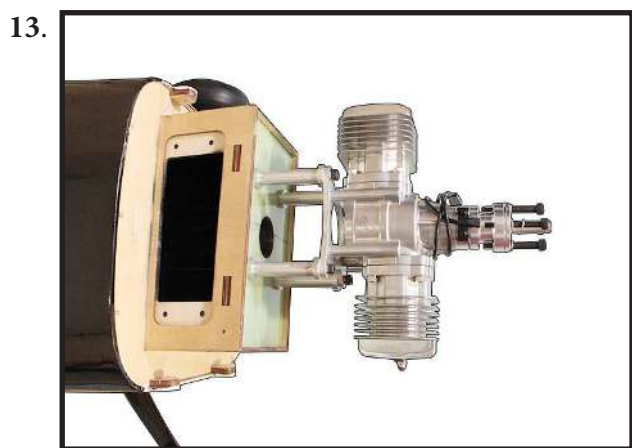
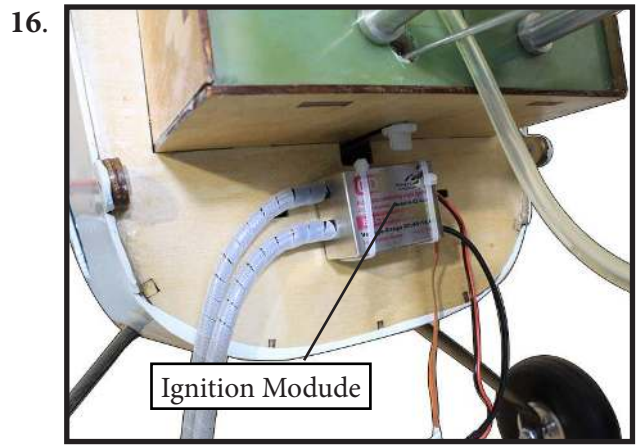
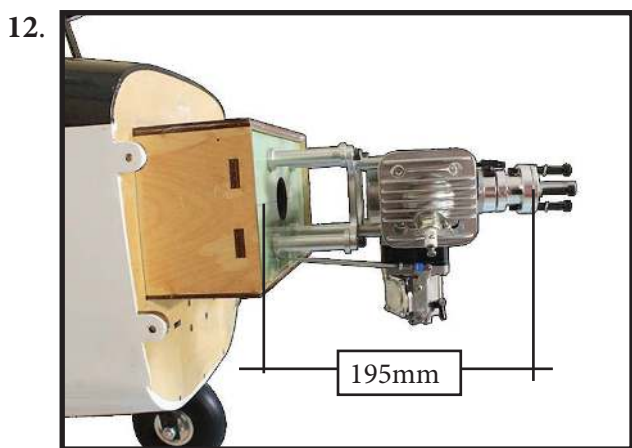
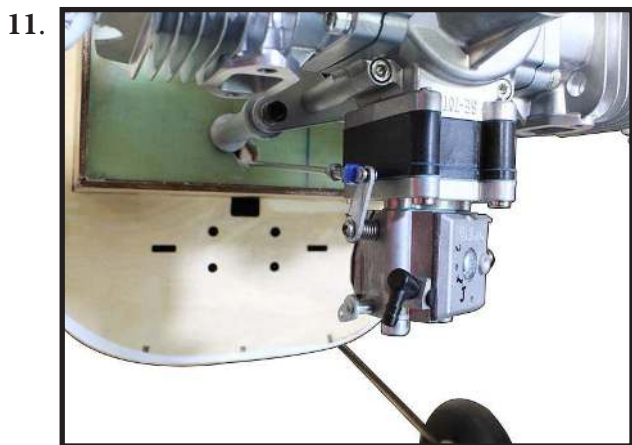
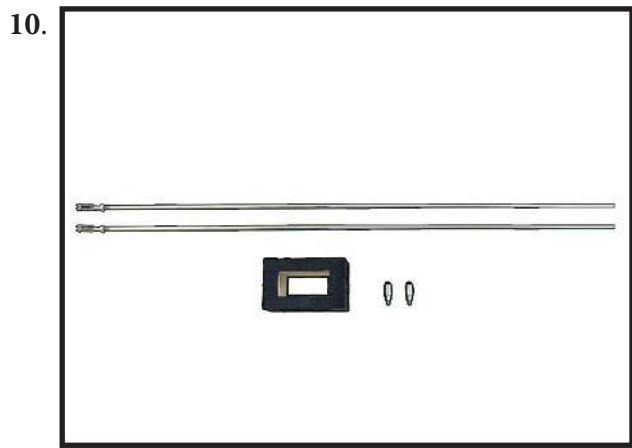

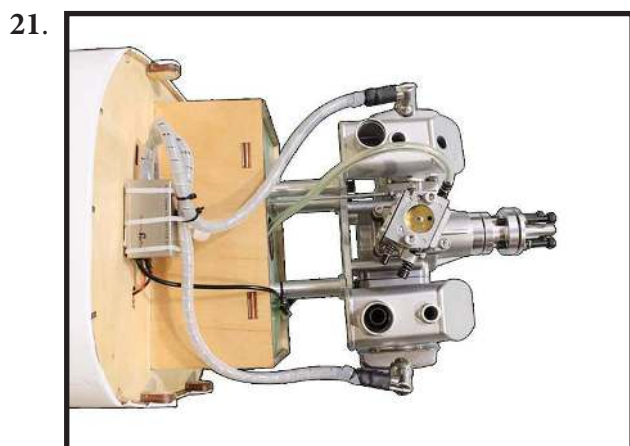
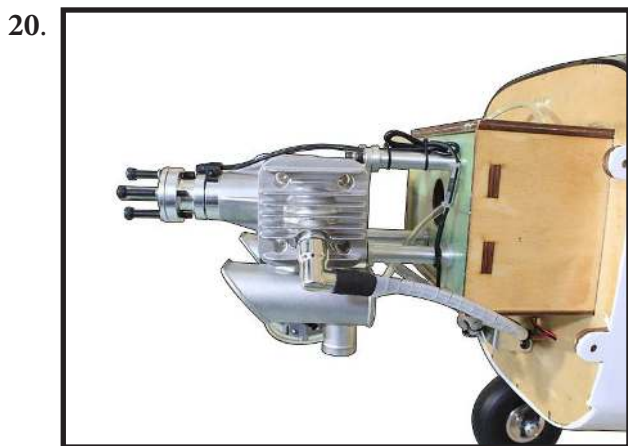
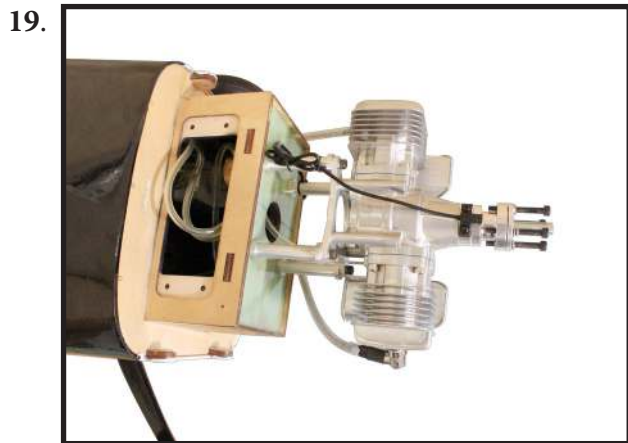
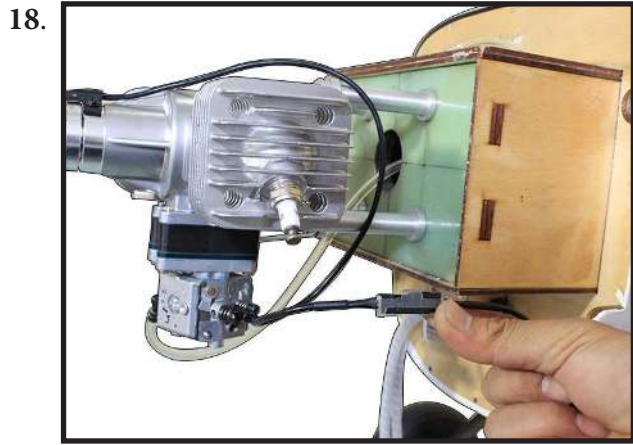

THROTTLE SERVO ARM INSTALLATION

Install adjustable servo connector in the servo arm as same as picture below:



Reinstall the servo horn by sliding the connector over the pushrod wire. Center the throttle stick and trim and install the servo horn perpendicular to the servo center line.

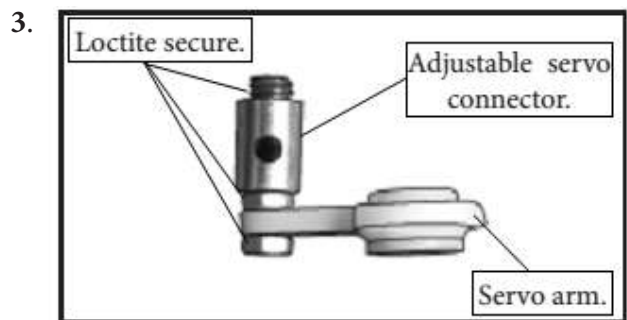

4.

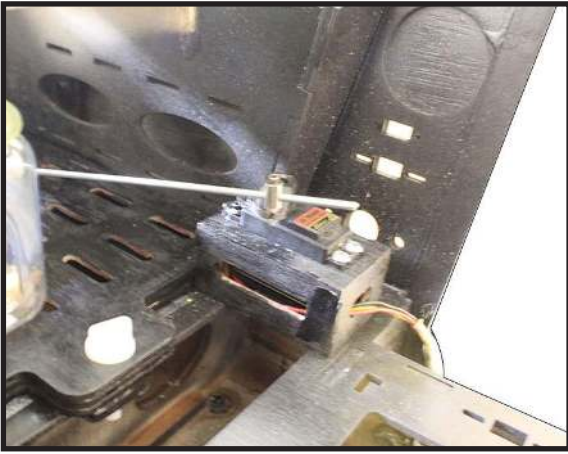

Move the throttle stick to the closed position and move the carburetor to closed. Use a 2.5mm hex wrench to tighten the screw that secures the throttle pushrod wire. Make sure to use threadlock on the screw so it does not vibrate loose.

5.

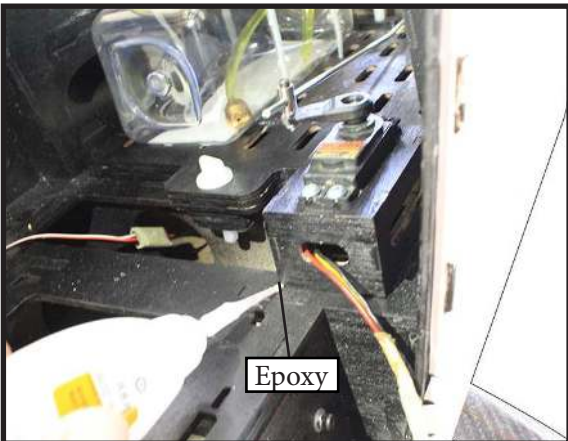

6.

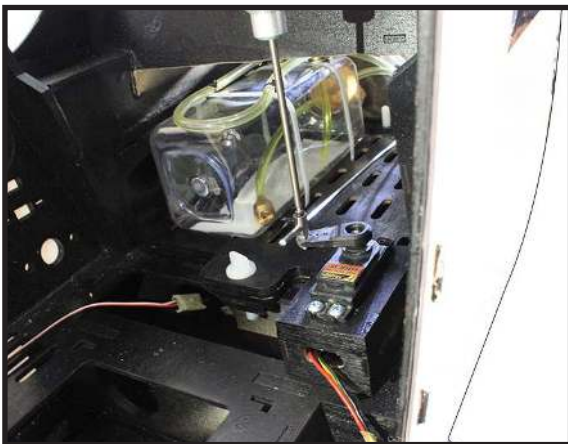

7.

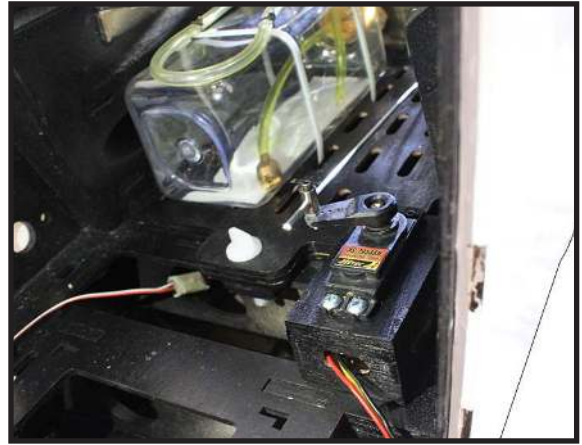

COWLING

Please see Images below:

1.



2.



Tape the cowl to the fuselage using low-tack tape.

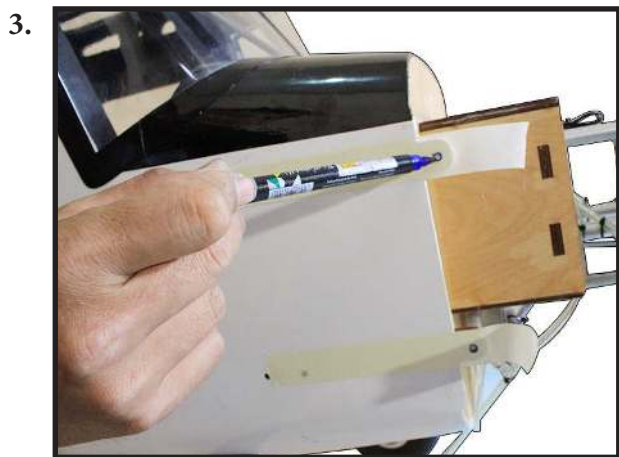

Use a drill and drill bit to drill the holes for the cowl mounting screws. Make sure the cowl position is correct before drilling each hole.

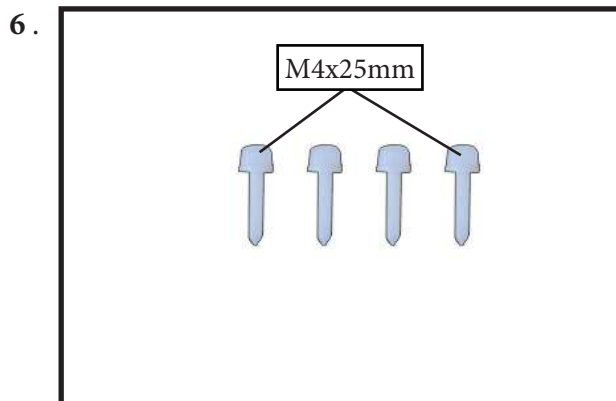
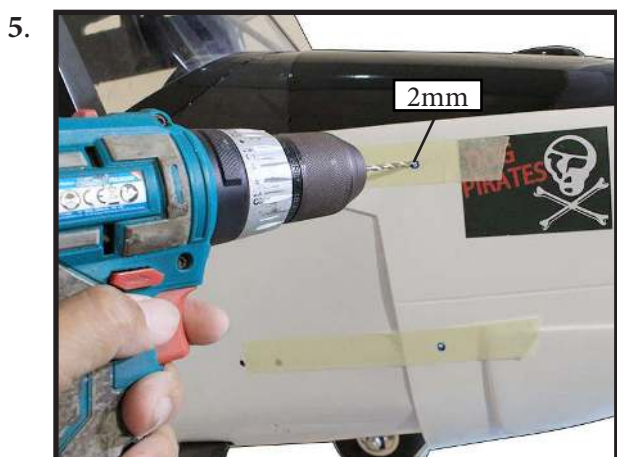

Because of the size of the cowl, it may be necessary to use a needle valve extension for the high speed needle valve. Make this out of sufficient length 1.5mm wire and install it into the end of the needle valve. Secure the wire in place by tightening the set screw in the side of the needle valve.

INSTALLING THE SPINNER

Install the spinner backplate, propeller and spinner cone.



⚠ The propeller should not touch any part of the spinner cone. If it does, carefully trim spinner cone opening until propeller no longer comes in contact with it.

2.



INSTALL LED BULB ON BODY BELLY

Parts requirement. See pictures below.

1.



2.

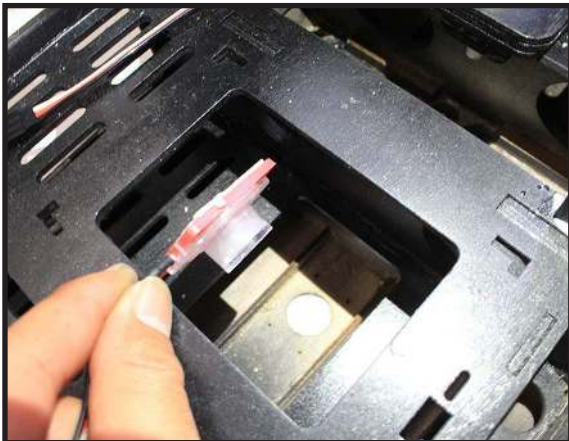

3.

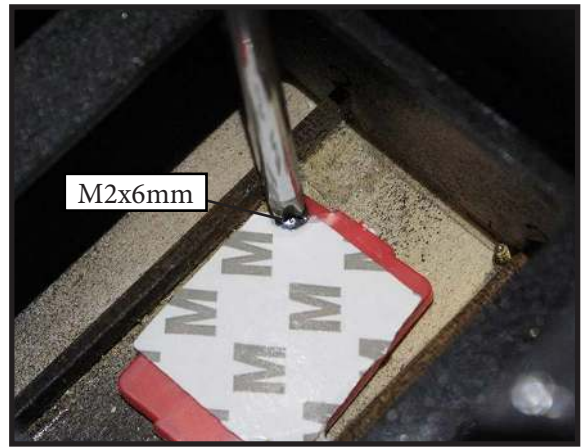

4.



INSTALL THE WINDOW

Parts requirement. See pictures below.

1.



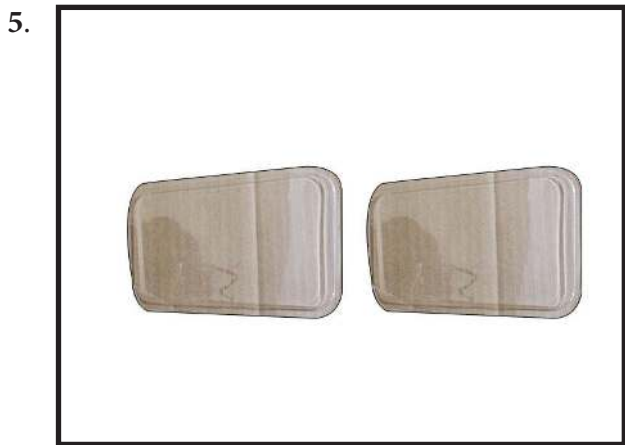
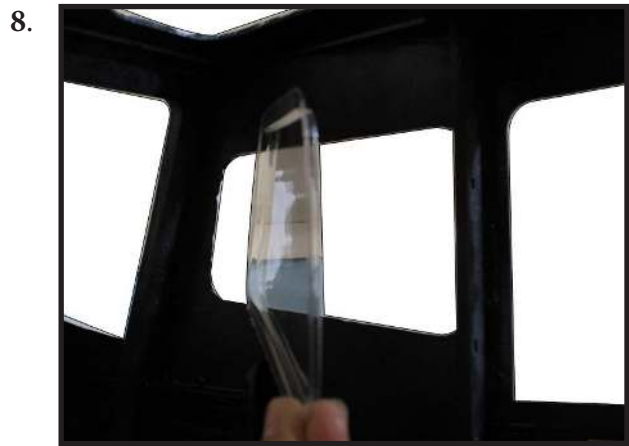
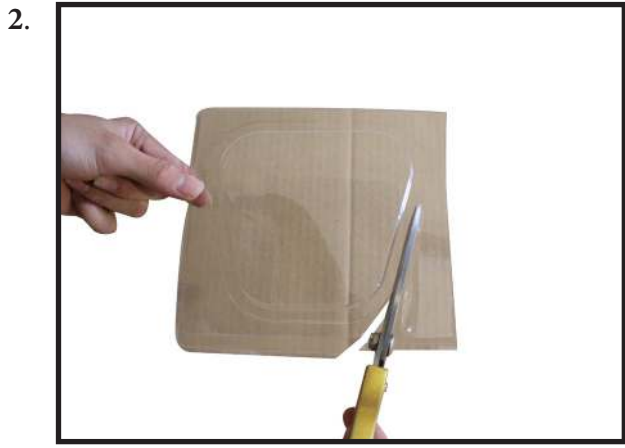

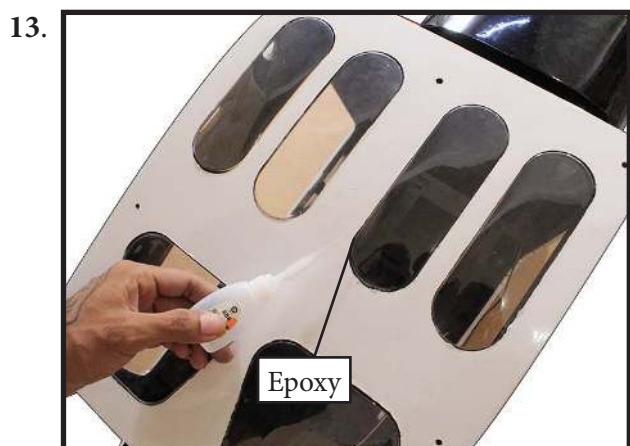
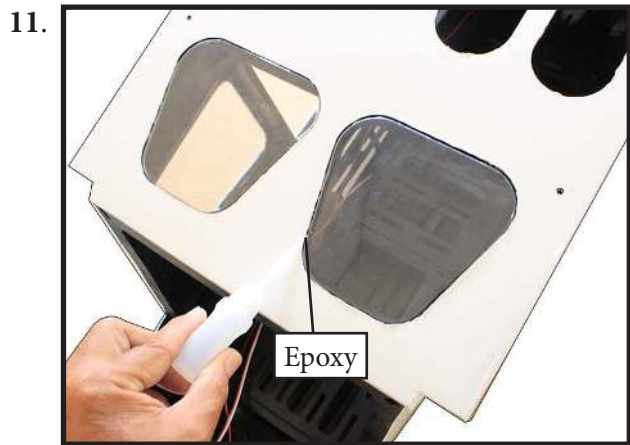
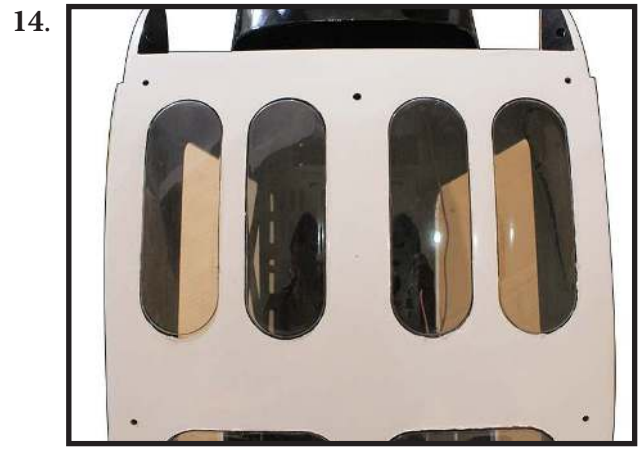

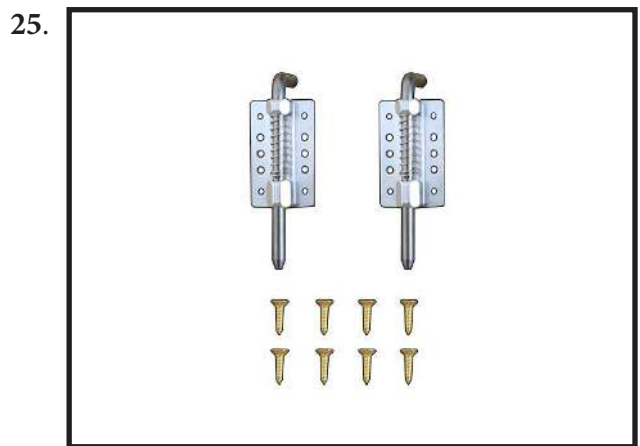
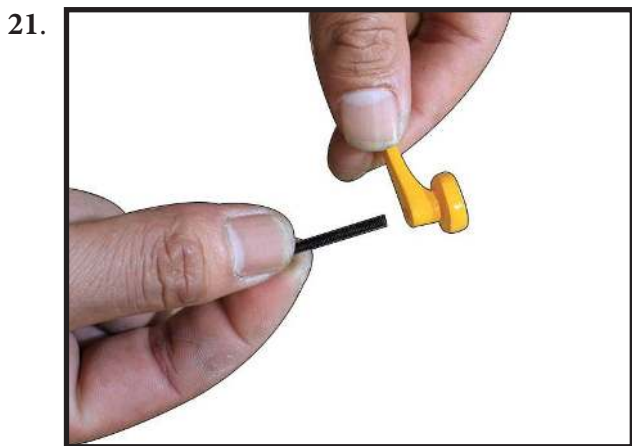
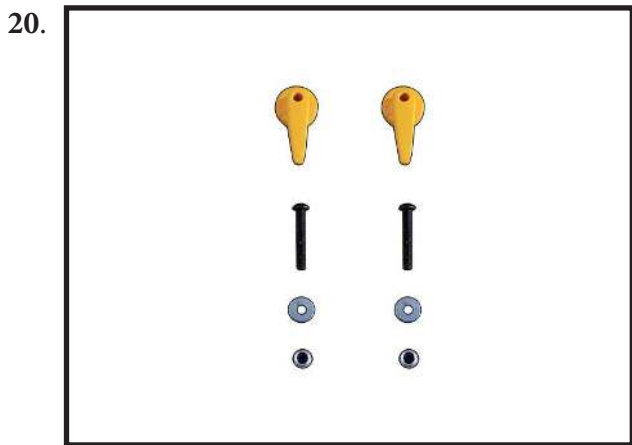
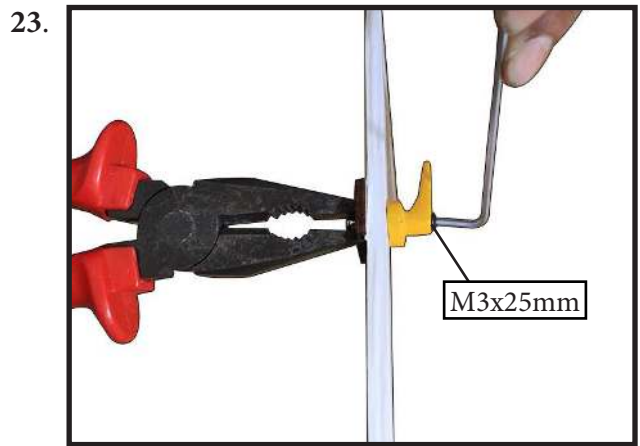
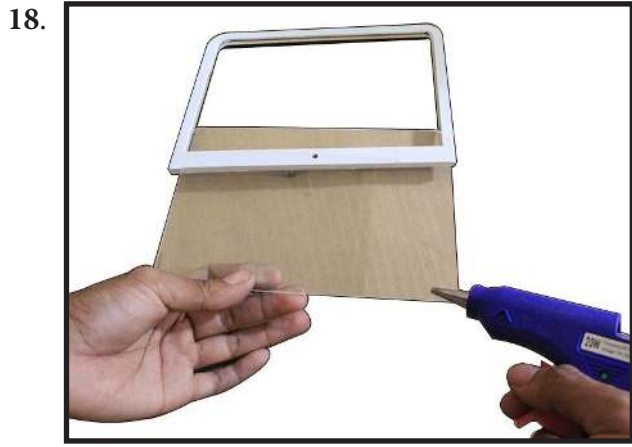

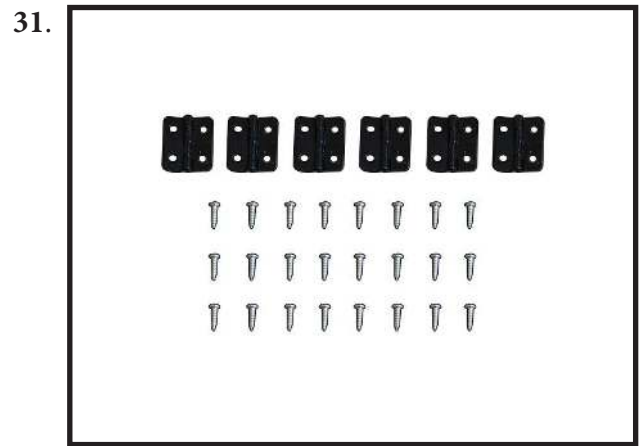
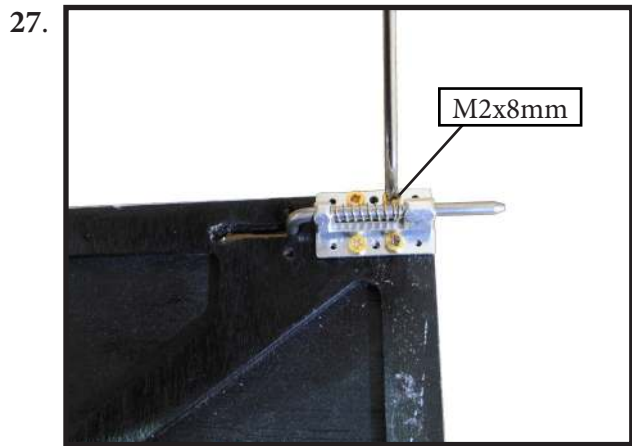
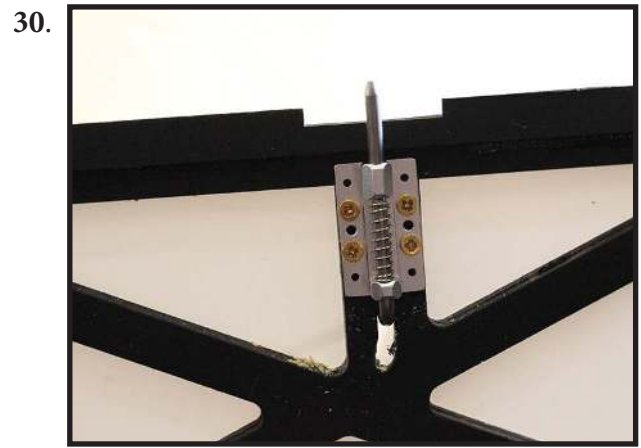

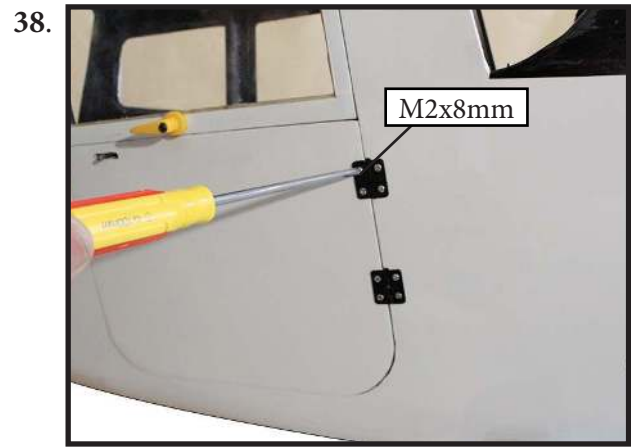
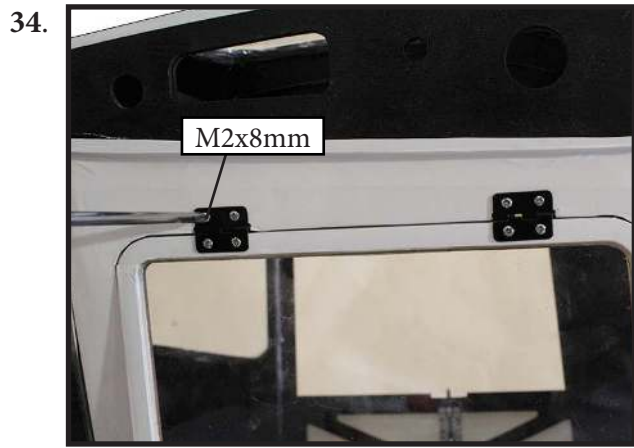

INSTALLATION COCKPIT AND CANOPY

Locate items necessary to install.



2.

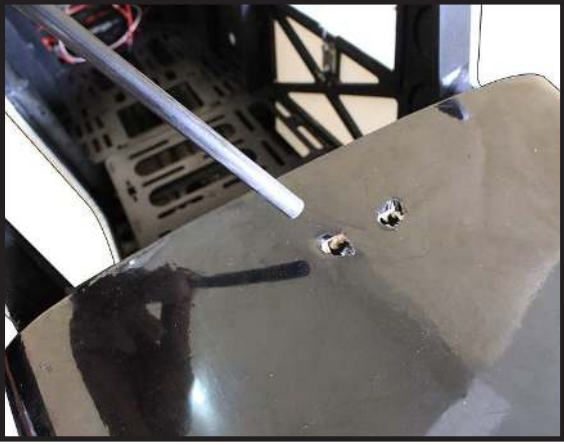

6.

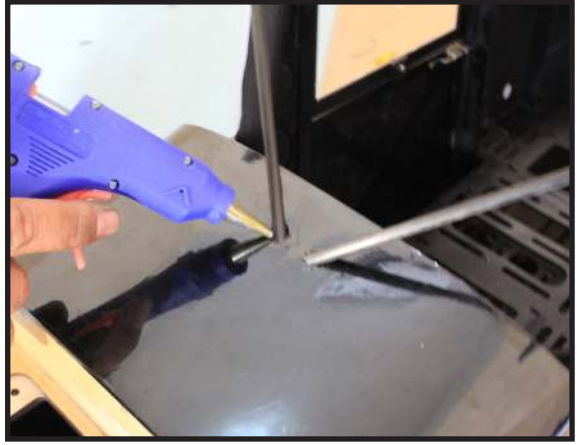

3.

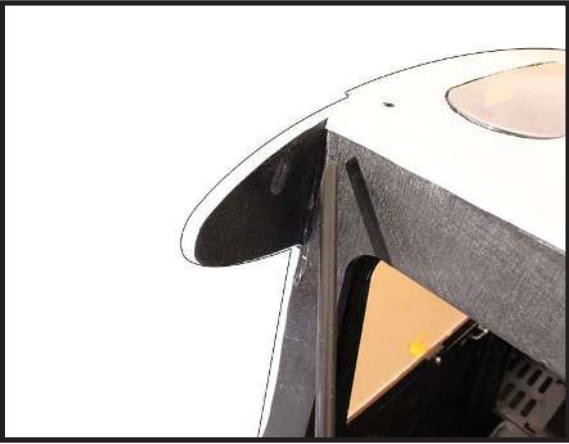

7.

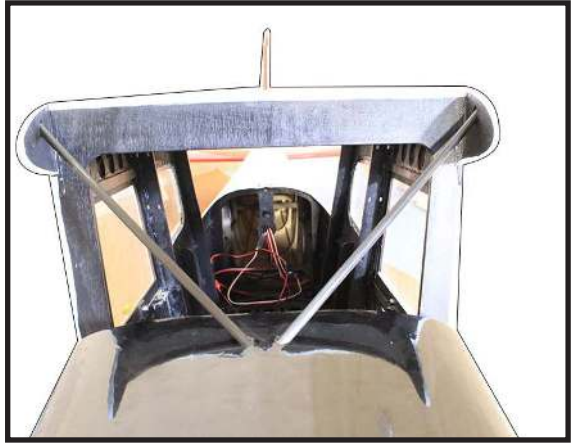

4.

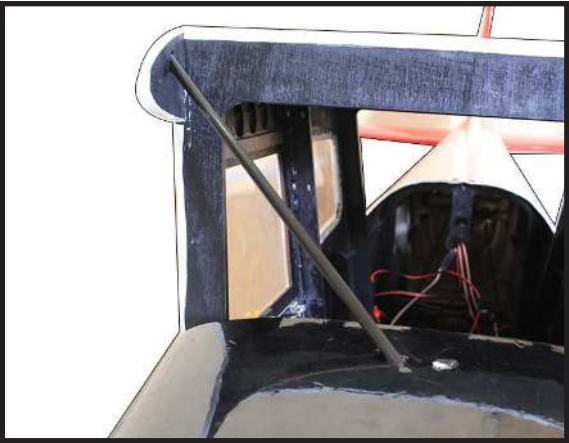

8.

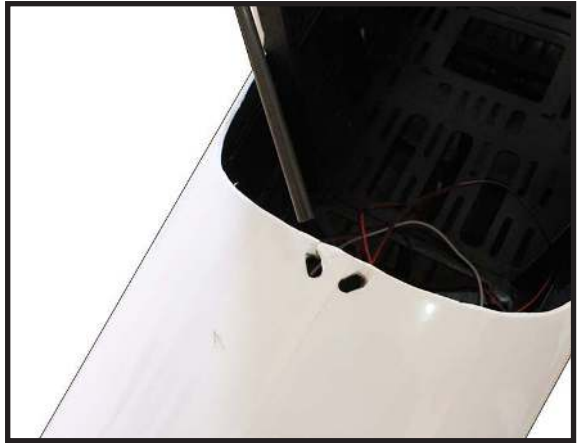

5.



9.



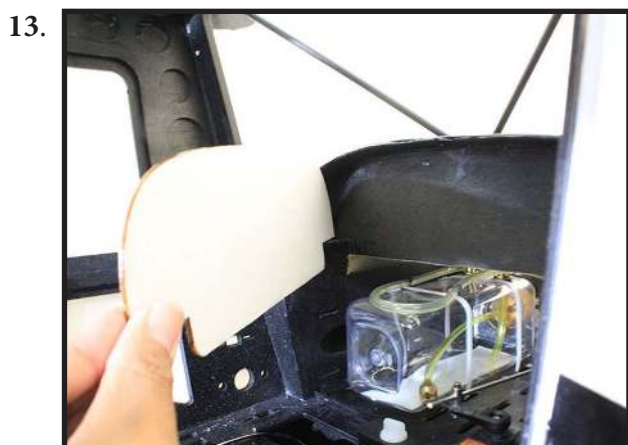

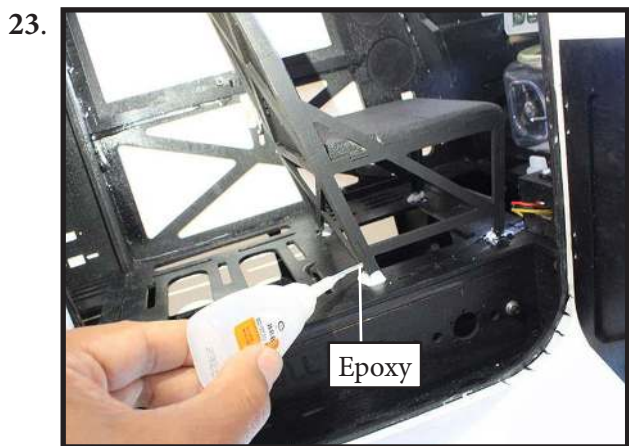

INSTALLING BATTERY - RECEIVER

Plug the servos leads and the switch lead into the receiver. Plug the battery pack lead into the switch also.

Wrap the receiver and battery pack in the protective foam rubber to protect them from vibration.

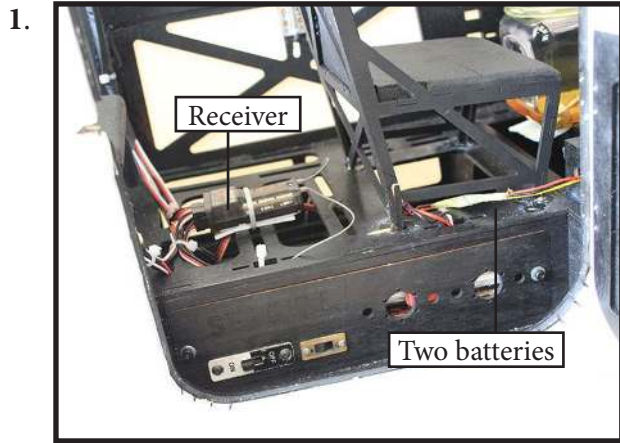

ATTACHMENT WING- FUSELAGE

Parts requirement. See pictures below.

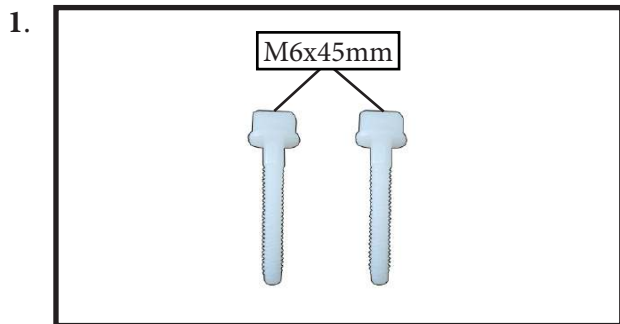

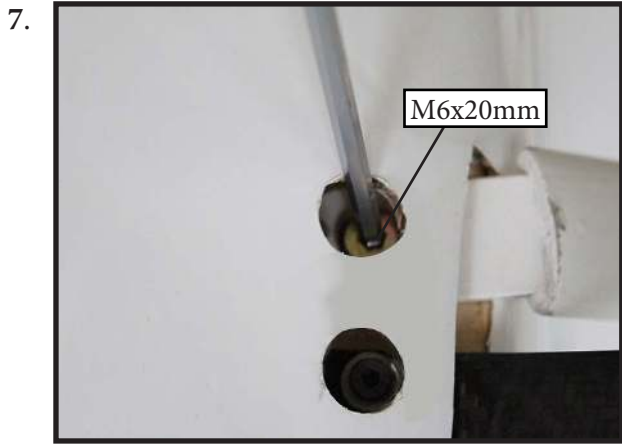

ANTENNA INSTALLATION

Parts requirement. See pictures below.

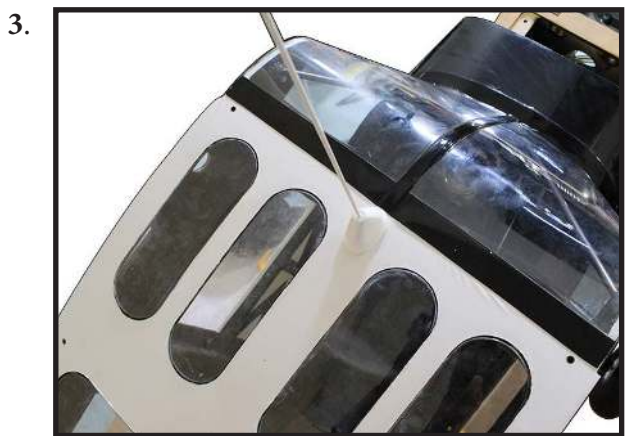
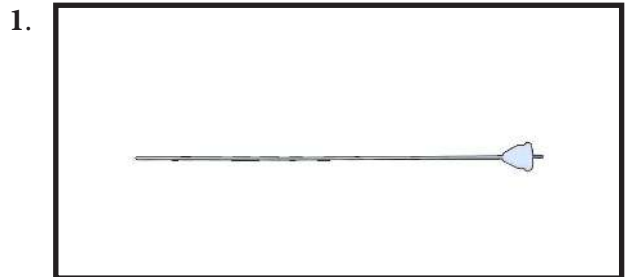



INSTALL FUEL CAP

Parts requirement. See pictures below.

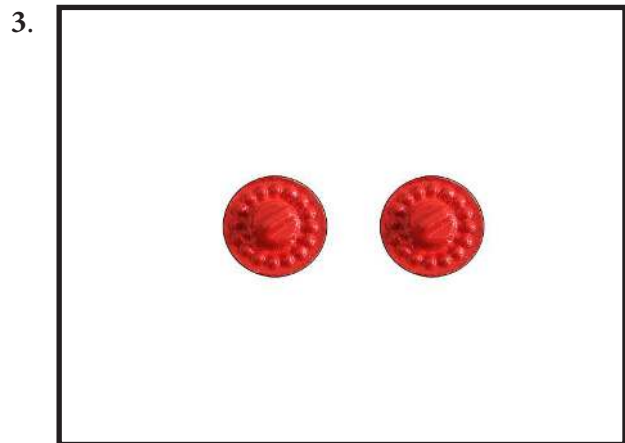
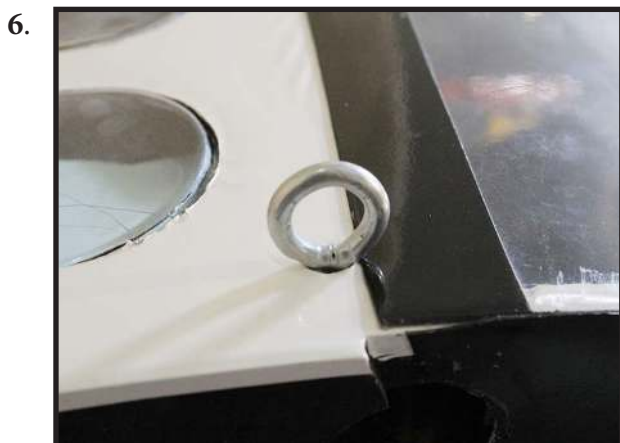
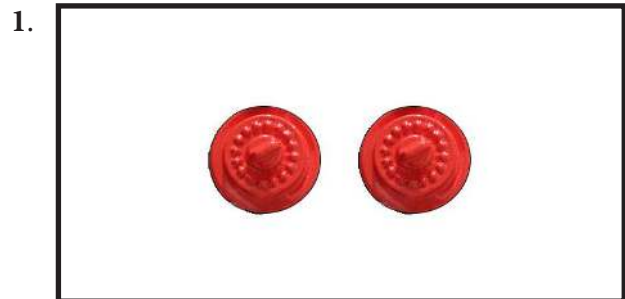

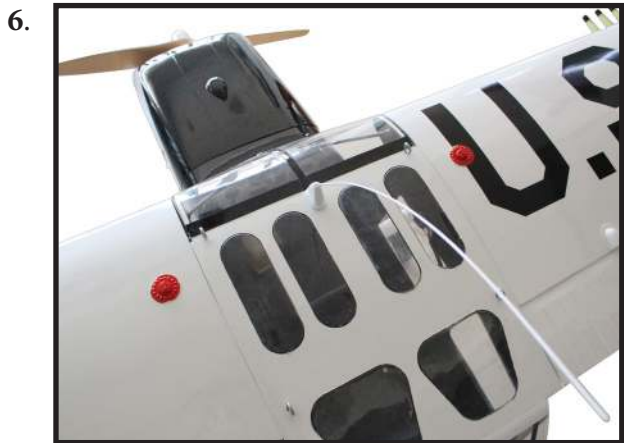
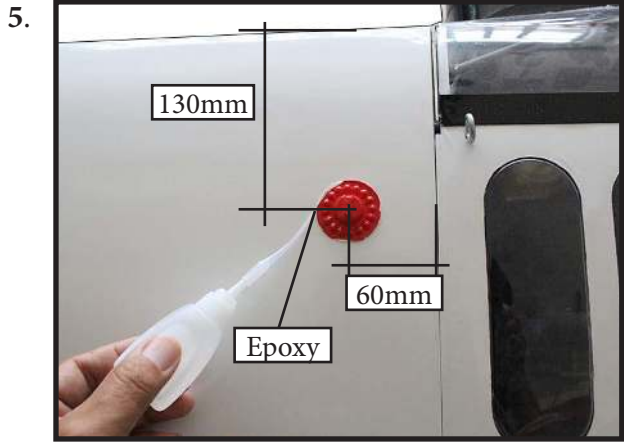



APPLY THE DECALS

If all the decals are precut and ready to stick. Please be certain the model is clean and free from oily fingerprints and dust. Position decal on the model where desired, using the photos on the box and aid in their location.

If all the decals are not precut, please use scissors or a sharp hobby knife to cut the decals from the sheet. Please be certain the model is clean and free from oily fingerprints and dust. Position decal on the model where desired, using the photos on the box and aid in their location.

BALANCING

An important part of preparing the aircraft for flight is properly balancing the model.

1) Attach the wing panels to the fuselage. Make sure to connect the leads from the aileron to the appropriate leads from the receiver. Make sure the leads are not exposed outside the fuselage before tightening the wing bolts. Your model should be flight-ready before balancing.

2) The recommended Center of Gravity (CG) location for your model is (120mm) back from the leading edge at the center of the wing.

3) When balancing your model, make sure it is assembled and ready for flight. Support the plane upright at the marks made on the wing with your fingers or a commercially available balancing stand. This is the correct balance point for your model.

*If possible, first attempt to balance the model by changing the position of the receiver battery and receiver. If you are unable to obtain good balance by doing so, then it will be necessary to add weight to the nose or tail to achieve the proper balance point.

With the wings attached to the fuselage, all parts of the model installed (ready to fly), and empty fuel tanks, hold the model at the marked balance point with the stabilizer level.

Lift the model. If the tail drops when you lift, the model is "tail heavy" and you must add weight* to the nose. If the nose drops, it is "nose heavy" and you must add weight* to the tail to balance.

1.

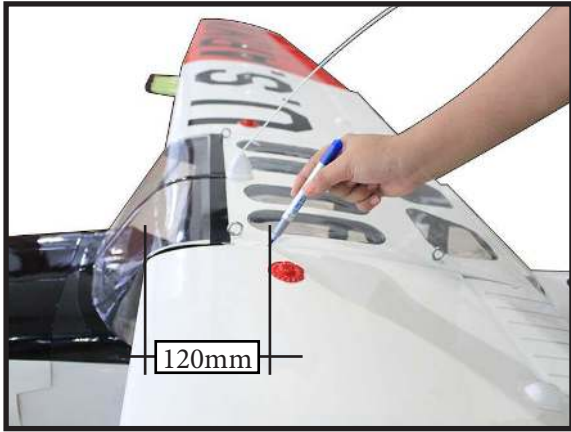

CONTROL THROWS

<p>Ailerons:</p> <p>High Rate : Up : 40mm Down : 40mm</p> <p>Low Rate : Up : 30mm Down : 30mm</p> <p>Elevator:</p> <p>High Rate : Up : 70mm Down : 70mm</p> <p>Low Rate : Up : 60mm Down : 60mm</p>	<p>Rudder:</p> <p>High Rate : Right : 70mm Left : 70mm</p> <p>Low Rate : Right : 60mm Left : 60mm</p> <p>Flap:</p> <p>Mid : 50mm Full : 100mm</p>
---	--

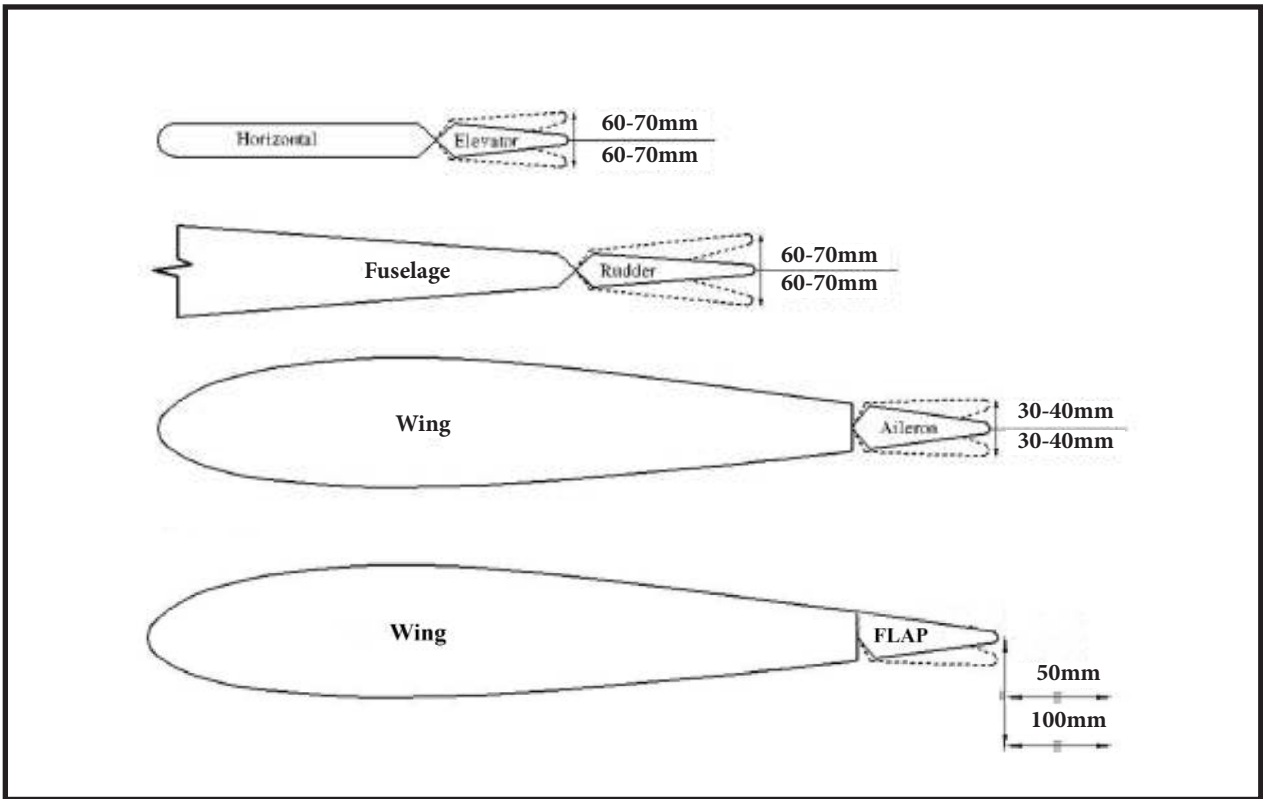

FLIGHT PREPARATION

Check the operation and direction of the elevator, rudder, ailerons and throttle.

□ A) Plug in your radio system per the manufacturer's instructions and turn everything on.

□ B) Check the elevator first. Pull back on the elevator stick. The elevator halves should move up. If it they do not, flip the servo reversing switch on your transmitter to change the direction.

□ C) Check the rudder. Looking from behind the airplane, move the rudder stick to the right. The rudder should move to the right. If it does not, flip the servo reversing switch on your transmitter to change the direction.

□ D) Check the throttle. Moving the throttle stick forward should open the carburetor barrel. If it does not, flip the servo reversing switch on your transmitter to change the direction.

□ E) From behind the airplane, look at the aileron on the right wing half. Move the aileron stick to the right. The right aileron should move up and the other aileron should move down. If it does not, flip the servo reversing switch on your transmitter to change the direction.

PREFLIGHT CHECK

□ 1) Completely charge your transmitter and receiver batteries before your first day of flying.

□ 2) Check every bolt and every glue joint in the **Giant Scale Cessna O-1 Bird Dog 122" ARF 70-125cc** to ensure that everything is tight and well bonded.

□ 3) Double check the balance of the airplane. Do this with the fuel tank empty.

□ 4) Check the control surfaces. All should move in the correct direction and not bind in any way.

□ 5) If your radio transmitter is equipped with dual rate switches double check that they are on the low rate setting for your first few flights.

□ 6) Check to ensure the control surfaces are moving the proper amount for both low and high rate settings.

□ 7) Check the receiver antenna. It should be fully extended and not coiled up inside the fuselage.

□ 8) Properly balance the propeller. An out of balance propeller will cause excessive vibration which could lead to engine and/or airframe failure.

We wish you many safe and enjoyable flights with your
Giant Scale Cessna O-1 Bird Dog 122" ARF 70-125cc.

*If you have any queries, or are interested in our products,
please feel free to contact us*

Factory : 12/101A - Hamlet 4 - Le Van Khuong Street - Dong Thanh Ward -
Hoc Mon District - Ho Chi Minh City - Viet Nam.

Office : 62/8 Ngo Tat To Street - Ward 19 - Binh Thanh District - Ho Chi Minh
City - Viet Nam

Phone : 848 - 86622289 or 848- 36018777

Website : www.SeagullModels.com

Email : Sales@seagullmodels.com

Facebook : www.facebook.com/SeaGullModels.