

VOLANTEX RC



F16 Falcon
USER MANUAL

V. 11.2021

WARNING

The following terms are used throughout the product literature to indicate various levels of potential harm when operating this product.

CAUTION: Procedures, which if not be properly followed, is able to create a possibility of physical property damage AND or possibility of injury.

 Read the **ENTIRE** instruction manual to become familiar with the features of the product before operating. Fail to operate the product correctly can result in damage to the product, personal property and cause serious injury.

 This is a sophisticated hobby product and **NOT a toy**. It must be operated with caution and common sense and requires some basic mechanical ability. Fail to operate this Product in a safe and responsible manner could result in injury or damage to the product or other property. This product is not intended for use by children without direct adult supervision. Do not attempt to disassemble, use with incompatible components or augment product in any way without the approval of VolantexRC Co., Ltd.. This manual contains instructions for safety, operation and maintenance. It is essential to read and follow all the instructions and warnings in the manual, prior to assembly, setup or use, in order to operate correctly and avoid damage or serious injury. Age Recommendation: Not for children under 14 years. This is not a toy.

Safety Precautions

As the user of this product, you are solely responsible for operating in a manner that does not endanger yourself and others or result in damage to the product or the property of others.

- Always ensure all batteries have been properly charged before using the vehicle.
- Always check all servos and their connections prior to each run.
- Never operate your vehicle near spectators, parking areas or any other area that could result in injury to people or damage of property.
- Never operate your vehicle during adverse weather conditions. Poor visibility can cause disorientation and loss of control of your vehicle.
- Never point the transmitter antenna directly toward the vehicle. The radiation pattern from the tip of the antenna is inherently low.
- If at any time during the operation of your vehicle you observe any erratic or abnormal operation, immediately stop operation of your vehicle until the cause of the problem has been ascertained and corrected.

Battery Usage & Charging Warnings

CAUTION: All instructions and warnings must be followed exactly. Mishandling of Li-Po/Li-Ion/Ni-Mh batteries can result in fire, personal injury, and/or property damage.

- The battery charger included with your plane(if there be) is designed to safely balance and charge the specific Li-Po/Li-Ion/Ni-Mh battery.

- By handling, charging or using the included battery, you shall assume all risks associated with Li-Po/Li-Ion/Ni-Mh battery.
- If at any time the battery begins to balloon or swell, discontinue use immediately. If charging or discharging, you should discontinue and disconnect.
- Continue to use, charge or discharge a battery that is ballooning or swelling can result in fire.
- Always store the battery at room temperature in a dry area for best results.
- Always transport or temporarily store the battery in a temperature range of 40-120 Fahrenheit degrees (5-49 degrees centigrade). Do not store battery or your plane in a car or direct sunlight. If stored in a hot car, the battery can be damaged or even cause fire.
- Always charge a battery away from flammable materials.
- Always inspect the battery before charging and never charge damaged batteries.
- Always disconnect the battery after charging, and allow the charger cool before next charge.
- Always constantly monitor the temperature of the battery pack while charging.
- ONLY USE A CHARGER SPECIALLY DESIGNED TO CHARGE SPECIFIC BATTERIES.
- Never discharge Li-Po cells till below 3V under load.
- Never cover warning labels with hook or loop strips.
- Never leave charging batteries unattended.
- Never charge batteries outside recommended levels.
- Never attempt to dismantle or alter the charger.
- Never allow minors to charge battery packs.
- Never charge batteries in extremely hot or cold places (recommended between 40-120 Fahrenheit degrees / 5-49 degrees centigrade) or in direct sunlight.

Box Contents

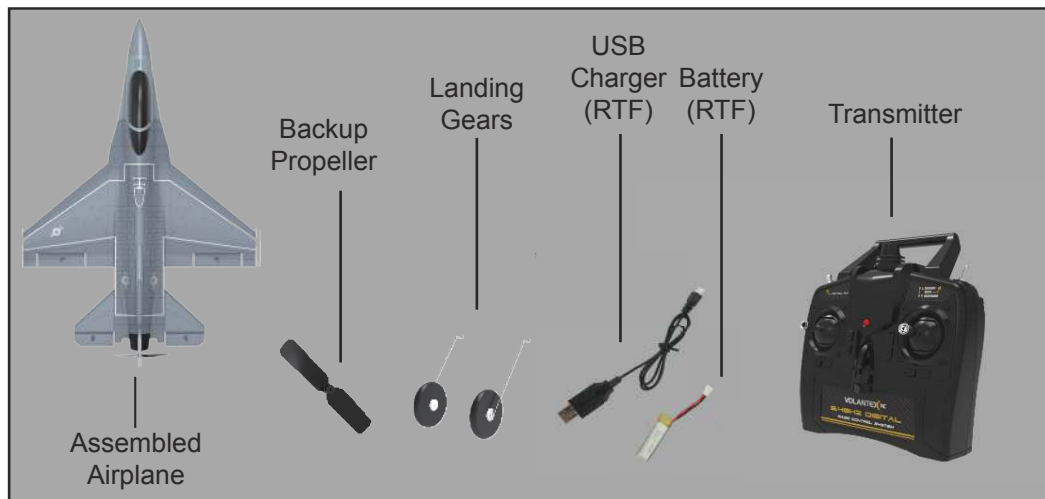

NOTE: The actual product may vary slightly from manual according to the model you purchased.

Charging Instruction

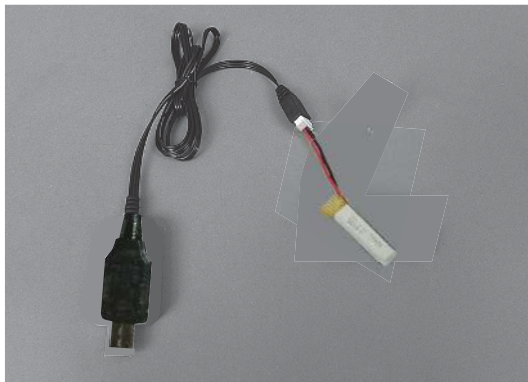

1. Unplug the battery from your plane.
2. Carefully plug the charger into the USB port on your computer or USB adapter.
3. Connect battery into the charger.

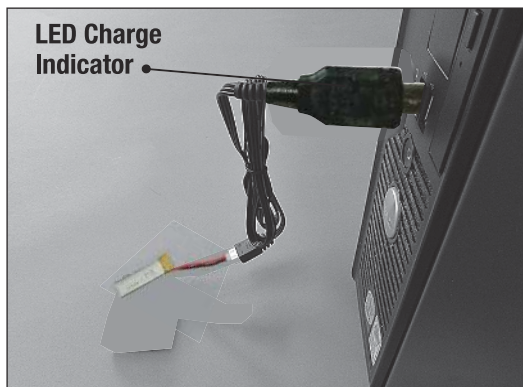

4. The charging process takes about 3.5 hours. For safety reasons, never charge the battery for longer than 4 hours. While charging, the red LED indicator will be flashing. When the charging is finished, the red LED will be off.

Setup Instruction

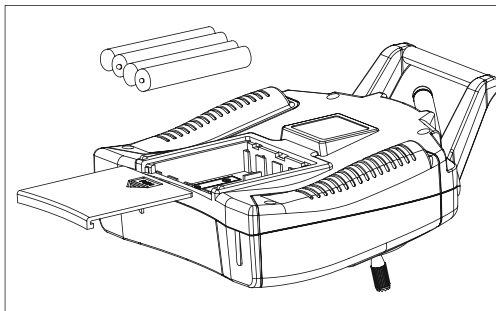

1. Install 4 AA batteries(not included) in the transmitter.

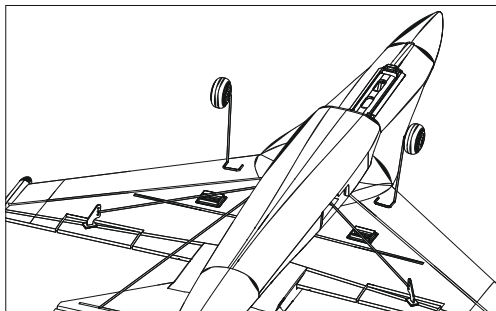

2. Plug the landing gears into the fuselage as shown above, make sure you hear "click" to secure.

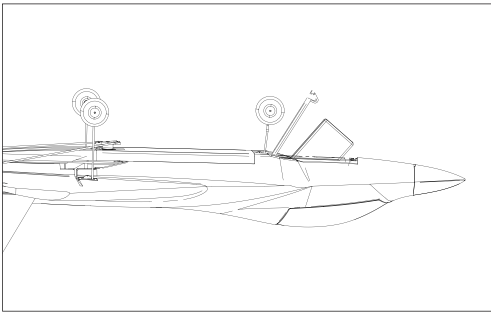

3. Connect the battery to the receiver, then insert the battery into the bottom of fuselage. Secure the battery hatch.

Center Control Surfaces

NOTE: Keep the transmitter power off until you finish the checking of the control surfaces.

With the battery connected to the airplane, it is now possible to check the center of all control surfaces.



Observe the hinges to ensure it is properly centered as shown on the right.

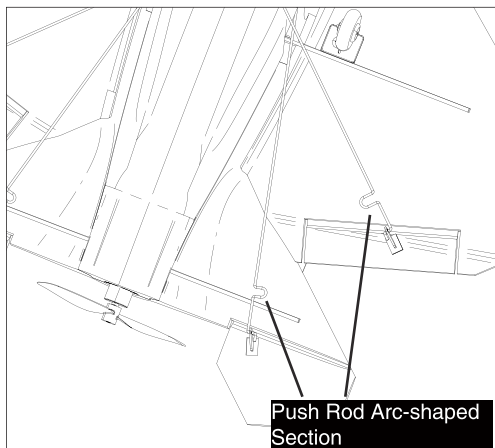

If the hinges are angled off up or down, adjust the push rod by its arc-shaped section slightly, making sure the hinges are properly centered.

Transmitter Instruction

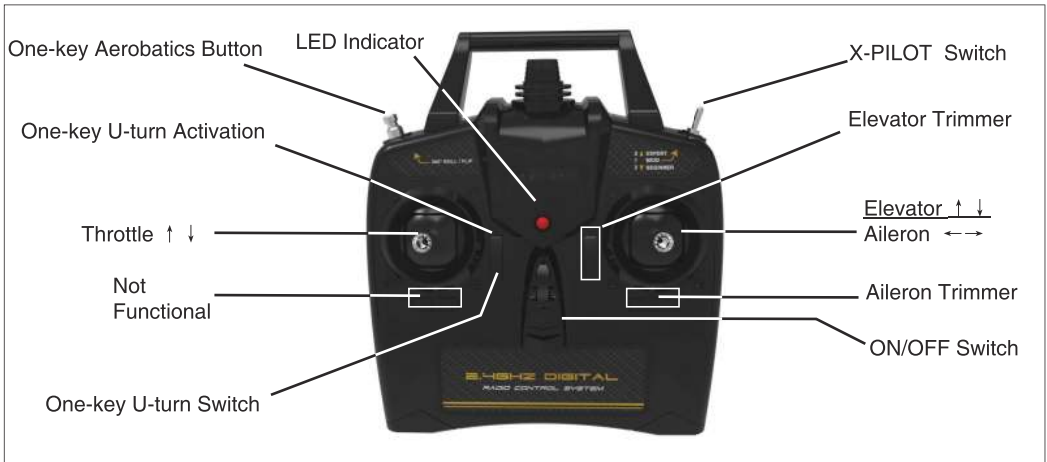

X-PILOT Stabilizer Switch

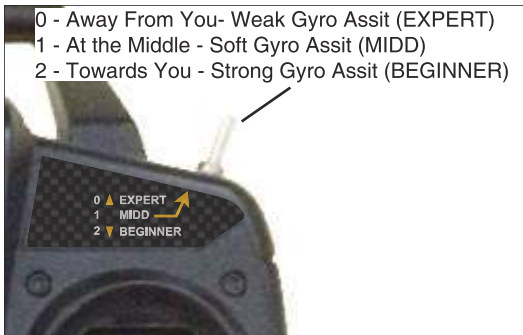

The F-22 comes with X-PILOT stabilizer to help control flying easily. The switch is with 3 levels to control the stabilizer. Needing more X-PILOT assist, switch to upper position(towards you). To gain more manual control, switch to lower position(away from you).

Binding Instruction

Binding is the process of programming the receiver to recognize the GUID (Globally Unique Identifier) code of a single specific transmitter. When a receiver is bound to a transmitter, the receiver will only respond to that specific transmitter.

If you need to rebind for any reason, please follow these steps:

1.Keep the transmitter switched OFF, throttle joystick at bottom position.

NOTICE: Keep Gyro switch at Middle or Beginner position.

NOTICE: Keep the plane still in a calm environment for calculating the Gyro.

2.Connect the battery to the plane, then turn on the transmitter within 5 seconds.

3.The receiver LED will flash for 3-8 seconds to bind automatically.

4.After the receiver LED stop flashing, it means the binding process is done.

Follow below steps when you operate a bound plane:

1.Power on transmitter first.

2.Connect the battery to the plane within 3 seconds.

3.The receiver LED in plane will flash and then turn to solid in several seconds.

4. Turn throttle stick up to max and then down to min to arm the motor.

CAUTION: Do **NOT** operate around people or property, otherwise it may cause serious damage!

Throttle Unlock(Arming)

To prevent from damages, the throttle channel is locked each time when powering on your transmitter. Follow below instruction to unlock the throttle.

CAUTION: Keep the propeller in distance for your safety.

Turn the throttle stick up to max position until you hear a "beep" sound. Then turn the throttle stick down to min position until you hear a "beep" sound.

Now the throttle is unlocked.

Digital Trims

Digital trims allow to adjust the centered position of rudder or aileron hinge.

Each time when a trimmer is moved, the servo output will change one step. If the trimmer is held, the output will scroll in that direction until the trimmer is released or the output reaches its end. When you hear a short "beep" sound, it means the trimmer is centered.

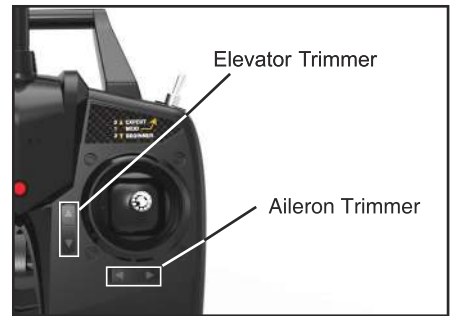

Channels Reactions Checking

Transmitter Operaton	Reaction

Swing The Plane	Gyro Reaction

Place your plane in a neutral position, follow below steps to check the channels reactions. Move the sticks(except the throttle stick) to see if all servo surfaces react correctly as shown in the left diagram(left throttle for example). Swing your plane to check if all servo surfaces react correctly as shown in the right diagram.

One-key Aerobatics Instruction

The one-key aerobatics feature allows beginner pilot to perform aerobatic actions by simply pressing the button on transmitter.

During flight, press the one-key aerobatics button, the transmitter will beep several times. During the beeping, simply move the aileron stick to either direction for auto-roll. Or move the elevator stick to either direction for auto-loop.



One-key U-turn Instruction

The F22 Raptor comes with one-key U-turn function, which enable the plane to return by the opposite direction that the plane takes off.

Follow below steps to activate the function.

1. Place your plane heading to the take-off direction.
2. Do **NOT** unlock the throttle, press the activation button and hold for several seconds until you hear a "beep" sound, the rudder surface will respond, meaning the one-key U-turn function is now activated.

NOTICE: Every time when you power on the plane, it requires to activate the one-key U-turn function.

To use this function during flight, press the one-key U-turn switch button, the plane will turn around automatically, back to the opposite direction where it takes off.

To quit, just press again the switch button, or control any servo stick (rudder/elevator), the plane will back to your control immediately. No matter you fly the plane under manual control or gyro assist mode, when you turn on the one-key U-turn function, the plane will enter gyro assist mode automatically to help stable flying back. When you quit this function, the plane will back to the what the control mode it was.

CAUTION: This function is bound to the receiver, instead of to the transmitter, which means the plane will return **ONLY** to the opposite direction that the plane takes off. It also means when the plane returns and passes the position where you activated the function, the one-key U-turn function will **NOT** return the plane back to the take-off position.

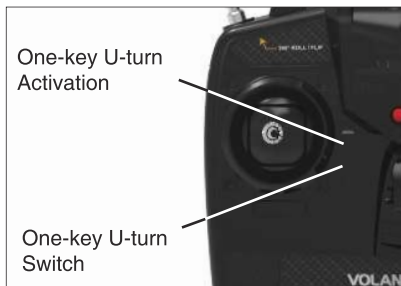

Gyro System Calibration

1. Turn the throttle stick to min position.
2. Power on the transmitter and the receiver.
3. Do **NOT** unlock the throttle.
4. Keep the sticks as above picture for several seconds.
5. When you hear a "beep" sound, it means the gyro system is calibrated based on the horizontal level you are keeping it.



Flight Checklist

NOTE: This checklist is NOT intended to replace the content included in this instruction manual. Although it can be used as a quick start guide, we strongly suggest that read all though the manual completely before proceeding.

- Always turn the transmitter on first.
- Ensure the throttle control stick is at bottom position before connecting the battery.
- Fly the model(hand-launch or take off from a flat/level surface).
- Land the model(on a flat/level surface).
- Unplug the battery from ESC.
- Always turn off the transmitter last.

Find a Flight Field

Based on the size and weight of the plane it is typically considered to be a "park flyer" class airplane. As a result it is best to fly the plane at a local park, schoolyard, flying field or other area that is large enough and free of people and obstructions. We recommend an area the size of at least one football/soccer field. However, even larger areas are better suited and preferred especially when learning how to fly. Do NOT fly in parking lots, crowded neighborhood areas or in areas that are not free of people or obstructions.

We also suggest flying over grass as it is a much more forgiving surface that causes less damage in the unfortunate event or a crash. Short grass is better for takeoffs and landings as grass that is too long can cause the airplane to nose-over/flip and be damaged. An ideal flying area allows for takeoffs and landings on a smoother surface(such as asphalt) and flying over grass.

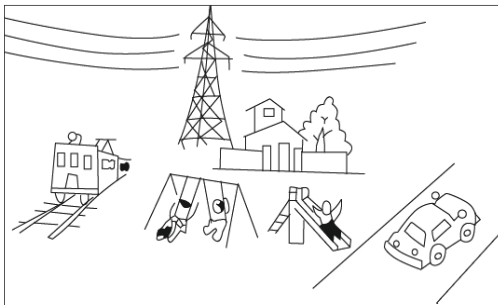
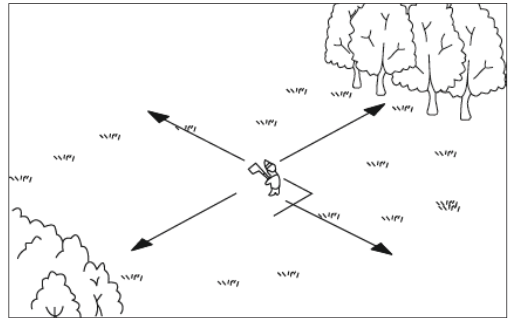

Fly in spacious ground without obstacles and boskage.

Never fly the plane near highway, railway, high tension line, crowded people, flying area and residential area.

NOTE: The plane is designed to be flew outdoors only.

Flying Conditions

It is typically best to fly on days that are calm without wind, especially when learning how to fly. It is strongly suggested flying only in calm conditions until you are familiar with the controls and handling of the model. Even light winds can make it much more difficult to learn to fly, and in some cases can even carry the model beyond your line of sight.

Also, if you are a first-time or low-time pilot, we highly recommend that allow a more experienced pilot to test fly and properly trim the model before attempting your first flight. A proven flyable and properly trimmed model is significantly easier and more enjoyable to fly.

After you have properly trimmed the airplane in calm conditions and become familiar with its handling/capabilities you will be able to fly in light winds or depending on your experience and comfort level, in winds up to 5-7 mph.

Do NOT fly on days when significant moisture, such as rain or snow, is present.

VOLANTEX RC

PRODUCED, DESIGNED
AND BACKED BY **EXHOBBY**