



www.flitetest.com

FT Mini Scout

Designed By: Josh Bixler
Drawing By: Dan Sponholz
Version: 1.1
Date: 2017.09.08



SPECIFICATIONS

DESCRIPTION		IMPERIAL	METRIC
LENGTH		18.0 in	457.2 mm
CENTER OF GRAVITY	CG	2.0 in	44.0 mm
WING SPAN		24.0 in	609.0 mm
WING AREA		132.16 in ²	8.5 dm ²
DRY WEIGHT		4.05 oz	115.0 g
ALL UP WEIGHT	AUW	5.82 oz	165.0 g
WING LOADING	WL	6.34 oz/ft ²	19.4 g/dm ²
WING CUBIC LOADING	WCL	6.6	

RECOMMENDED SETTINGS

	THROW	EXPO
ELEVATOR	16°	25%
RUDDER	16°	25%



Build Skill Level :



Pilot Skill Level :





FT Mini Scout: Sheet & Tile Key

A17 B9 A18	A19 B10 A20
A21 B11 A22	A23 B12 A24

A9 B5 A10	A11 B6 A12
A13 B7 A14	A15 B8 A16

A1 B1 A2	A3 B2 A4
A5 B3 A6	A7 B4 A8

A41 B21 A42	A43 B22 A44
A45 B23 A46	A47 B24 A48

A33 B17 A34	A35 B18 A36
A37 B19 A38	A39 B20 A40

A25 B13 A26	A27 B14 A28
A29 B15 A30	A31 B16 A32

A65 B33 A66	A67 B34 A68
A69 B35 A70	A71 B36 A72

A57 B29 A58	A59 B30 A60
A61 B31 A62	A63 B32 A64

A49 B25 A50	A51 B26 A52
A53 B27 A54	A55 B28 A56



Drawing Key



FOLD TYPES

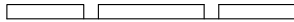
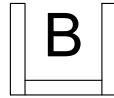
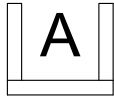

A - FOLD (ABOVE)

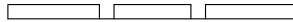

B - FOLD (BESIDE)

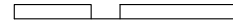

C - FOLD (COVER)

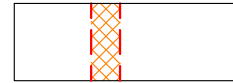
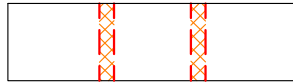

LINE TYPE/COLOR

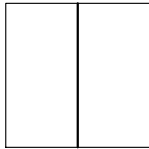

CUT

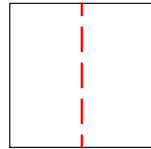

50% SCORE

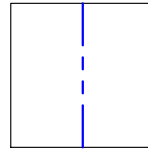
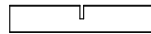

CREASE

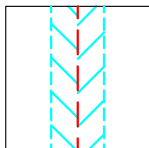
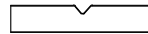

45° DOUBLE BEVEL

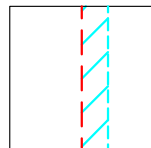

45° SINGLE BEVEL

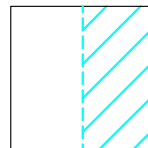

EDGE BEVEL

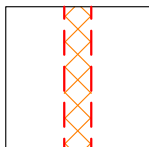
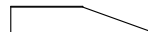

CAVITY

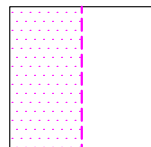

REMOVE PAPER

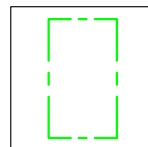

REFERENCE/
OPTIONAL

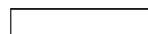

SYMBOLS

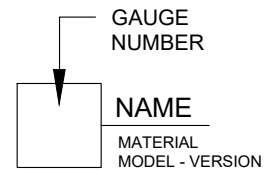
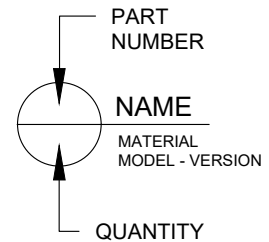

CENTER OF GRAVITY (CG)

FT Mini Scout

Designed By: Josh Bixler
 Drawing By: Dan Sponholz
 Version: 1.1
 Date: 2017.09.08

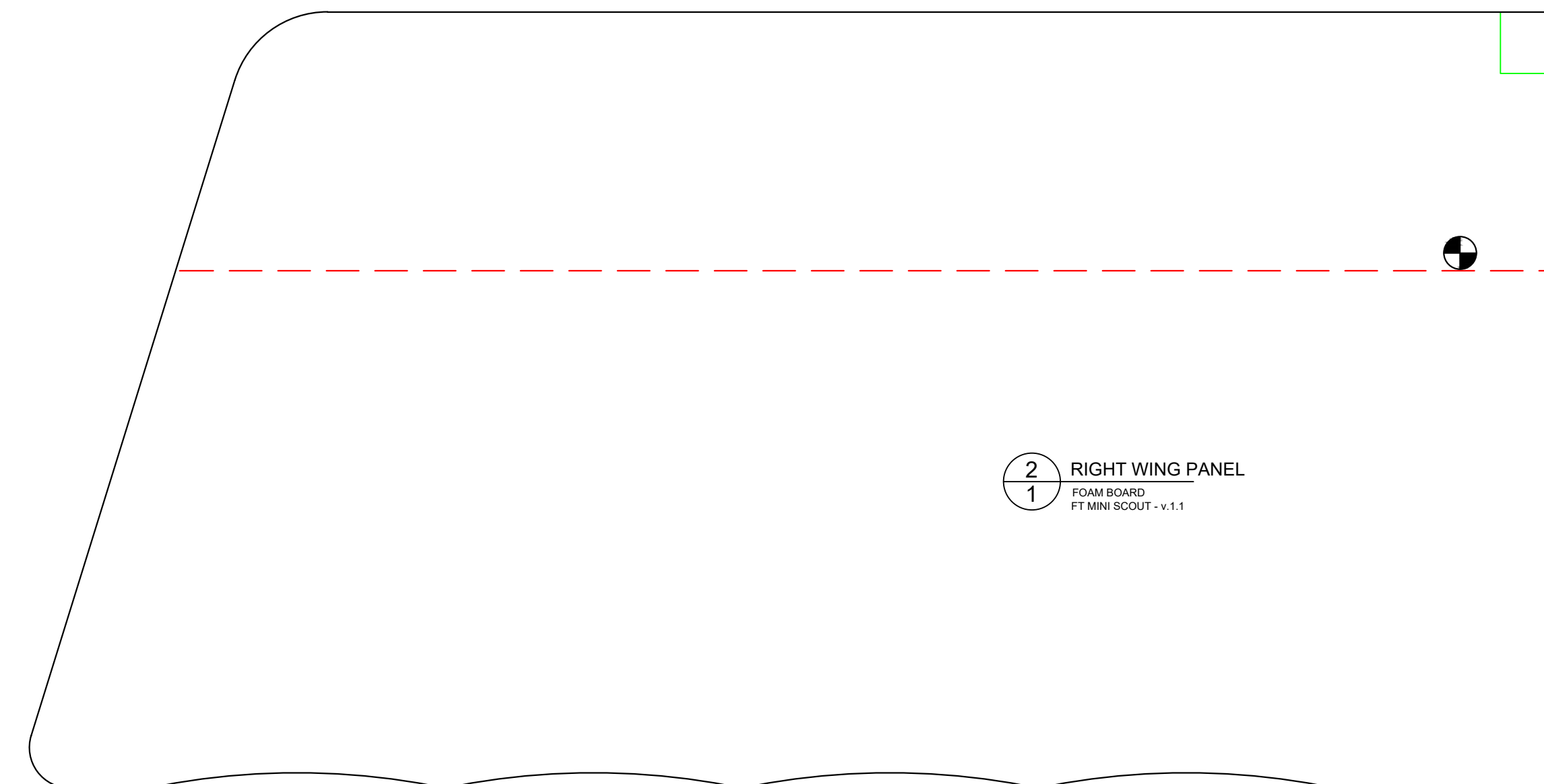
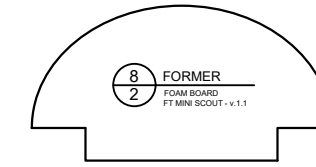
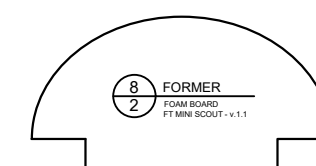
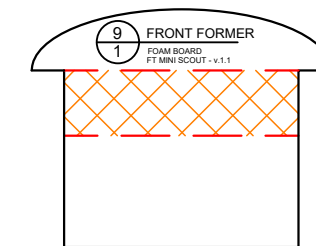
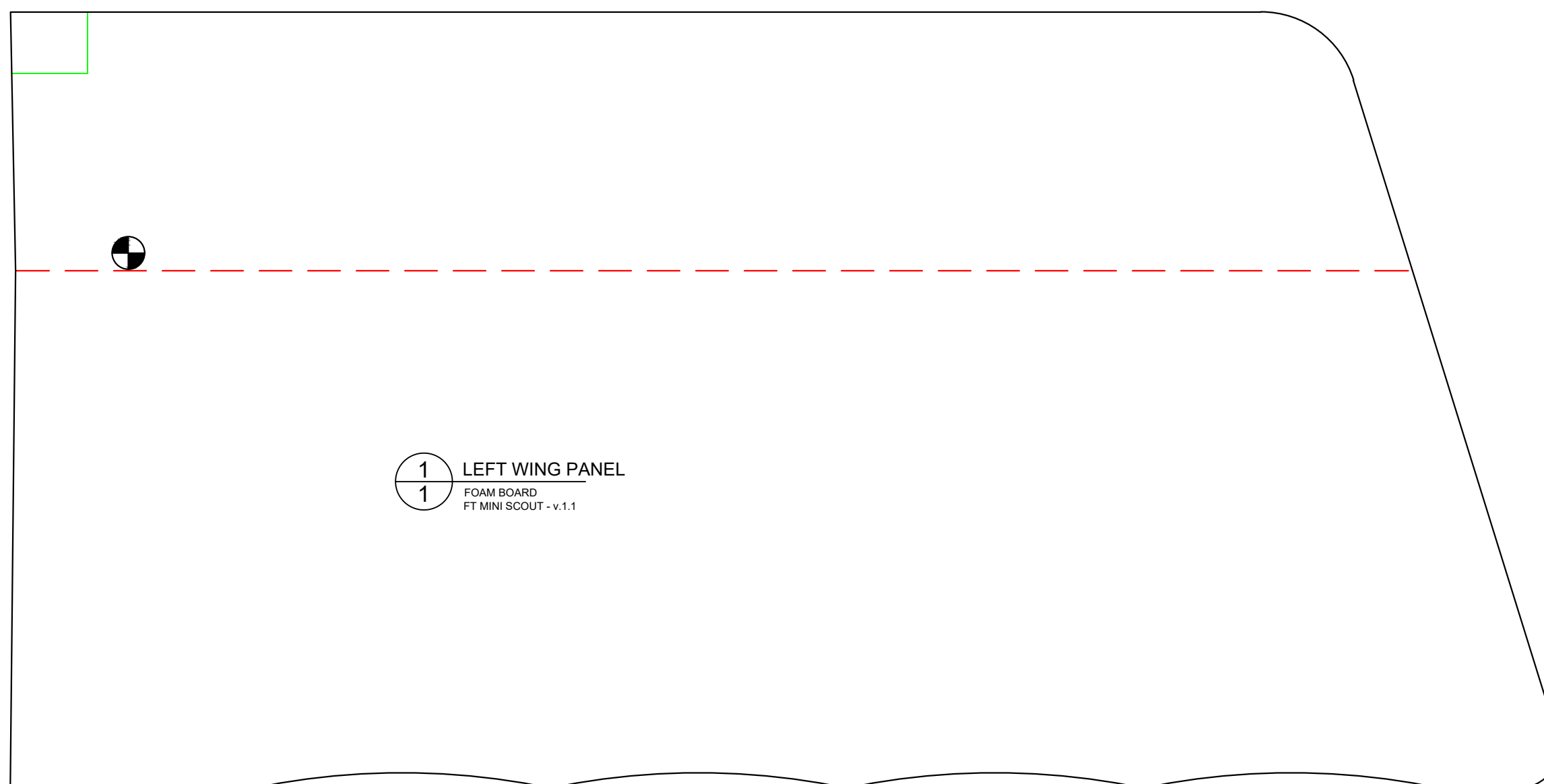
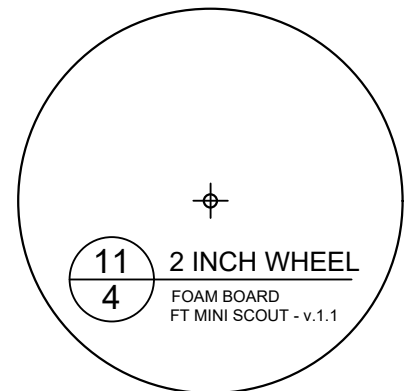
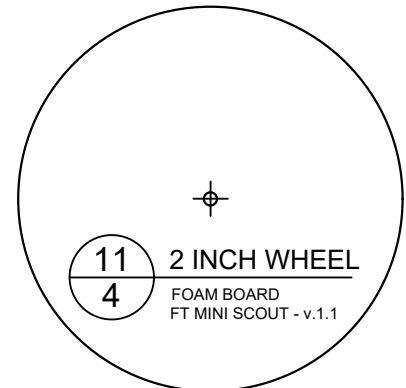
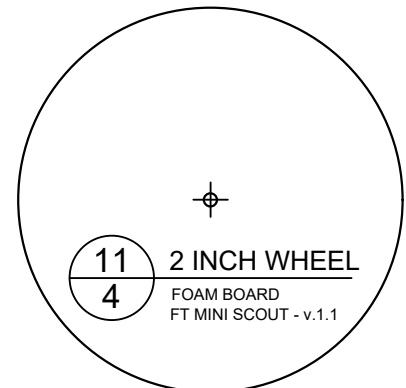
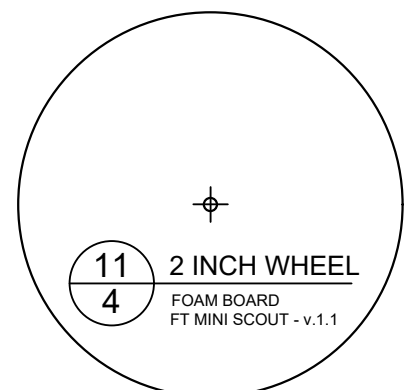
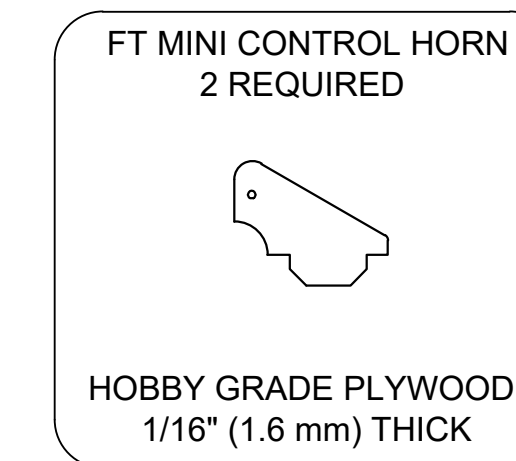
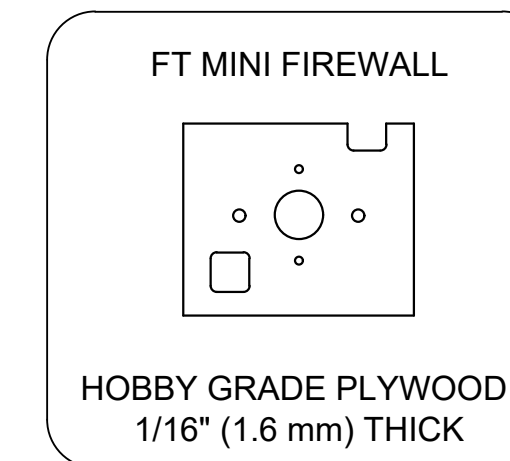
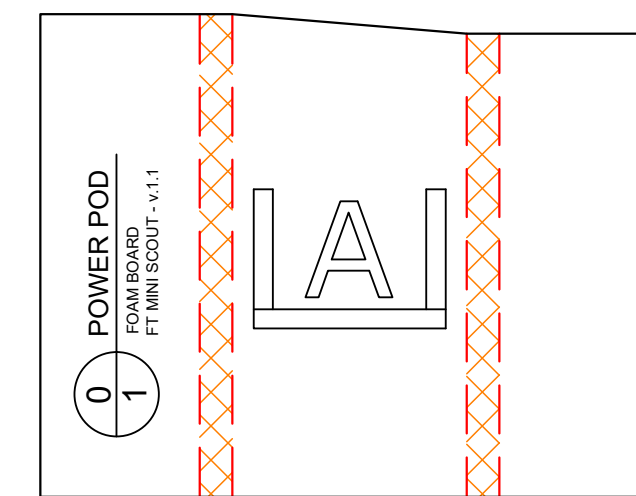
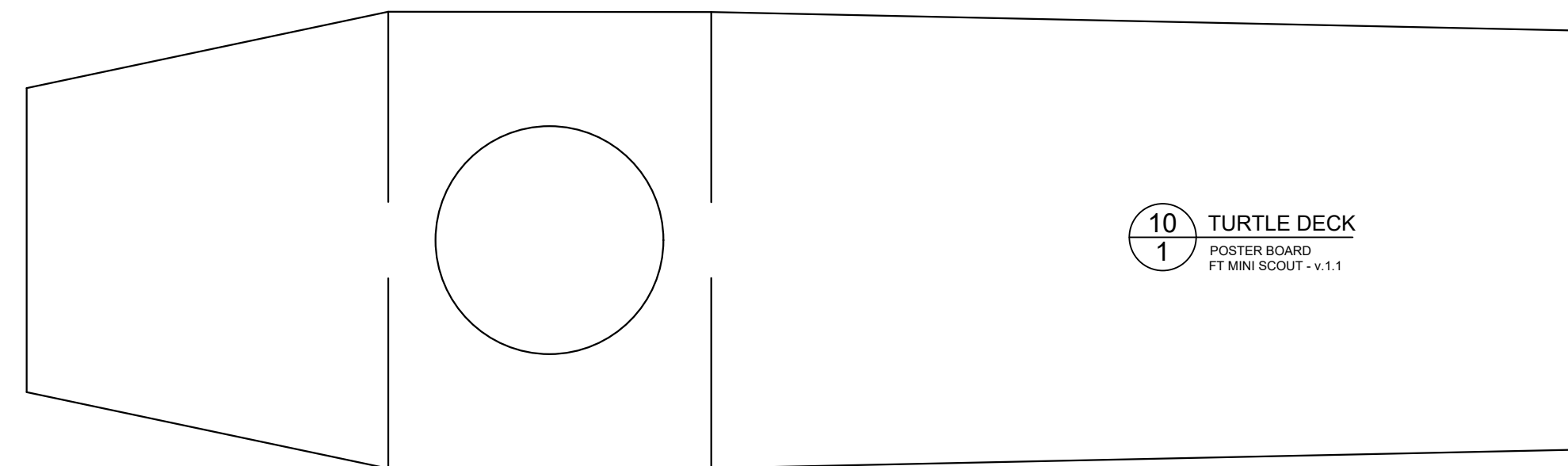
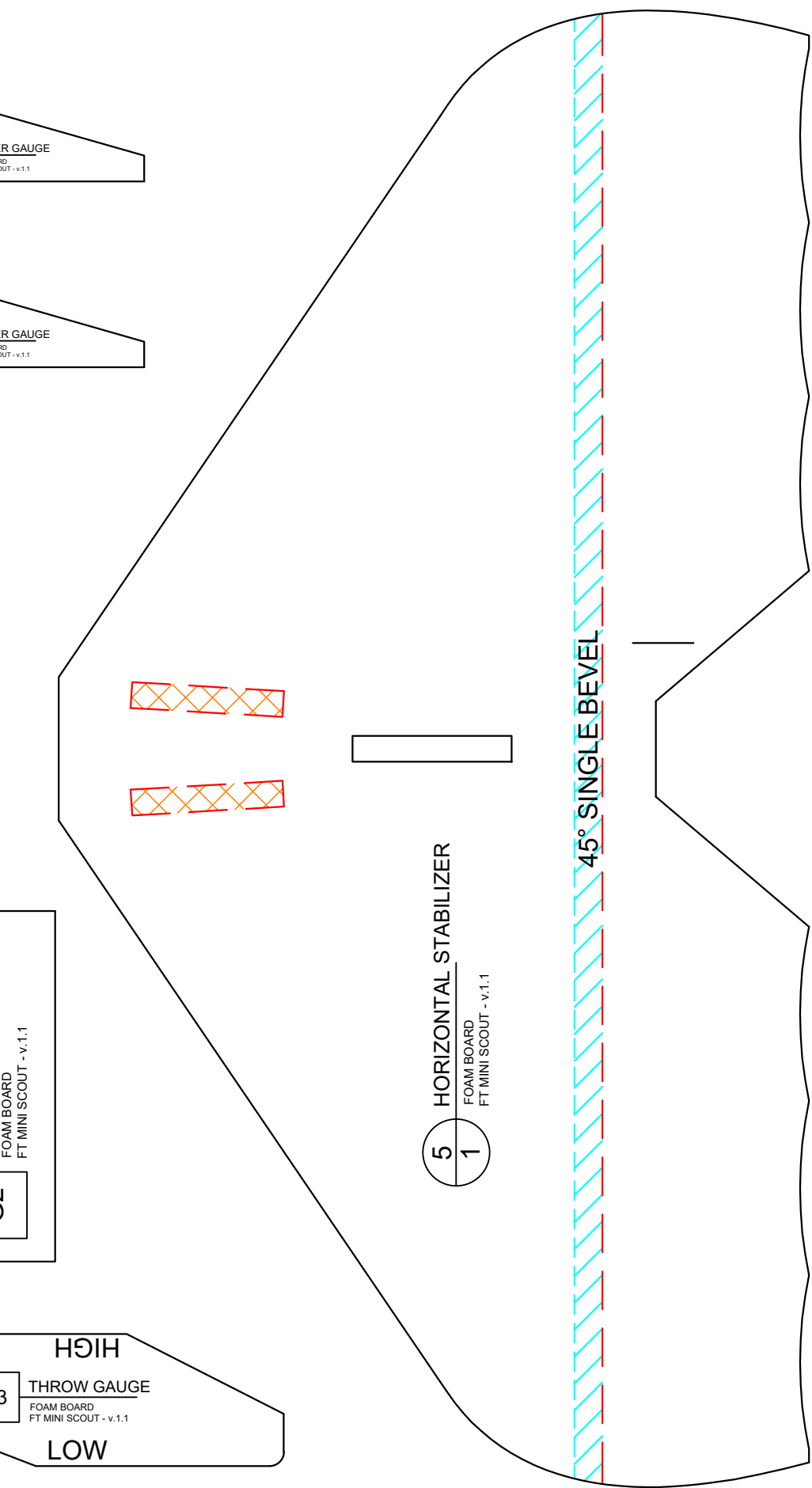
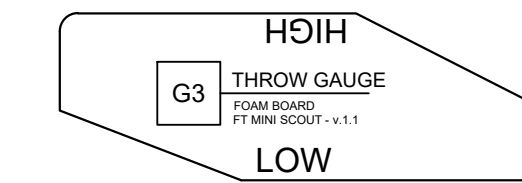
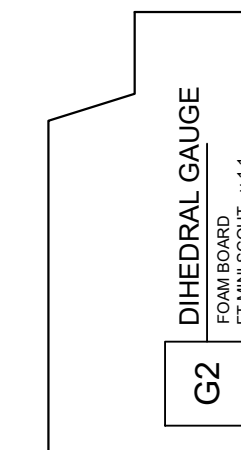
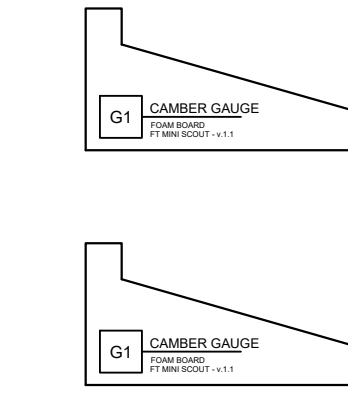
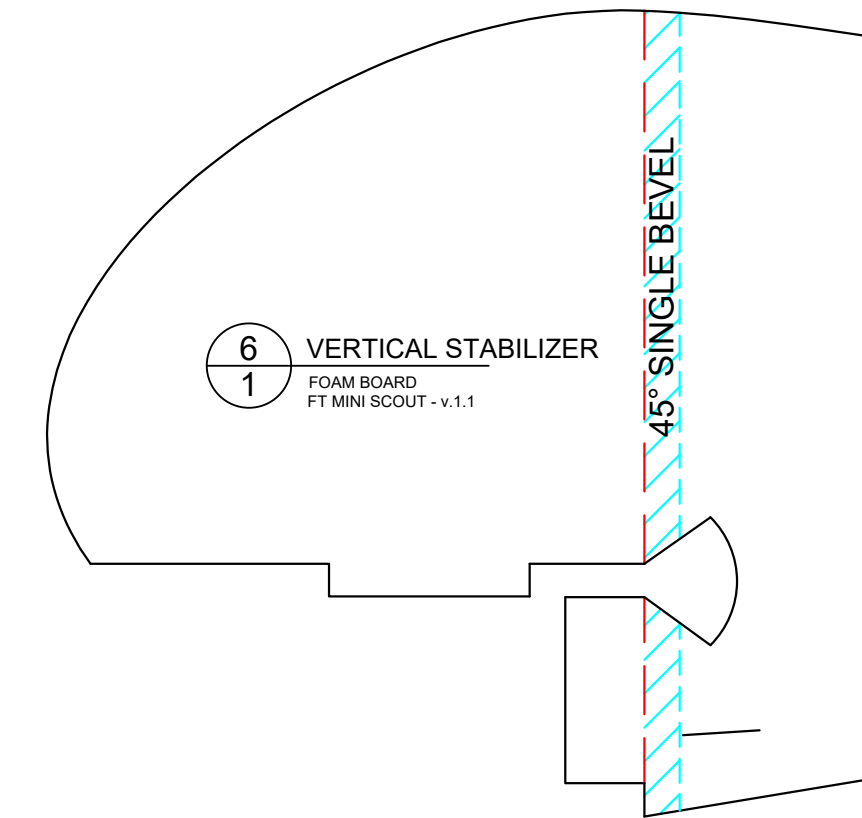
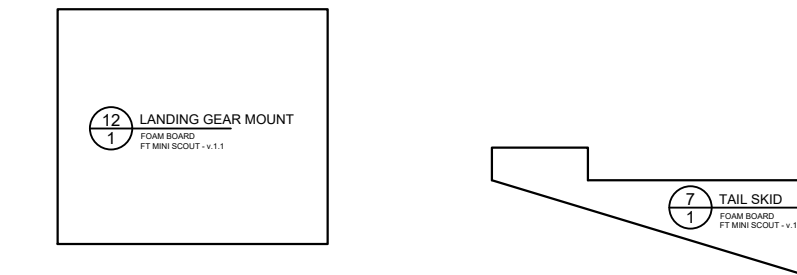
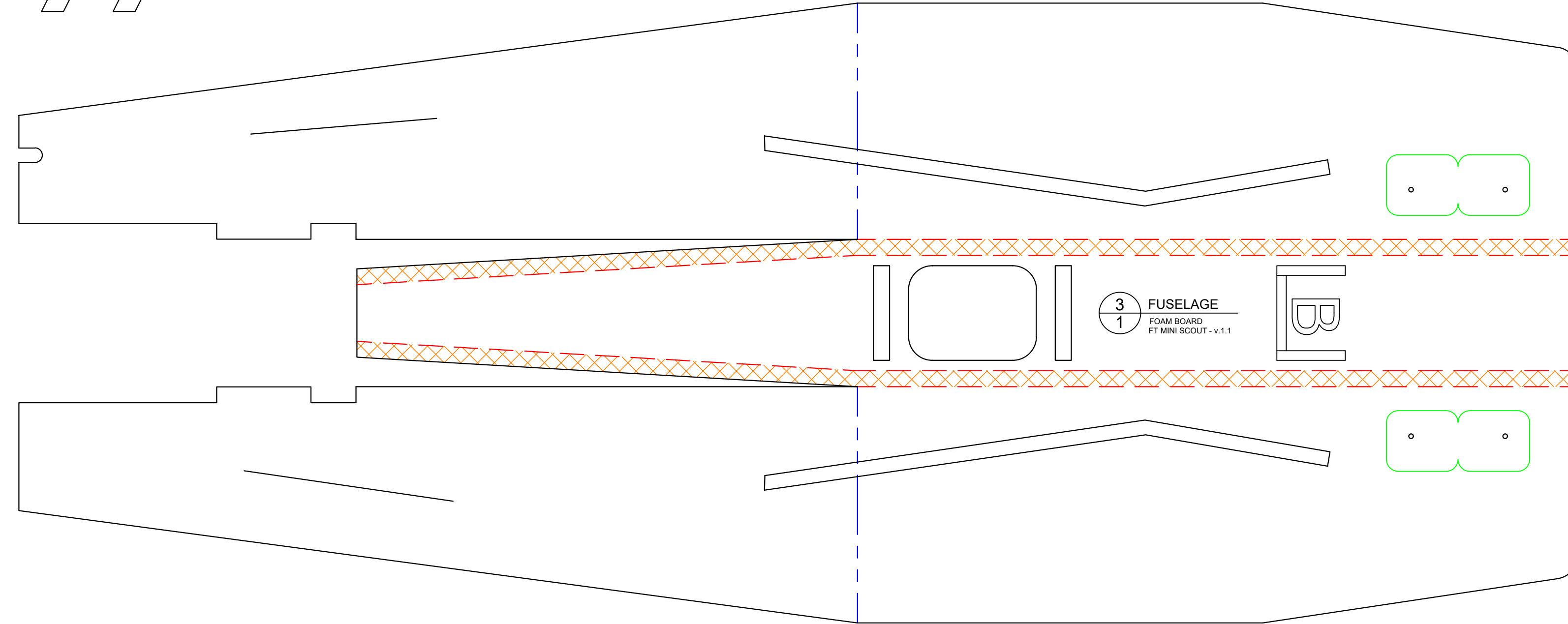
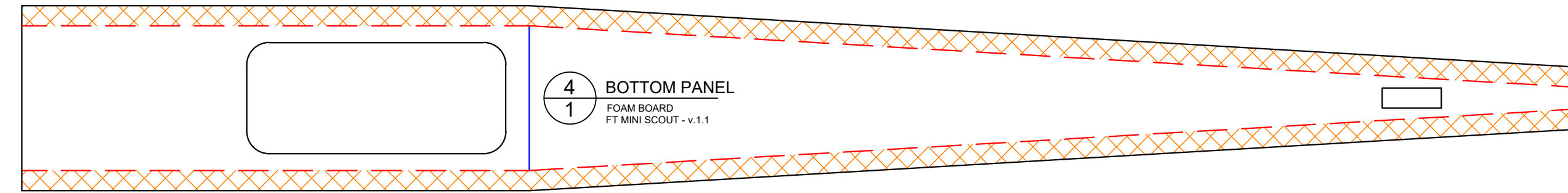
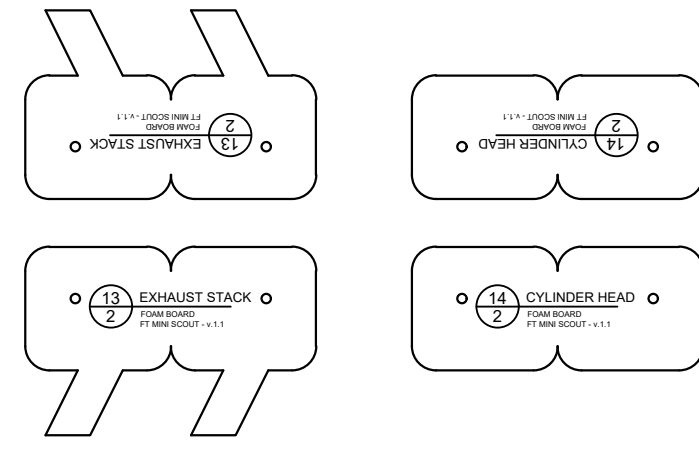
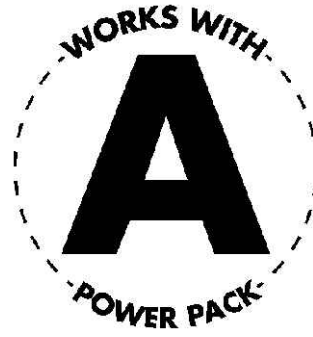



IN
CM

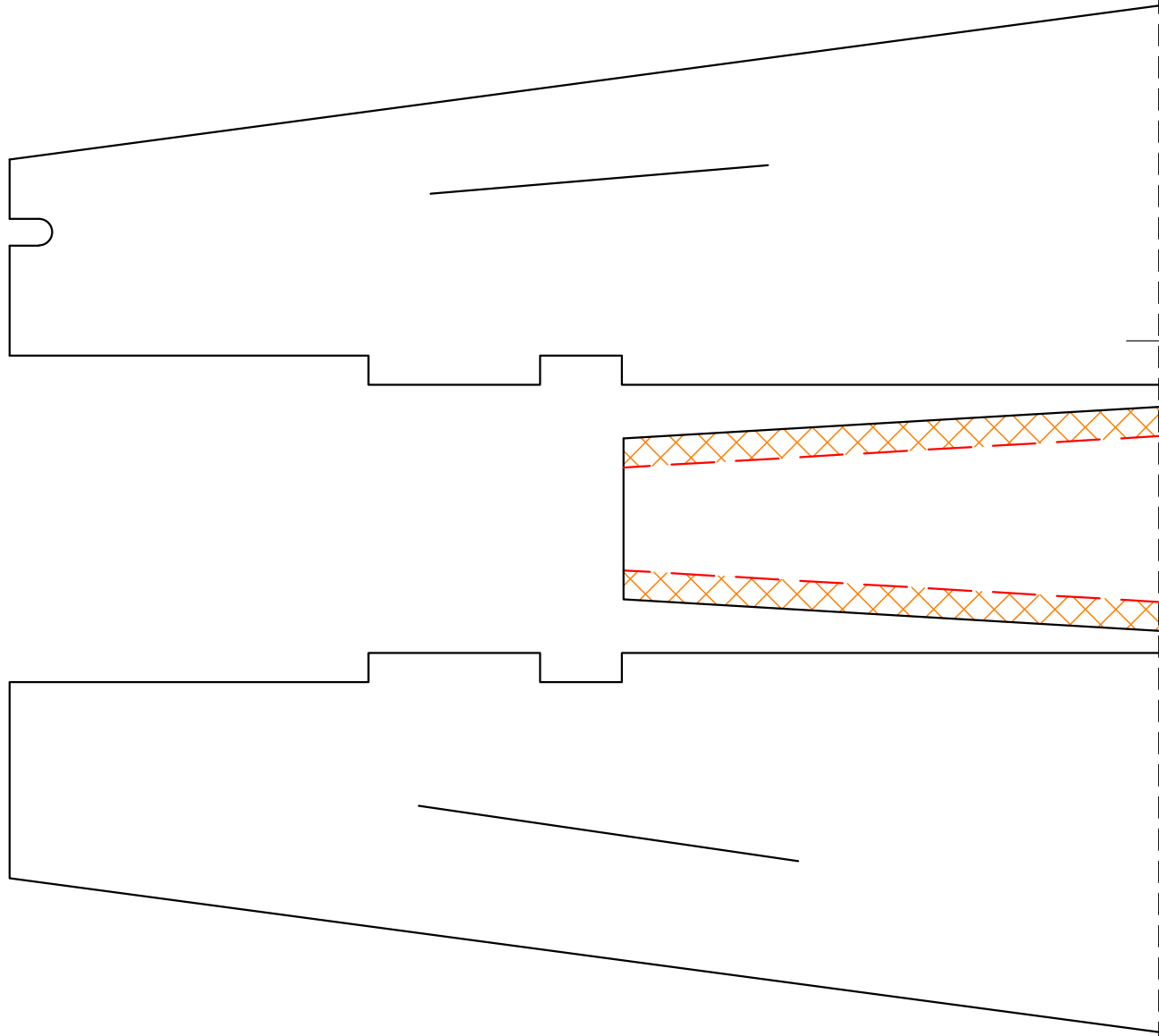
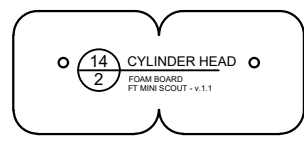
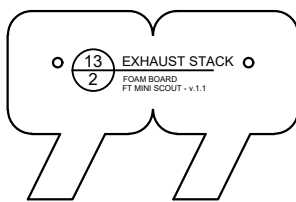
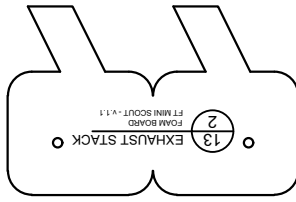

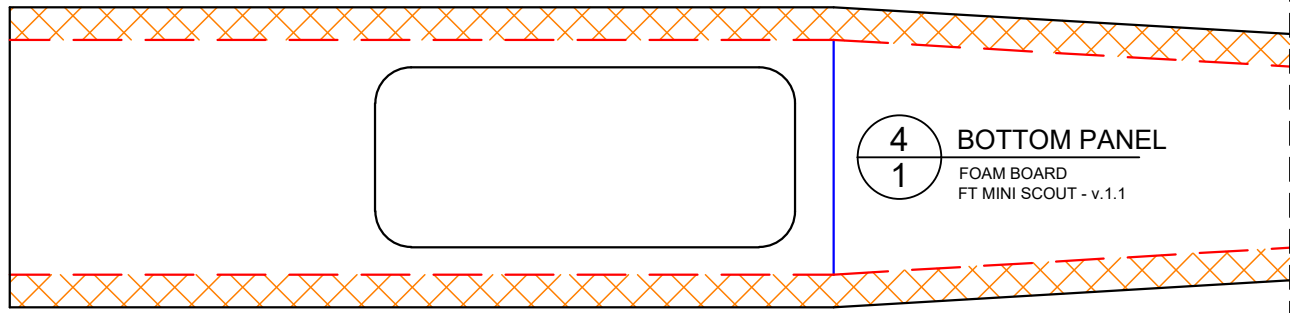

4 BOTTOM PANEL
1 FOAM BOARD
FT MINI SCOUT - v.1.1

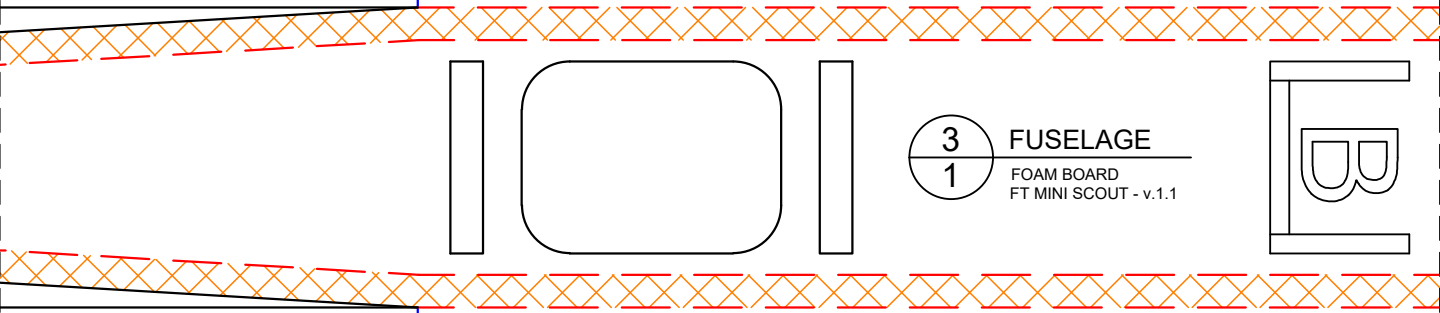
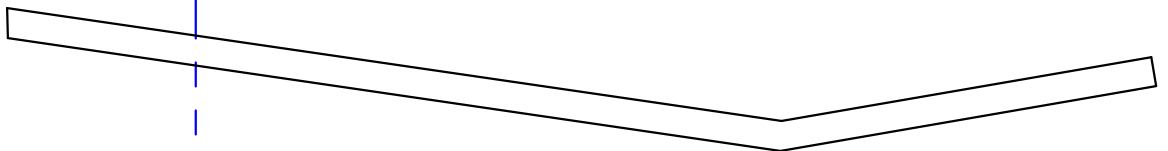
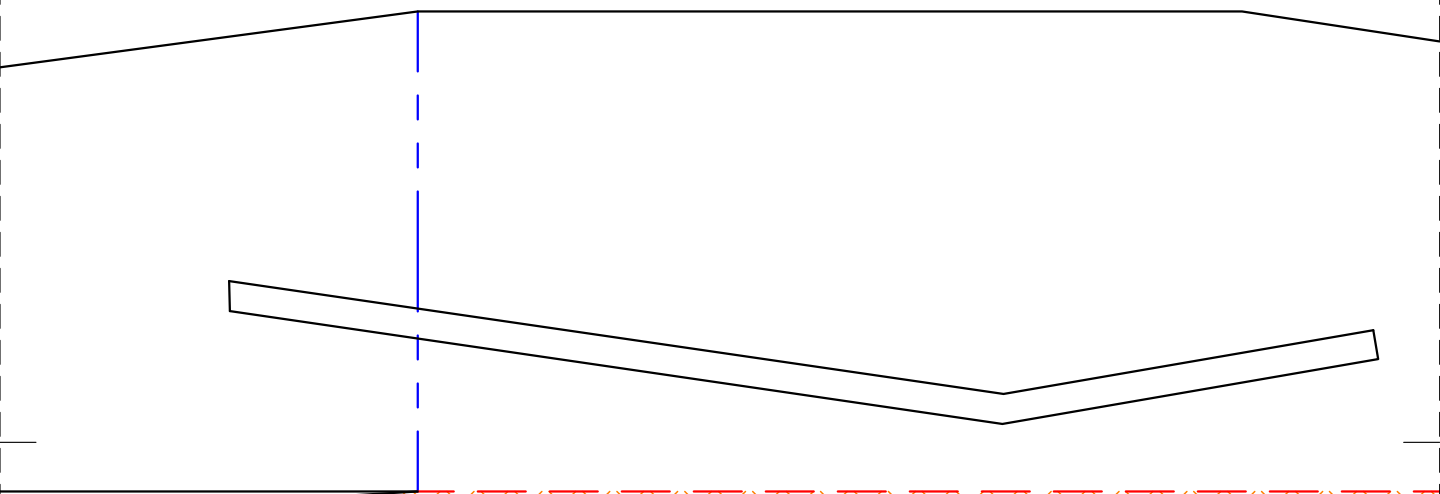

3 FUSELAGE
1 FOAM BOARD
FT MINI SCOUT - v.1.1

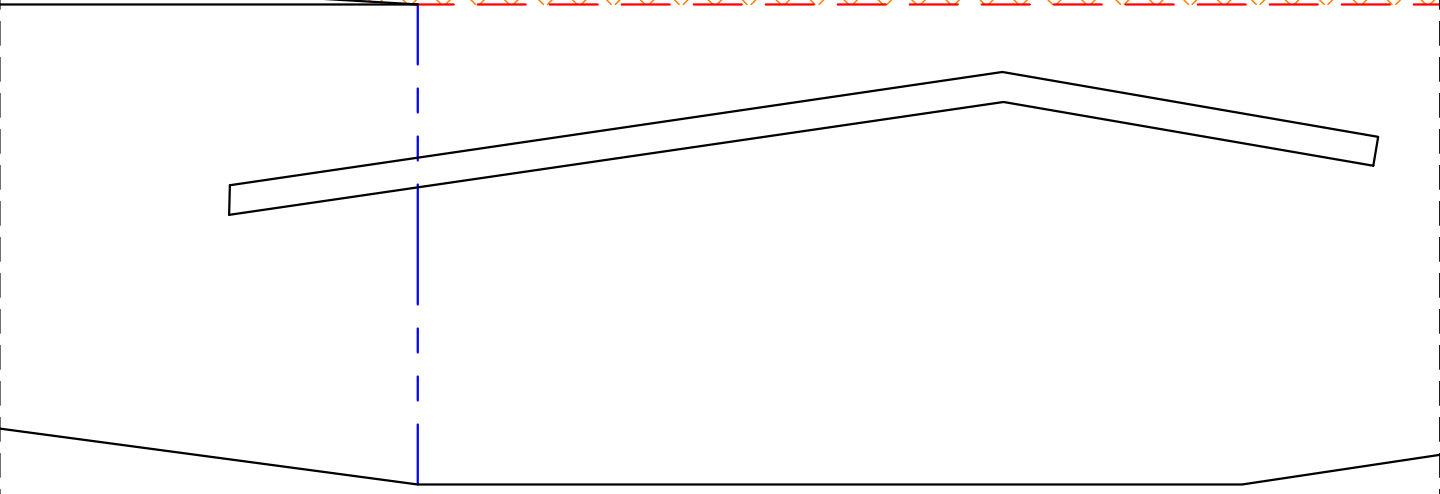
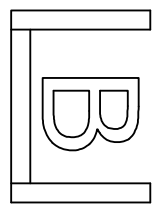

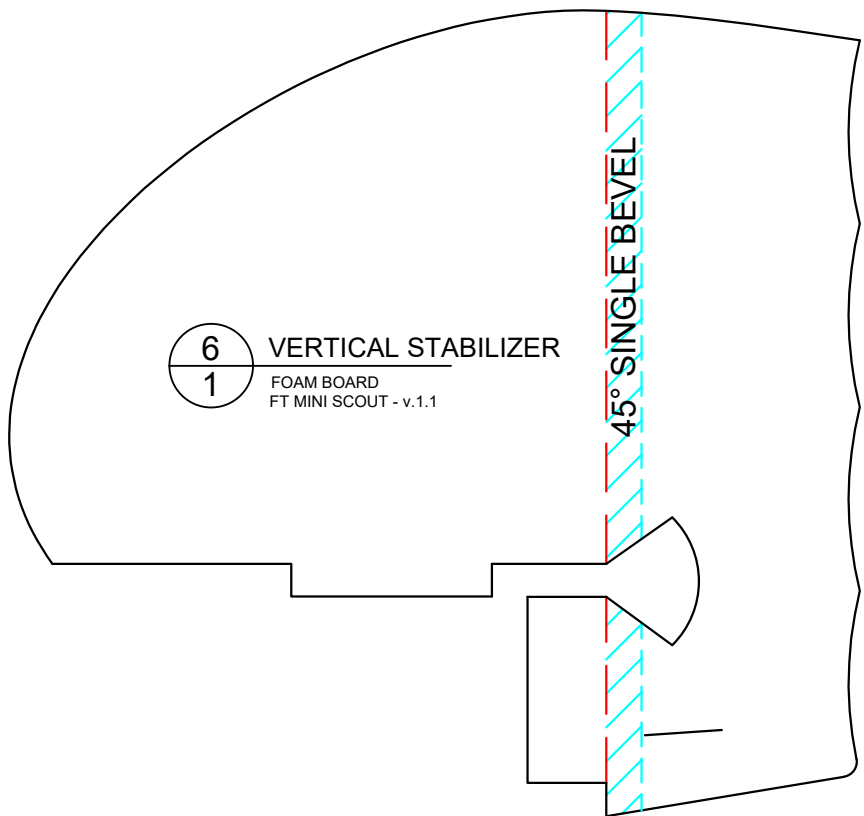
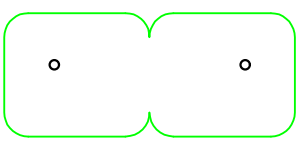
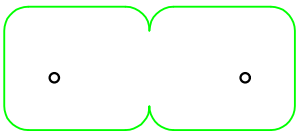
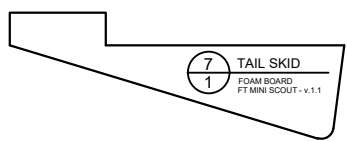
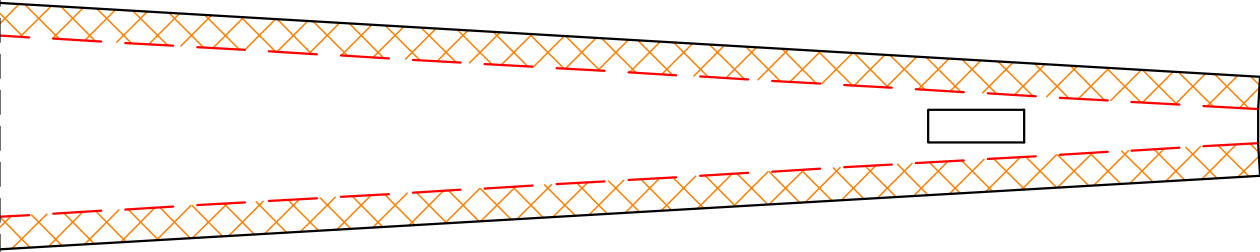

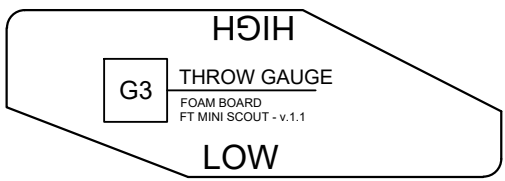
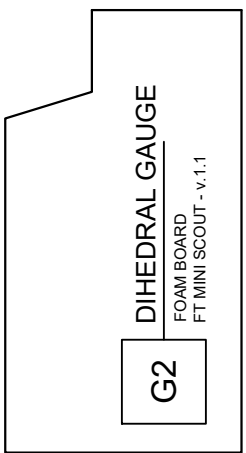
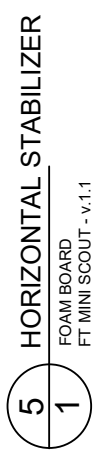
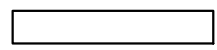
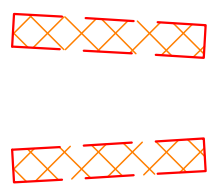
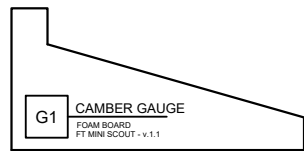
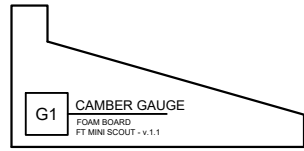

45° SINGLE BEVEL

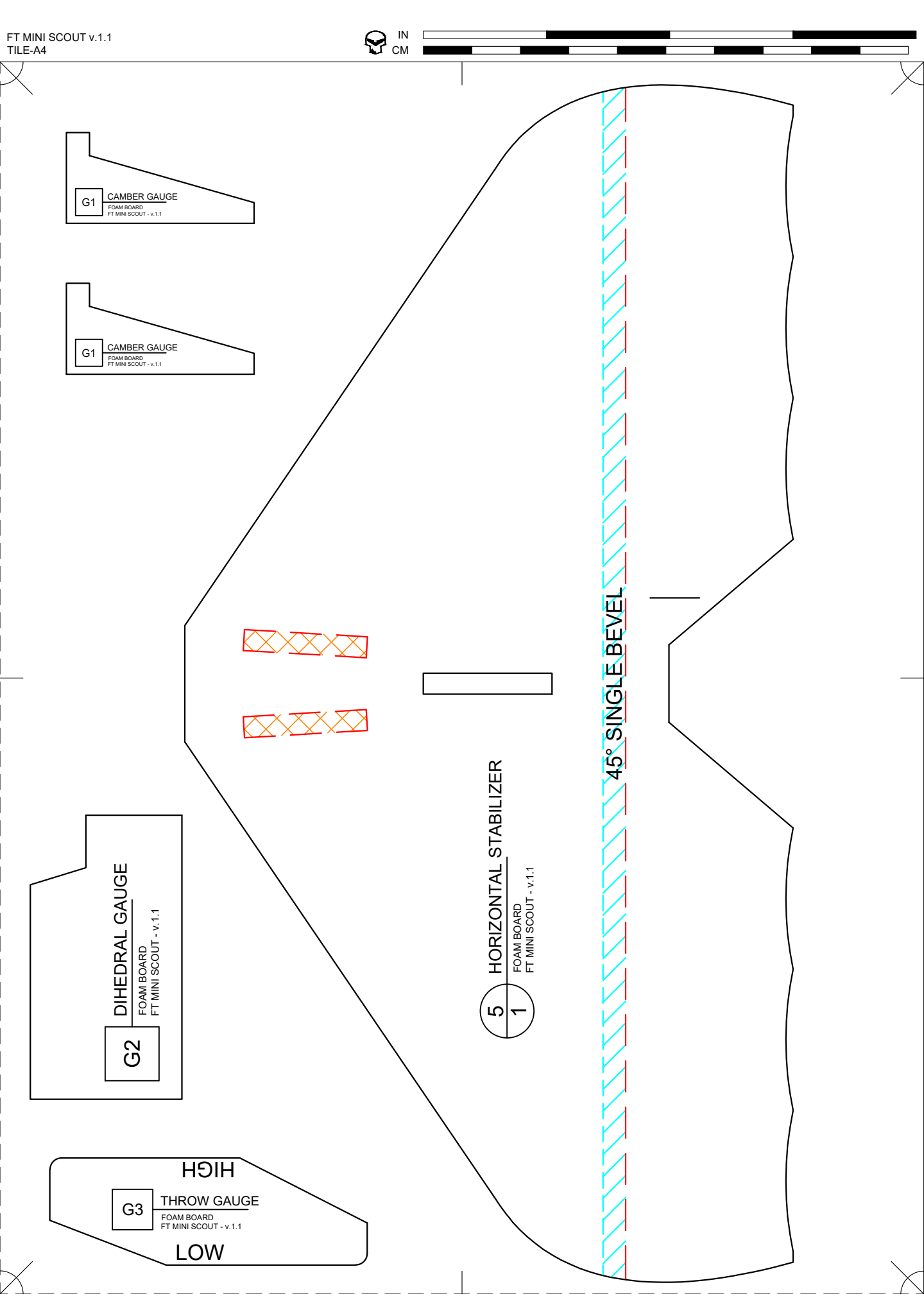

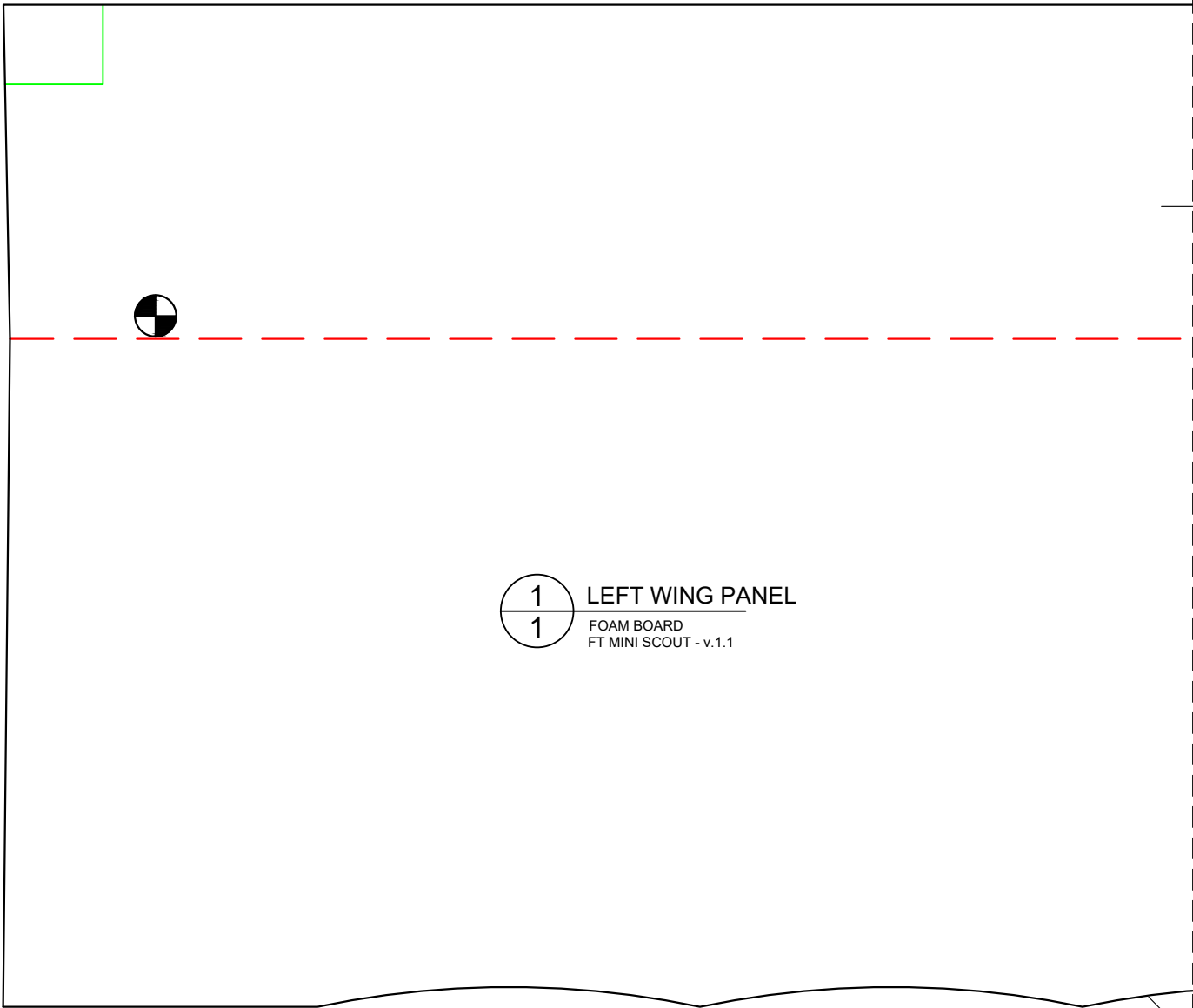
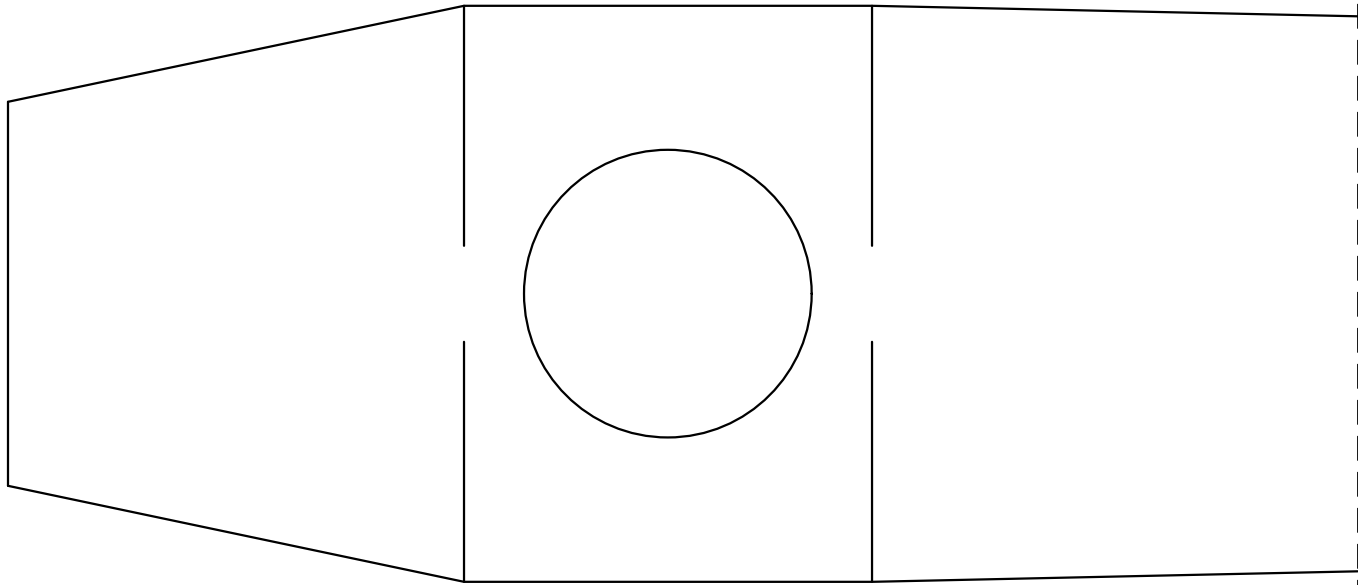

1 LEFT WING PANEL
FOAM BOARD
FT MINI SCOUT - v.1.1



10 **TURTLE DECK**
1 POSTER BOARD
FT MINI SCOUT - v.1.1

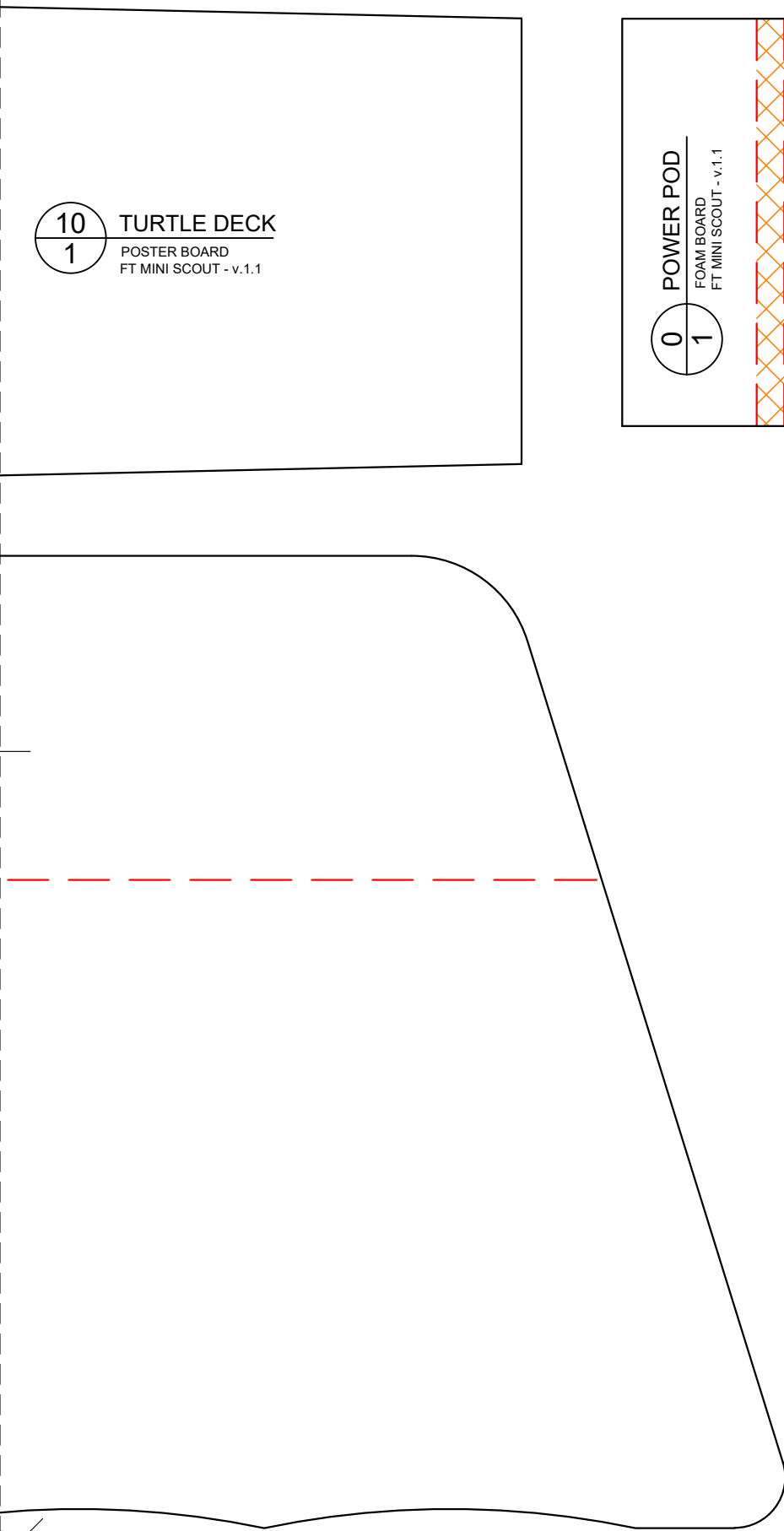
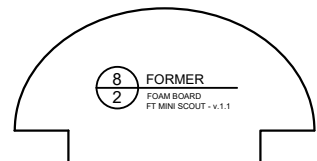
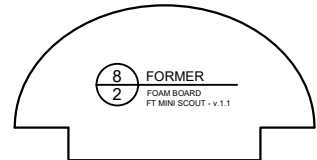
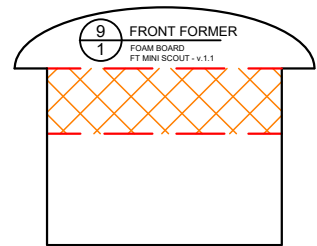
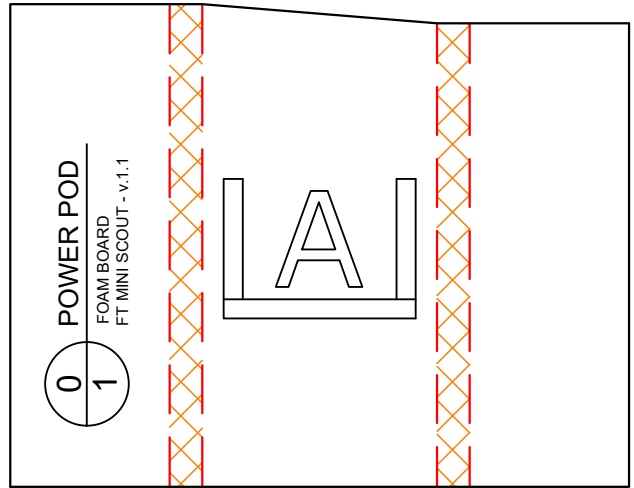

FT MINI FIREWALL

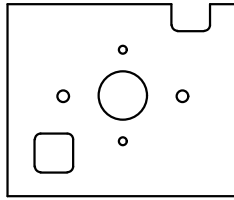

HOBBY GRADE PLYWOOD
1/16" (1.6 mm) THICK

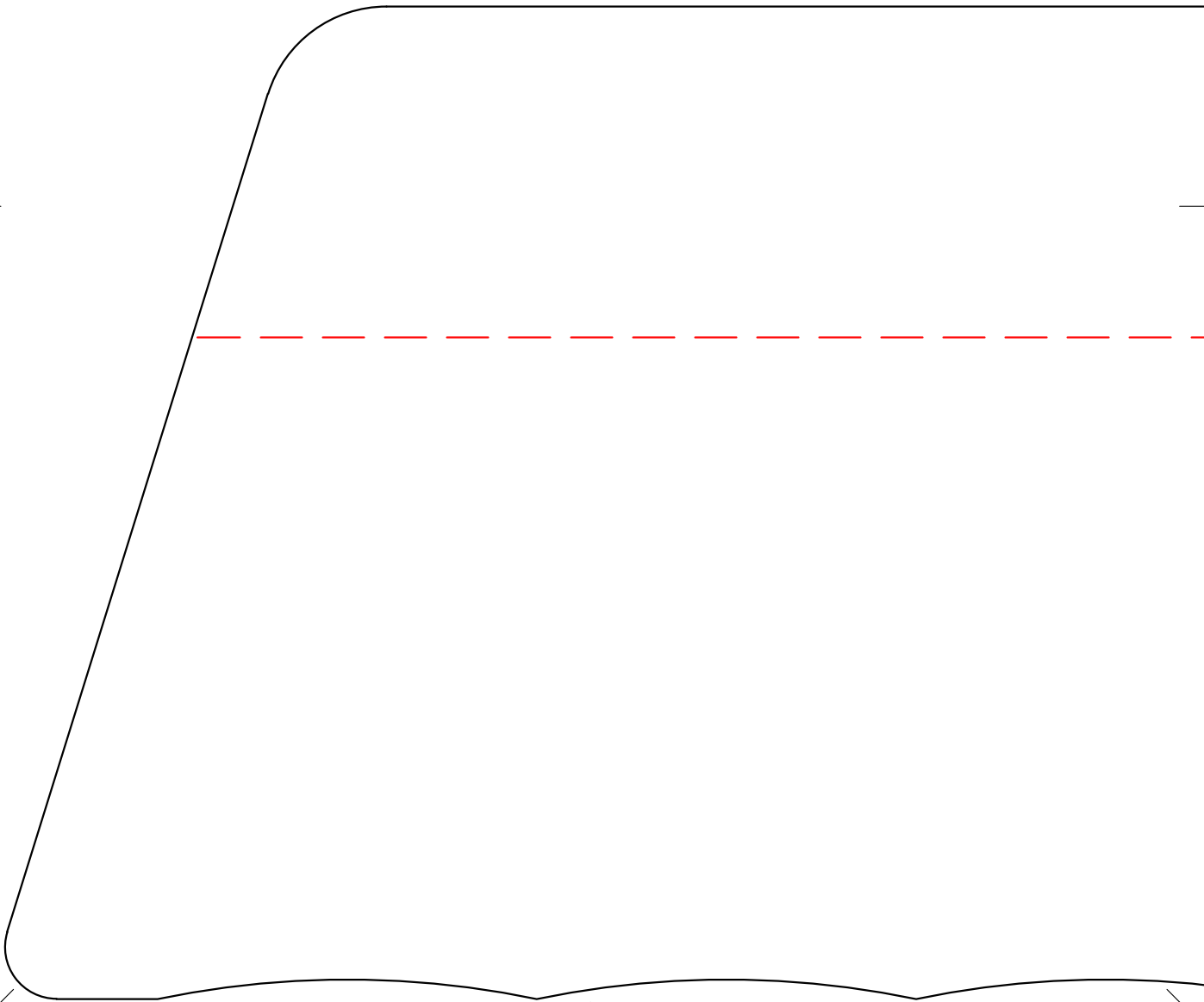

FT MINI CONTROL HORN
2 REQUIRED

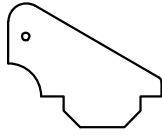

HOBBY GRADE PLYWOOD
1/16" (1.6 mm) THICK

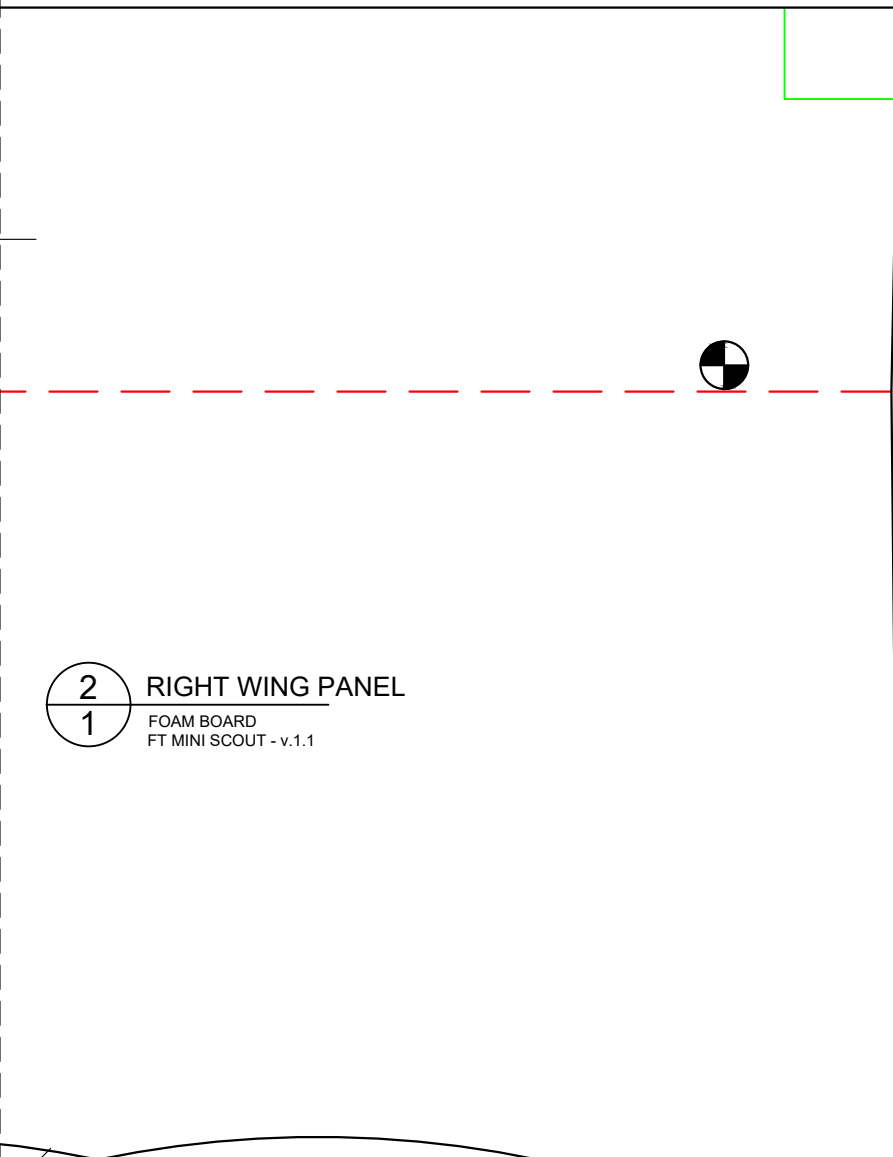
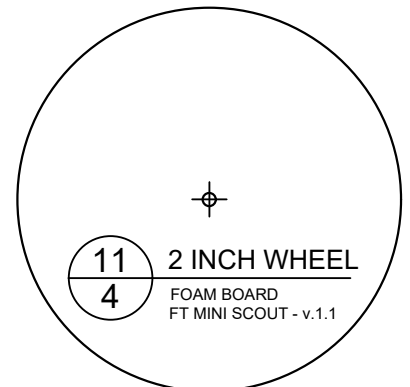
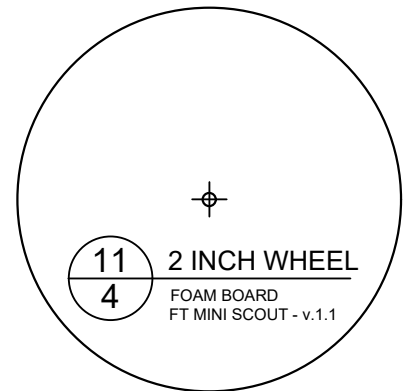
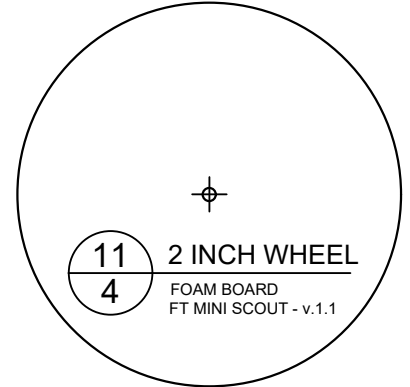
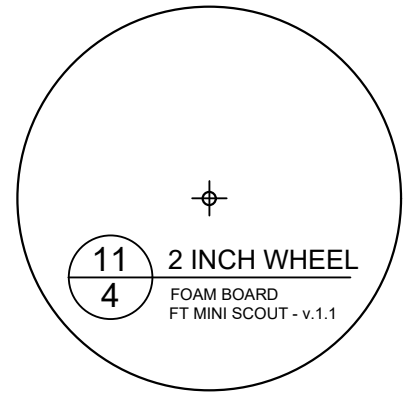

2
1 RIGHT WING PANEL
FOAM BOARD
FT MINI SCOUT - v.1.1



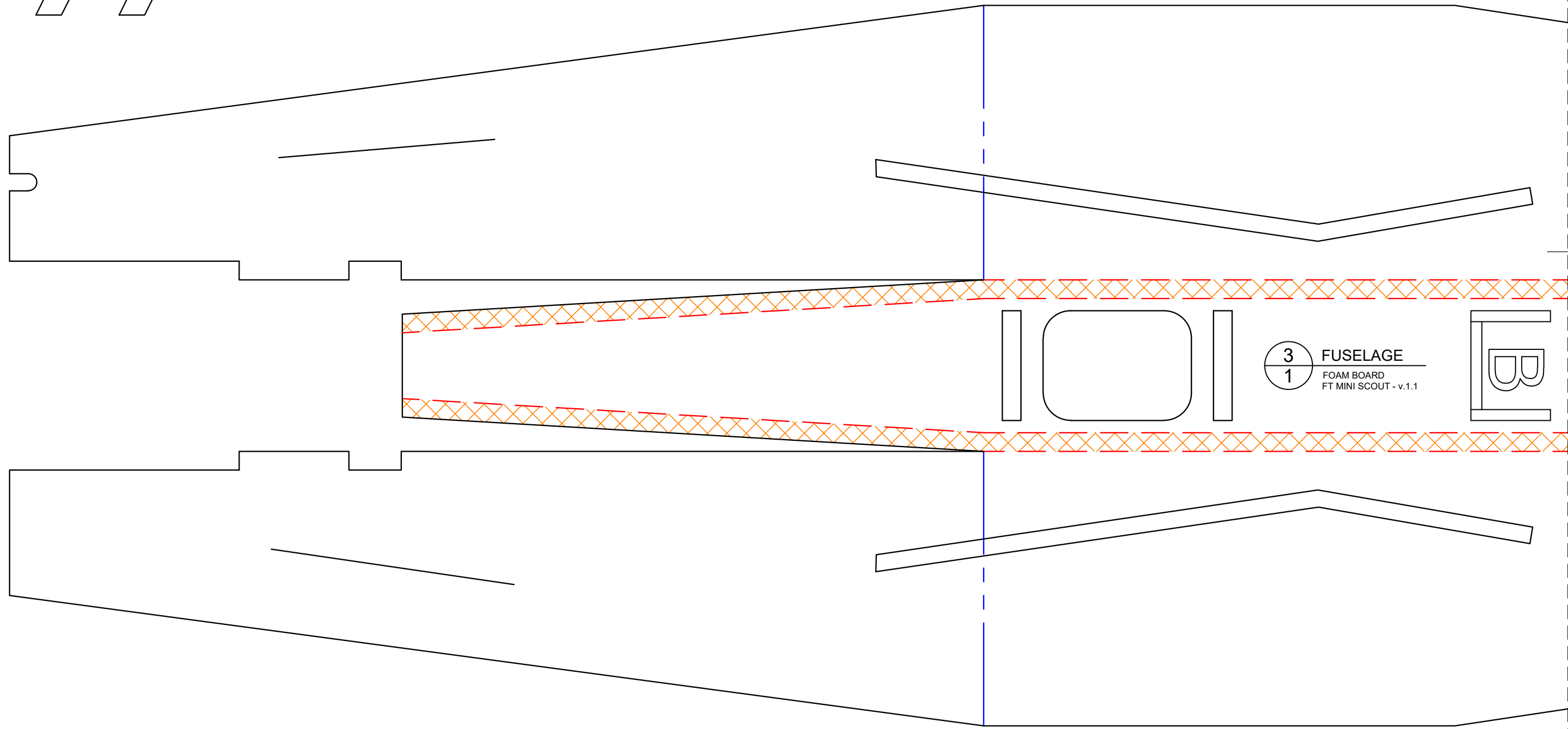
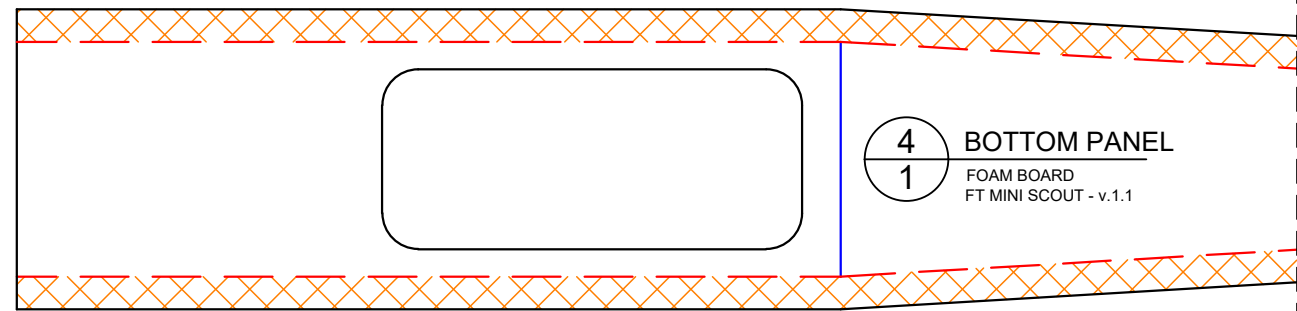
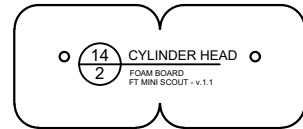
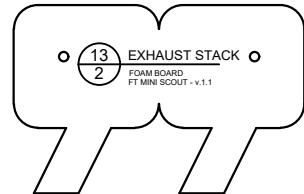
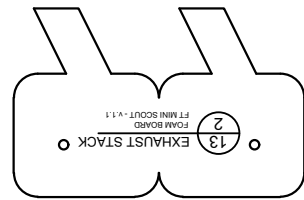

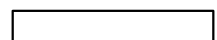
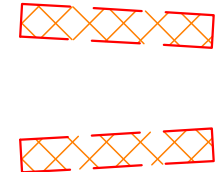
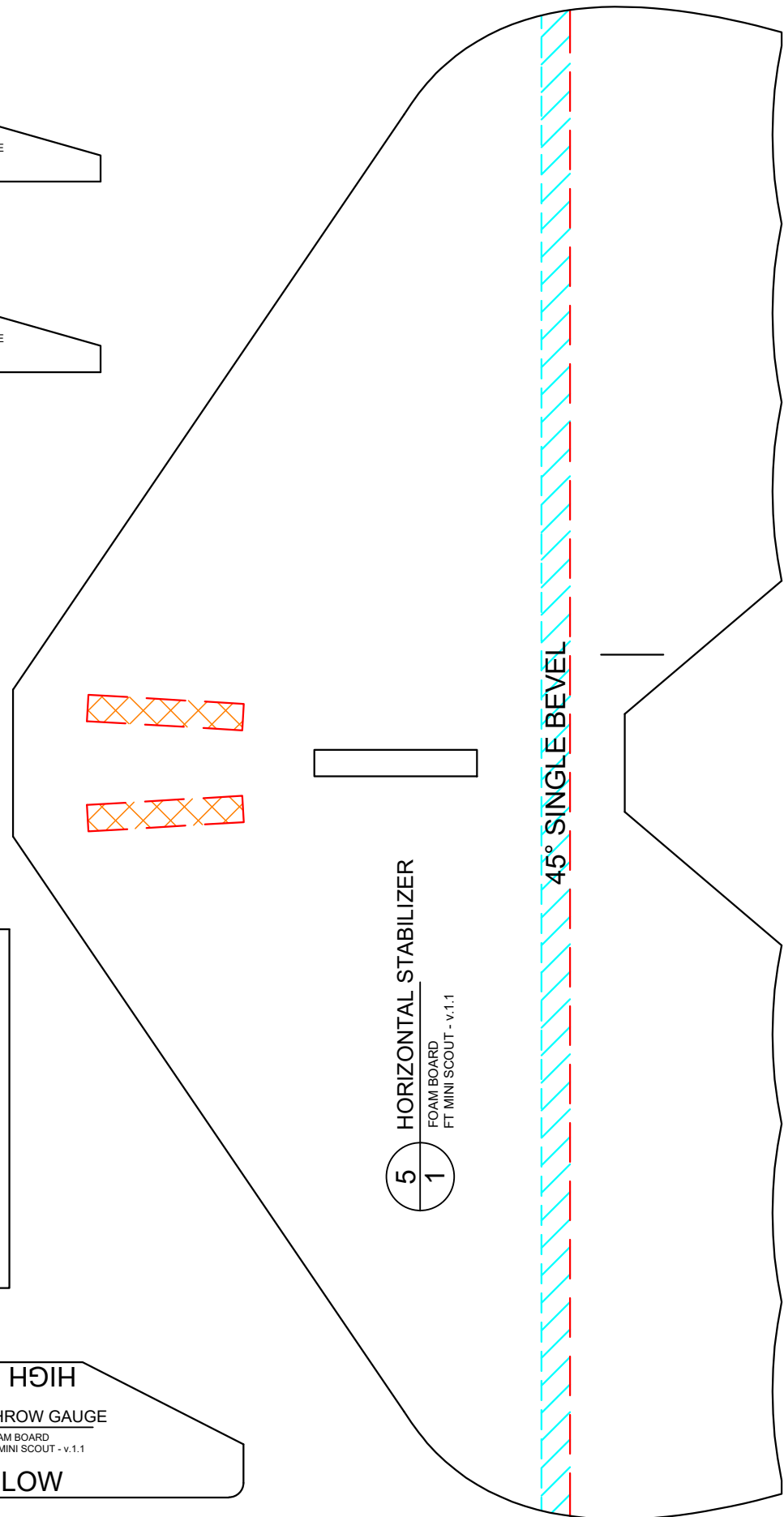
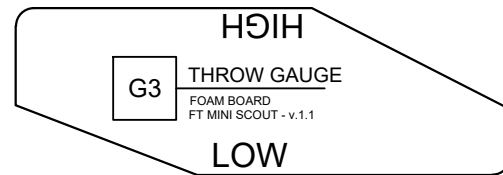
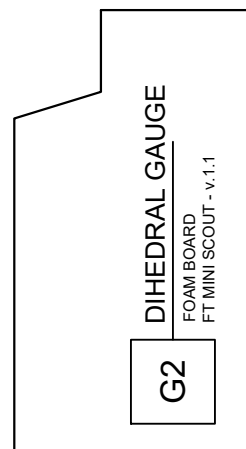
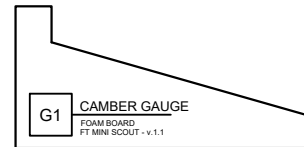
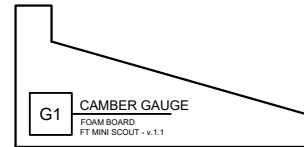
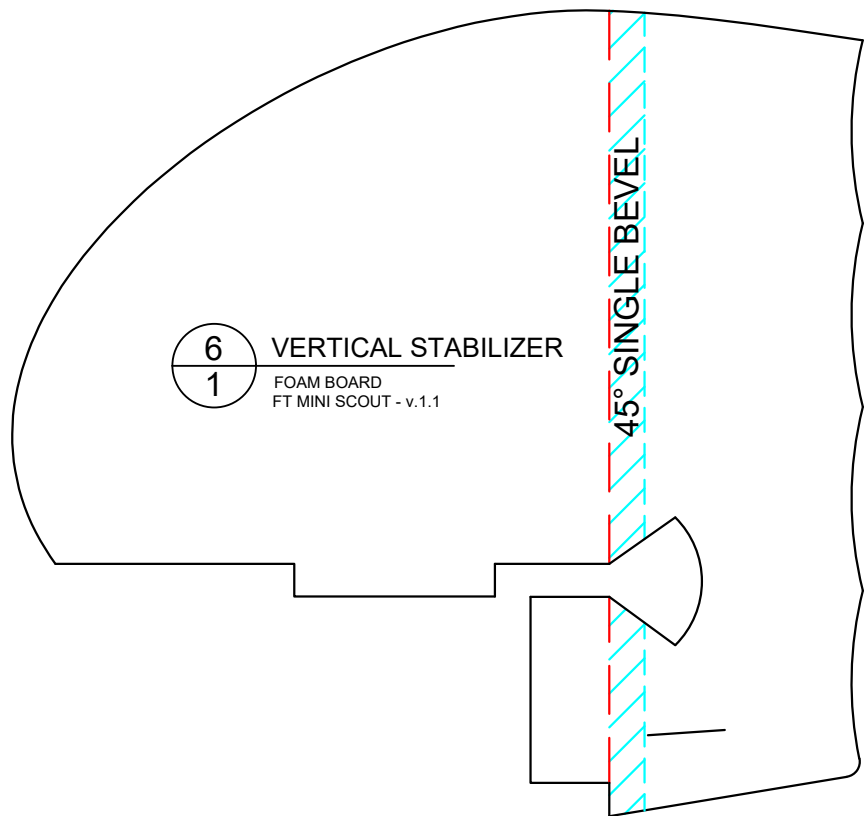
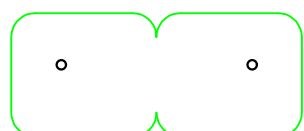
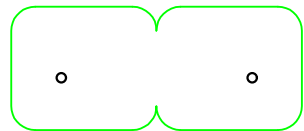
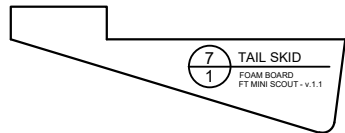
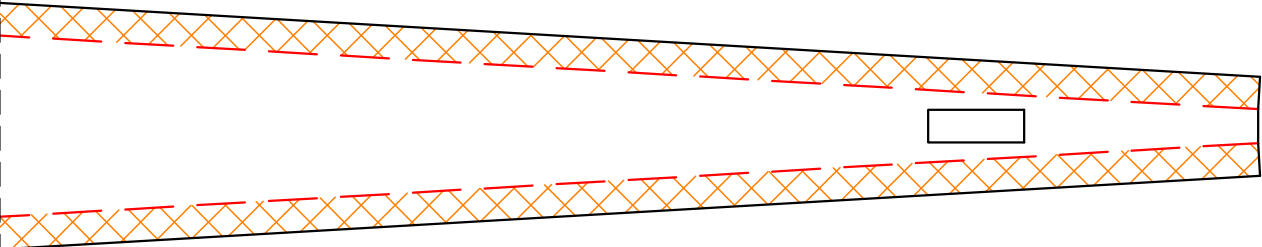

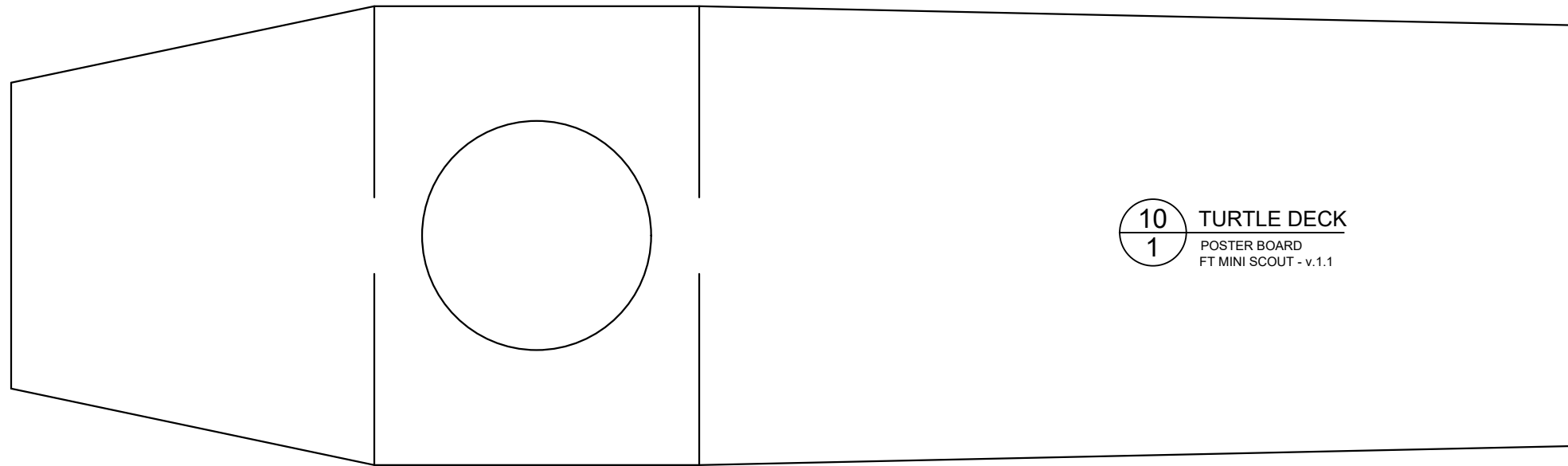

10 / **1** **TURTLE DECK**
POSTER BOARD
FT MINI SCOUT - v.1.1

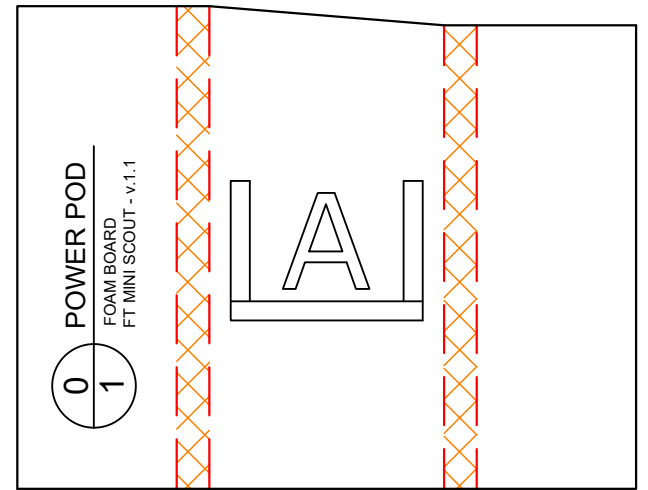

0 / **1** **POWER POD**
FOAM BOARD
FT MINI SCOUT - v.1.1

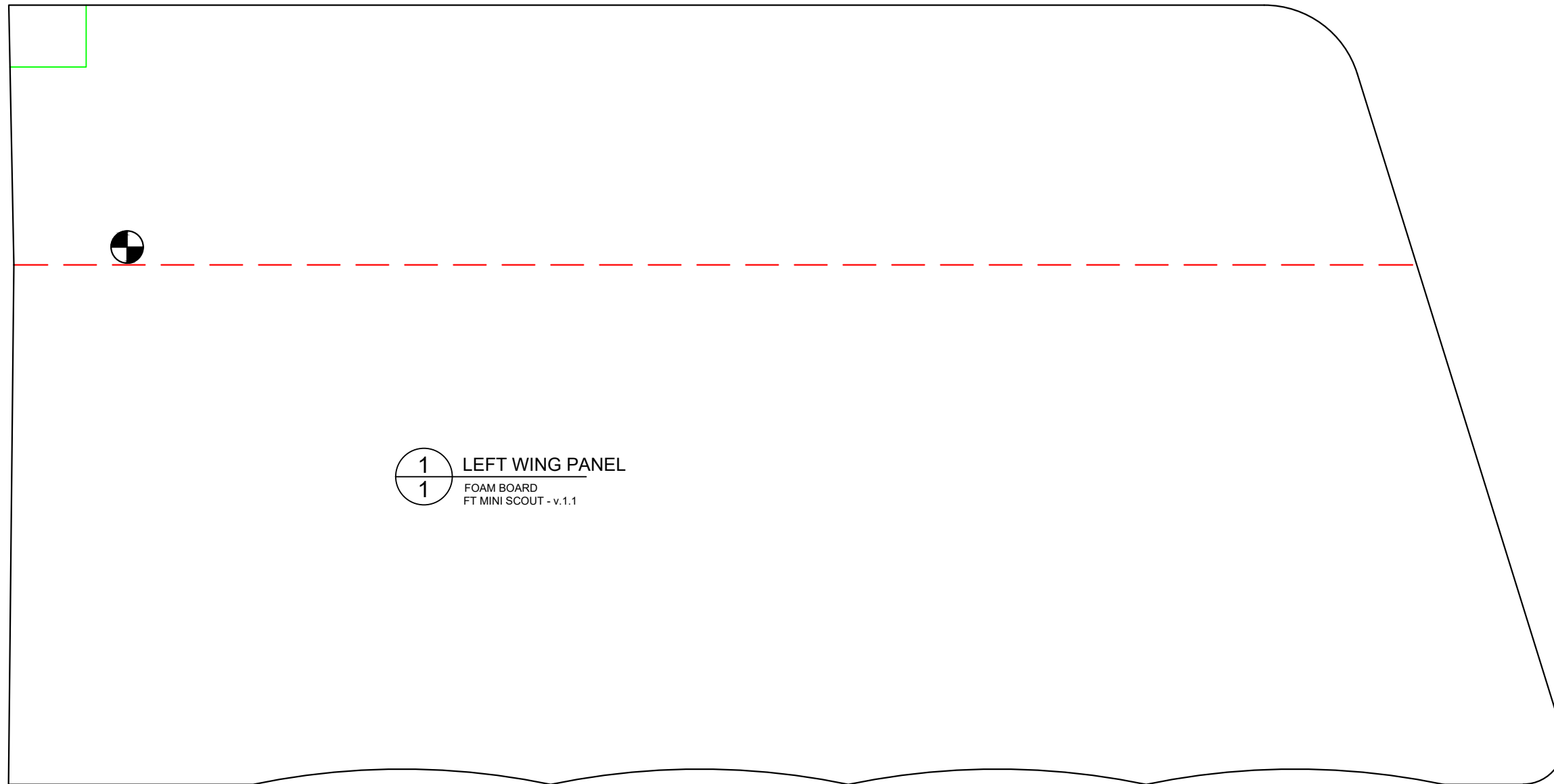

1 / **1** **LEFT WING PANEL**
FOAM BOARD
FT MINI SCOUT - v.1.1

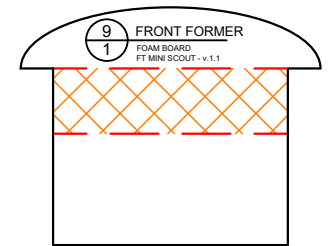

9 / **1** **FRONT FORMER**
FOAM BOARD
FT MINI SCOUT - v.1.1

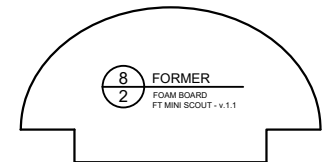

8 / **2** **FORMER**
FOAM BOARD
FT MINI SCOUT - v.1.1

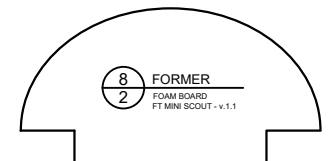

8 / **2** **FORMER**
FOAM BOARD
FT MINI SCOUT - v.1.1

FT MINI FIREWALL

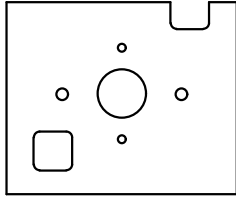

HOBBY GRADE PLYWOOD
1/16" (1.6 mm) THICK

FT MINI CONTROL HORN
2 REQUIRED



HOBBY GRADE PLYWOOD
1/16" (1.6 mm) THICK

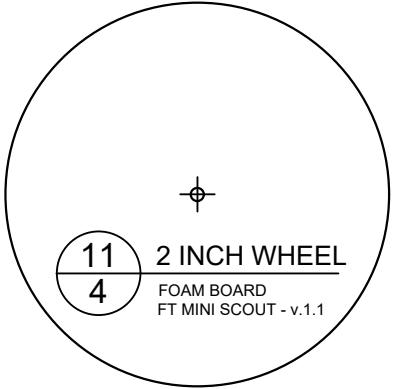

11
4 **2 INCH WHEEL**
FOAM BOARD
FT MINI SCOUT - v.1.1

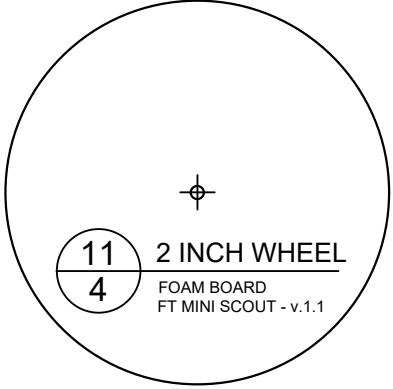

11
4 **2 INCH WHEEL**
FOAM BOARD
FT MINI SCOUT - v.1.1

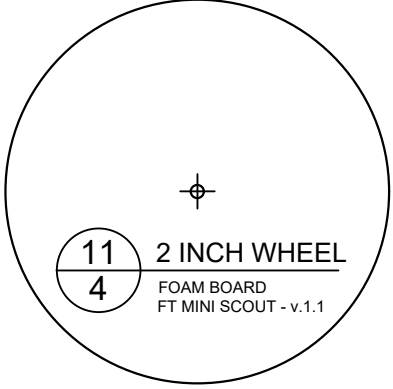

11
4 **2 INCH WHEEL**
FOAM BOARD
FT MINI SCOUT - v.1.1

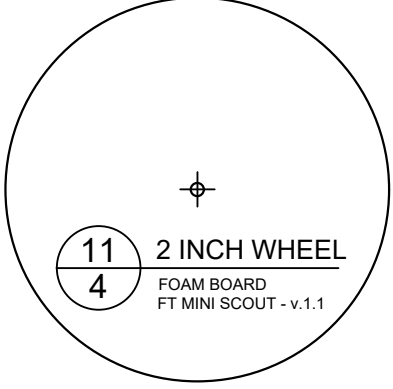

11
4 **2 INCH WHEEL**
FOAM BOARD
FT MINI SCOUT - v.1.1

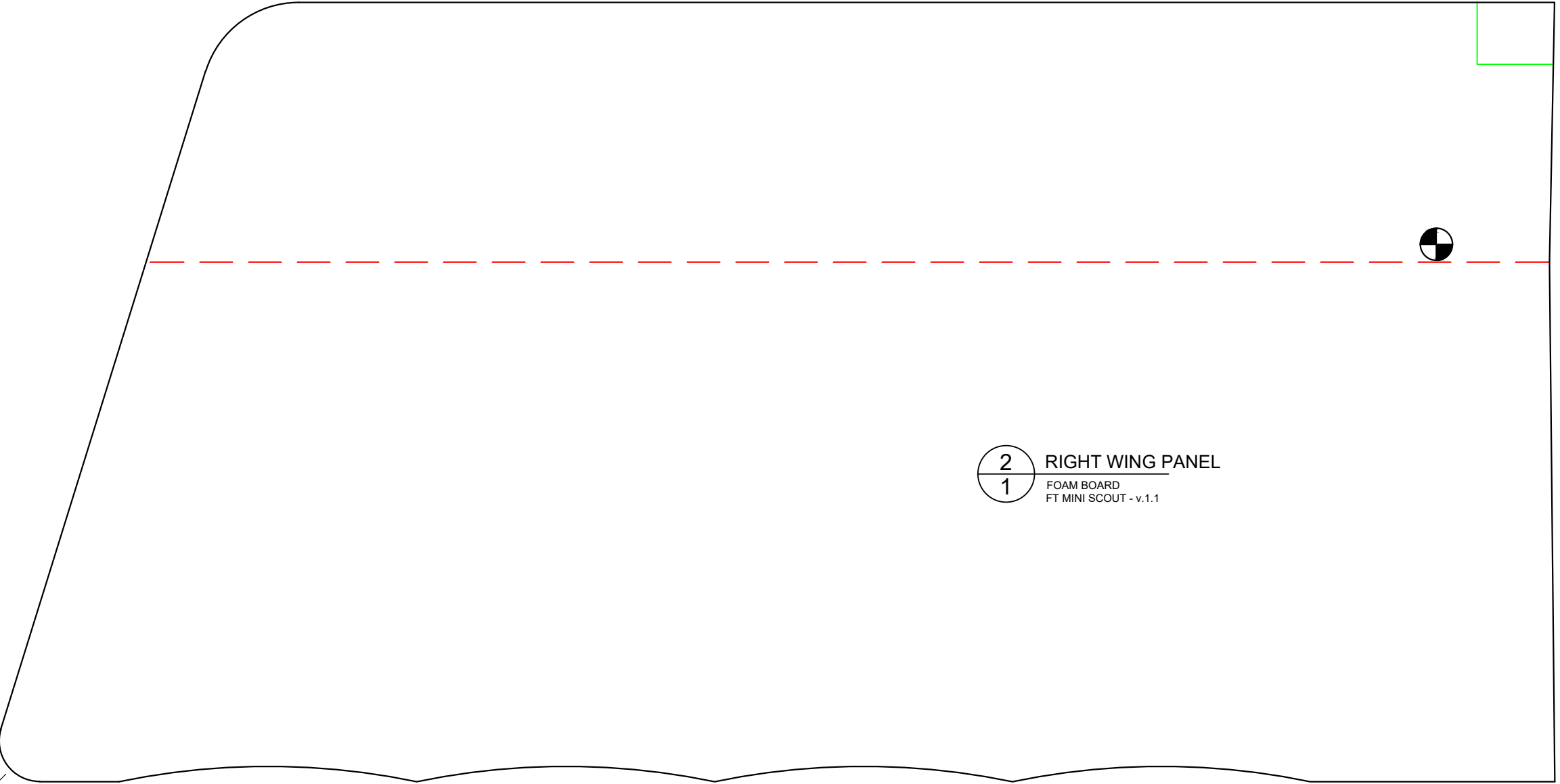

2
1 **RIGHT WING PANEL**
FOAM BOARD
FT MINI SCOUT - v.1.1