

# User Guide

rev. 2020/02

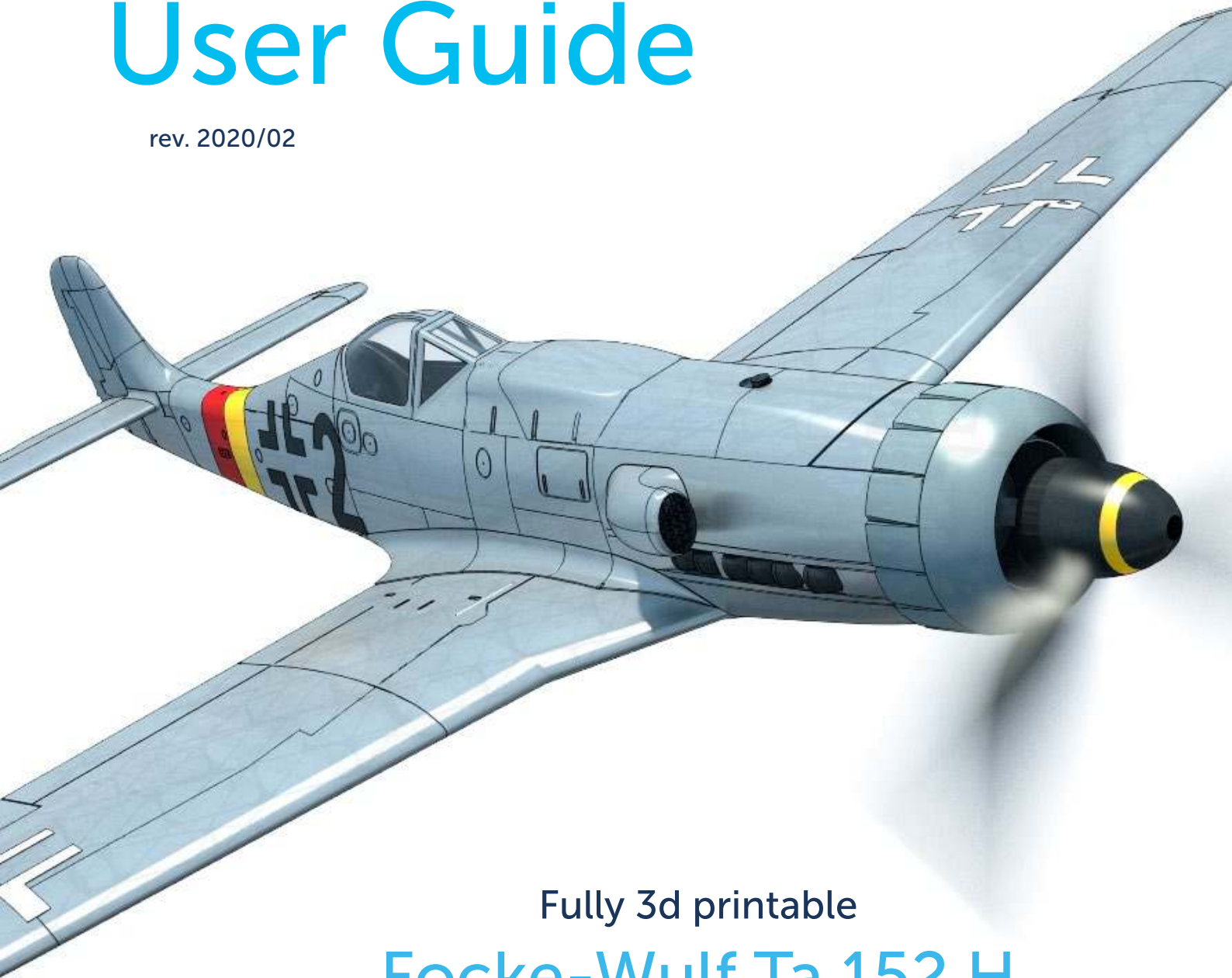

Fully 3d printable

## Focke-Wulf Ta 152 H

scale 1:12, wingspan 1236 mm / 48.2 inch

# Focke-Wulf Ta 152 H

– fully printable R/C plane for your desktop 3Dprinter

Future of flying - Print your own plane.

Fully 3D printable RC model of the "Höhenjäger" german attack plane, specially designed to meet ACES aircombat requirements, but also as a cheap and easy to build RC model for everyday flying. Many scale details such as armament, airframe plating or exhausts encourages to create realistic paint jobs. Huge wing area results in nice stall characteristics and easy landings. Get ready for battle with this great performing flying legend!

**The first fully printable** airplanes with files prepared for your 3Dprinter, with flight characteristics, comparable or even superior to classic build model airplane. This is not a dream, now you can print this HI-TECH at home. Simply download and print the whole plane or spare parts anytime you need just for a cost of filament only about \$18

**Extensive hi-tech 3d structural reinforcement** making the model very rigid while maintaining a lightweight airframe and exact airfoil even it's just a plastic. This perfect and exact 3d structure is possible only thanks to additive 3dprinting technology. So welcome to the 21st century of model flying and be the first at your airfield.

**Easy to assembly**, you don't need any extra tools or hardware, just glue printed parts together and make pushrods for control surfaces. The rest of the assembly is very easy. Simply add brushless motor, ESC, servos and radio system. Don't worry, detailed step by step PDF/VIDEO is included.

You'll get a superb performing airplane with highly efficient powerplant capable of flying 7+ minutes at full throttle and speeds exceeding 110 kph (HP setup). Low stall speed is achieved for easy landing on the other hand.

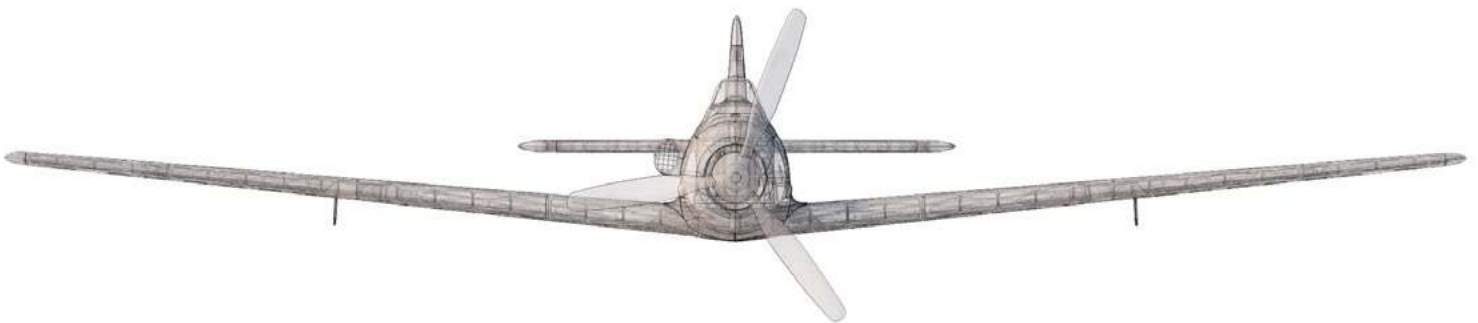

## General specifications (HP setup):

Wingspan:	1236 mm / 48.2 inch
Lenght:	870 mm / 33.9 inch
Height:	178 mm / 6.95 inch
Wing area:	21,4 dm <sup>2</sup> / 2.28 square foot
Wing loading:	46 g/dm <sup>2</sup> / 15.3 oz/square foot
Center of gravity:	60 mm / 2.34 inch from leading edge
Airfoil:	LHK508 modified by 3DLabPrint
Print weight:	624 g / 22.01 oz
Print weight of hybrid version:	490 g / 17.31 oz
Empty weight (w/o battery):	680-890 g / 24-31 oz
Takeoff weight (6s 1500 lipo):	810-1190 g / 28-42 oz
Max takeoff weight:	1300 g / 46 oz
Never exceed speed, VNE:	150 km/h / 93 mph
Design maneuvering speed, VA:	100 km/h / 62 mph
Stall speed, VS:	30 km/h / 18.6 mph



## Recommended setups

Motor:	EMAX MT 3510 600KV (for 6S setup) DYS D4215 650KV (for 6S setup) AX-4008Q 620KV (for 6S setup, motor is discontinued - use it from your old planes)
ESC:	<a href="#">YEP 40A/6S</a> or similar
Propeller:	two blade APC electro 10 x 5,5 or Aeronaut CAM Carbon Light 10 x 6
Battery:	Li-Pol 1500-1800mAh 6S1P Battery Pack printed PET motor mount with alluminium cross mount

More tested setups you can find at page 19.

## Performance measurement

Max speed VH (level flight):	105 km/h – 56.7kn – 65.2mph with APC 11x5,5
Rate of climb:	20 m/s (5 373 ft/min) with APC 11x5,5
Flight time (6s 1700mAh/full):	7:30 with APC 10x5,5

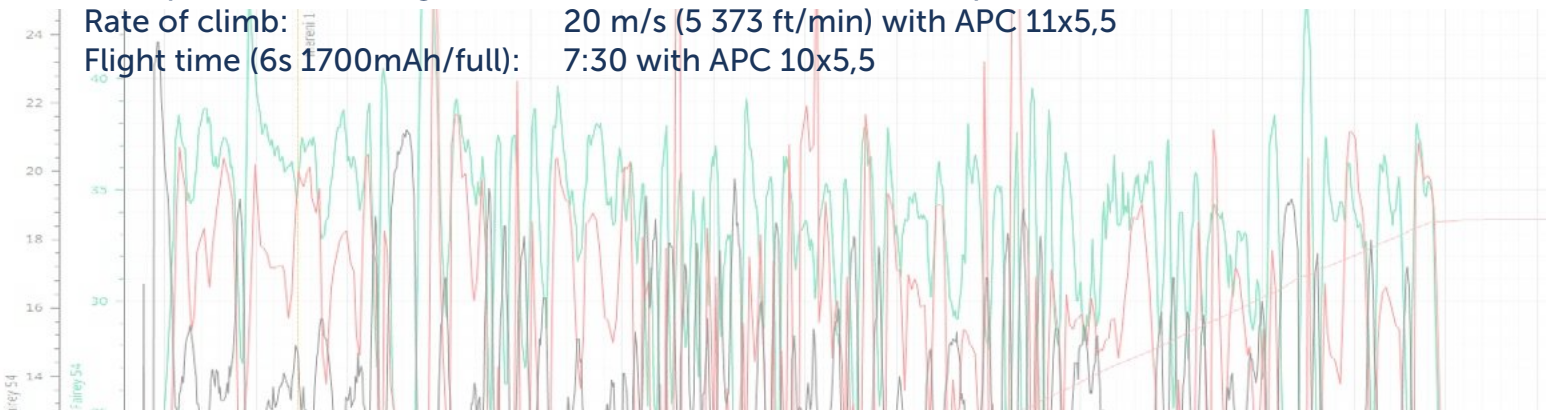



## Focke-Wulf Ta 152 H (Höhenjäger), History

The Focke-Wulf Ta 152 was a World War II German high-altitude fighter-interceptor designed by Kurt Tank and produced by Focke-Wulf.

The Ta 152 was a development of the Focke-Wulf Fw 190 aircraft. It was intended to be made in at least three versions: the Ta 152H Höhenjäger („high-altitude fighter“), the Ta 152C designed for medium-altitude operations and ground-attack using a Daimler-Benz DB 603 and smaller wings, and the Ta 152E fighter-reconnaissance aircraft with the engine of the H model and the wing of the C model.

The first Ta 152H entered service with the Luftwaffe in January 1945. The Ta 152 was produced too late and in insufficient numbers to affect the outcome of the war. Kurt Tank originally designed the Ta 152 using the Daimler-Benz DB 603 engine as it offered better high-altitude performance and also a greater developmental potential.

The Ta 152's fuselage was an extended version of the Fw 190D-9 fuselage with wider-chord fixed vertical tail surfaces. Due to the changes in the center of gravity and overall balance, the nose was also lengthened.

To reach higher altitudes, a pressurized cockpit was added to the H models. The H model had heavy armament to allow it to deal quickly with enemy aircraft. It had three weapons: one 30 mm (1.18 in) MK 108 Motorkanone cannon centered within the propeller hub and two 20 mm MG 151/20 cannons, synchronized to fire through the propeller, located in the wing roots.

The Ta 152H-1 was among the fastest piston-engined fighters of the war, with a top speed comparable to the twin-engined Dornier Do 335. It was capable of 755 kilometres per hour (469 mph) at 13,500 metres (44,300 ft) using the GM-1 nitrous oxide boost.

Kurt Tank was flying an unarmed Ta 152H in late 1944 to a meeting at the Focke-Wulf plant in Cottbus when ground controllers warned him of two P-51 Mustangs. The enemy aircraft appeared behind Tank, but he escaped by applying full power and engaging the MW 50 boost „until they were no more than two dots on the horizon“

## Included:

### 1. STL 3d files

Universal STL files designed to be used with desktop FMD 3d printers and slicer software as Simplify3D (recommended), CURA or MatterControl (these STLs are not compatible with Slic3r).

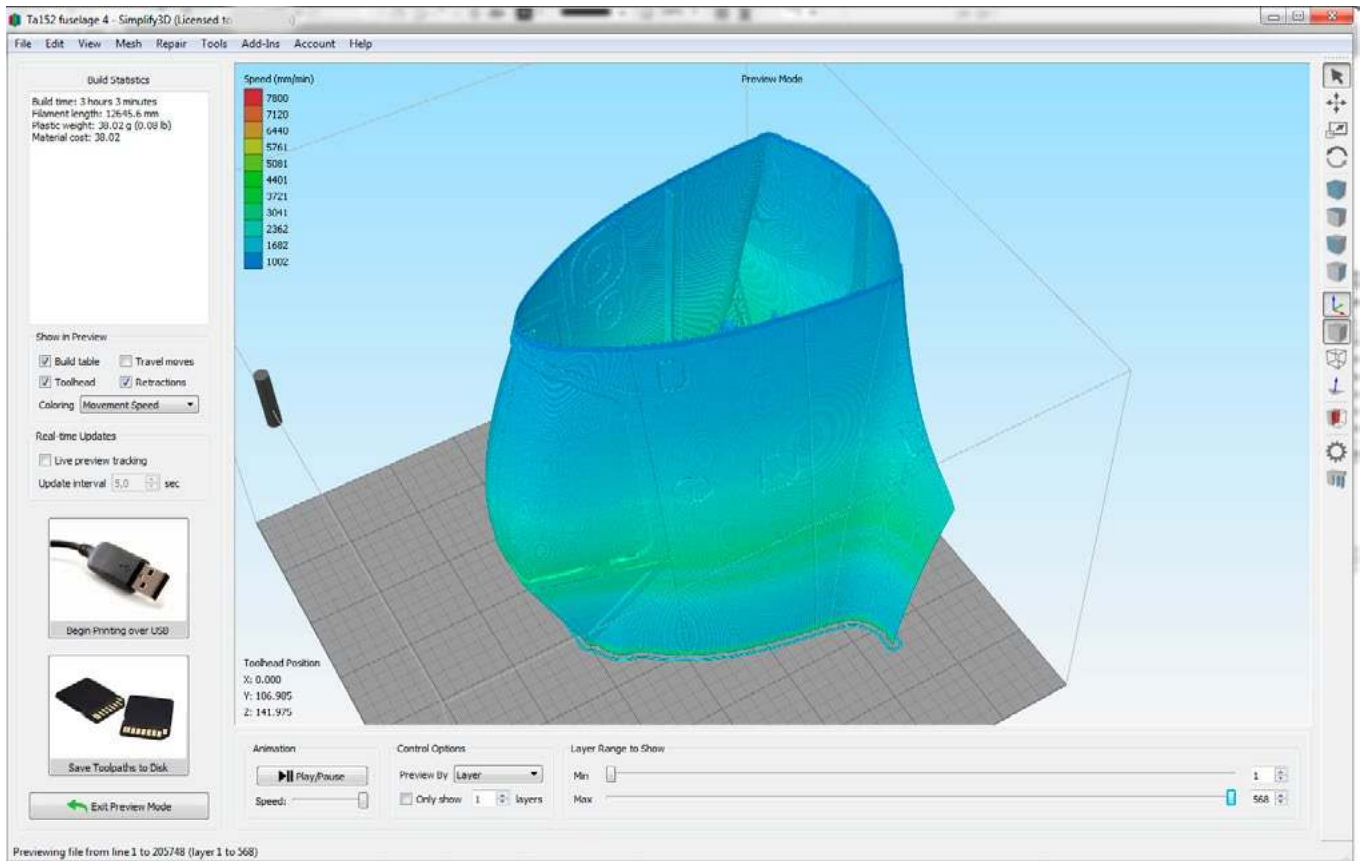

### 2. Factory files for Simplify3D slicer - preferred

contains all the necessary settings to slice the models along with suggested bed layout. We're using PRUSA i3 ORIGINAL printers so you may need to adjust the basic printing parameters to match your printer or use these files as a start point for you. Please check the [Simplify3D](#)

### 3. Step By Step PDF/VIDEO userguides

Apart from this userguide, please see the Printing Guide to find some Tips and Advice for airplane printing (Thin Wall Printing).

## 4. Gcodes

Basic Gcodes prepared for direct use, as universal as possible. Should work on i3 style printers, Give it a try, but we can't guarantee it will work on your printer. You can also easily adjust the retractions if necessary using our [guide](#). 100% compatible with PRUSA i3 ORIGINAL 3d printers.

## 5. Slice on your own with CURA or MatterControl slicers

If you for any reason don't like Simplify3D, there is always option to use another free slicer Please follow our [Cura guide](#) in the Help section of the website where you can find the basic single-wall profile.

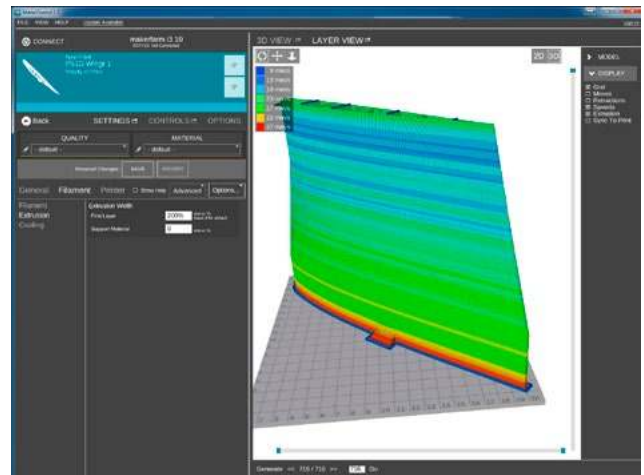
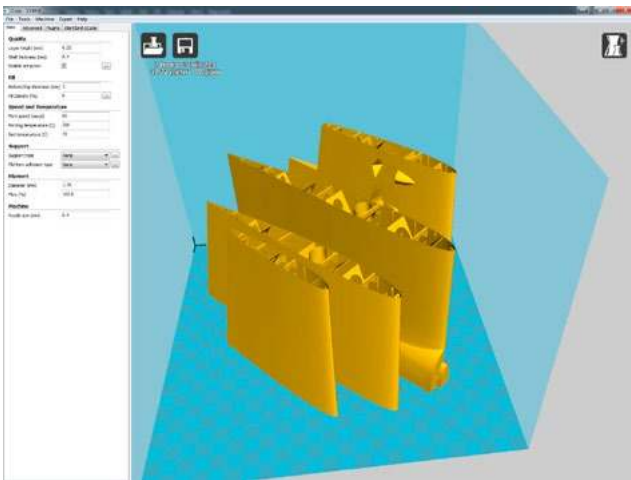

## 6. Scale markings PDF

You could cut this PDF in scale from thin self adhesive advertisement foil and place it on the model as needed. You can use cabin pattern for masking the canopy before painting.

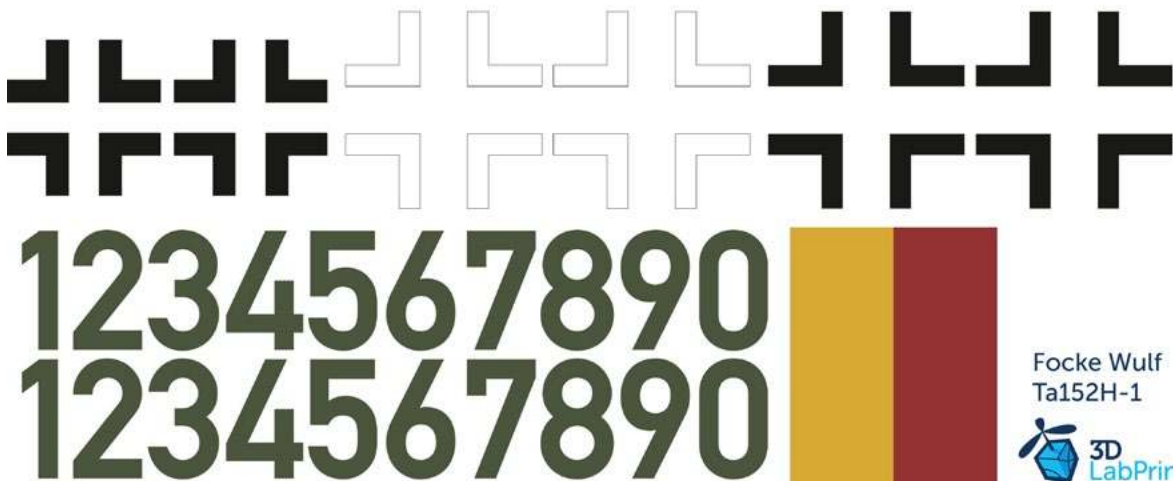
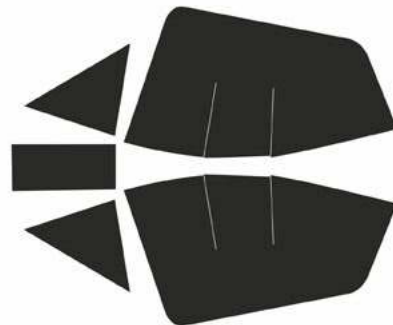

## Ta 152 H

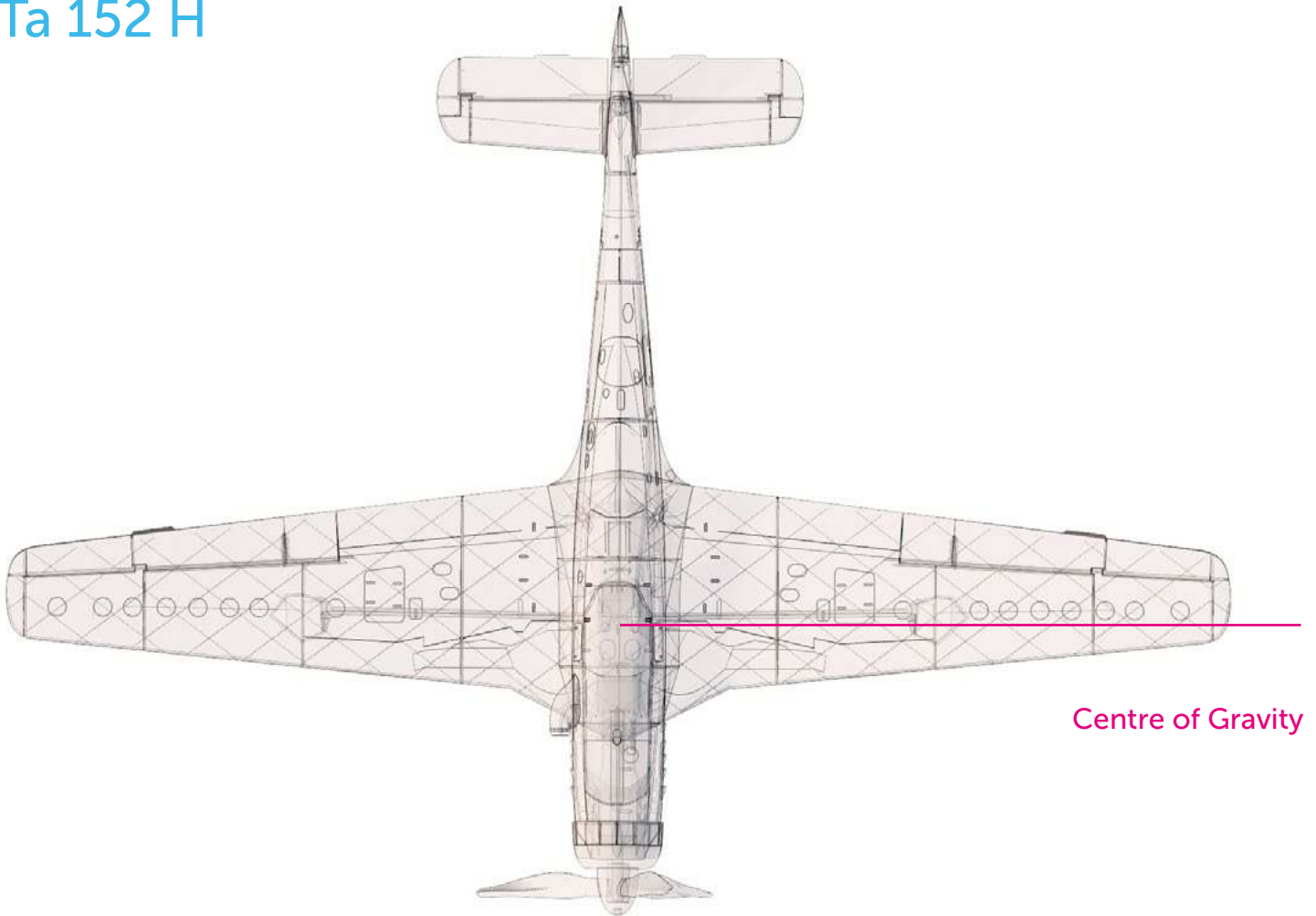

Wing area: 21,4 dm<sup>2</sup> / 2.28 square foot

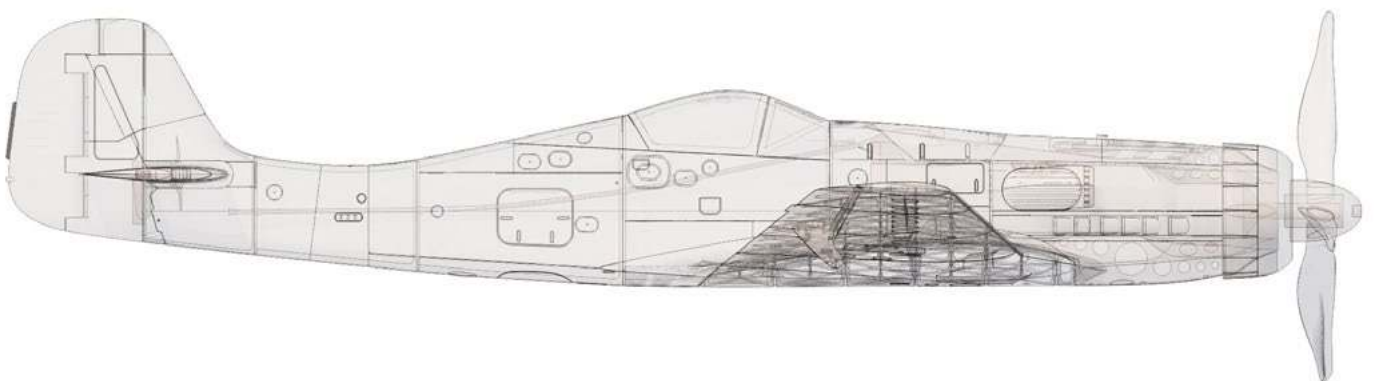

Length: 870 mm / 33.9 inch

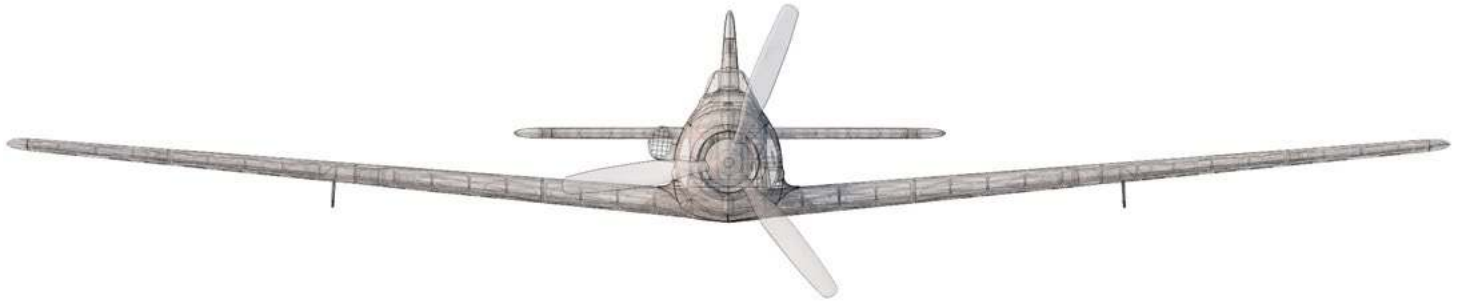

Wing span: 1236 mm / 48.2 inch





## Step By Step PDF/VIDEO userguide

1. Choose airplane at [www.3DLabprint.com](http://www.3DLabprint.com), visit our [Facebook](#) for latest info.



**Basic requirments for Ta 152 H are 195/195/175mm volume,** nozzle 0.4mm recommended (0.35 or 0.5mm alternatively). Heated bed recommended.

PLA filament (or PETG, APLA, htPLA, PC-max....) not ABS.

Contact: [support@3dlabprint.com](mailto:support@3dlabprint.com)

## 2. Create account, download

You will receive download link to all the zipped files to your email (please check your spam folder if not) or you can log in to your account and download directly from our websites.

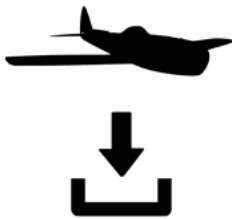

## 3. Gcodes preparing

option A Gcodes:

if your printer is i3 comptabile you can use [prepared gcodes](#) directly. Just save them to the SD card and let the 3d printer do it's job. HE temperature is set to 230°C so the layers fuse together well, you can adjust speed and temperature only through your printer's LCD. If these Gcodes does not work for you, please proceed to the next options.

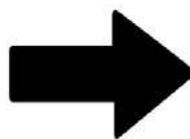
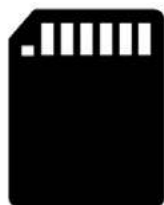

### option B Factory files Simplify3D (recommended):

We prepared all you need in these files (FFF process settings, parts layout on bed, etc...) You can use these settings as a start point. Adjust according to your need (adapt for your printer), print single parts and so on... Most 3d printers should work just with these settings, but please go through the settings and amend if necessary, we are not liable for any damage resulting from using our settings. If this still does not work for you, please proceed to the next option.

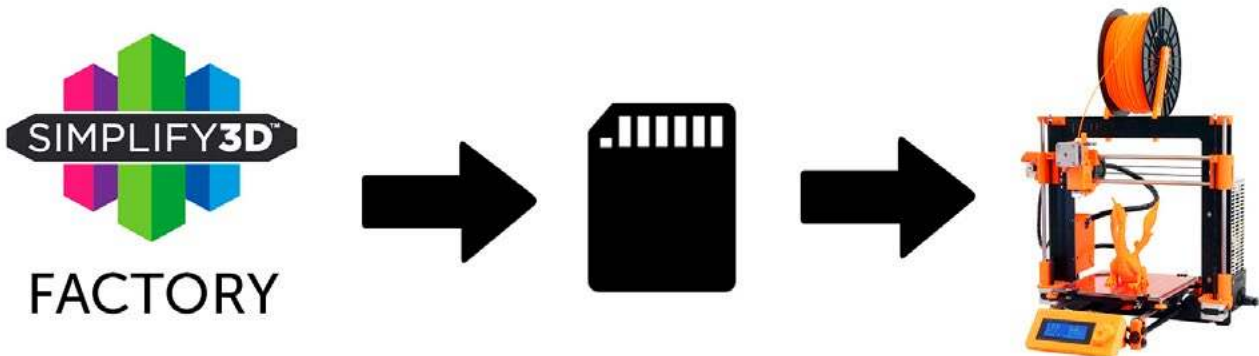

### option C Simplify3D manual setting (watch and learn):

Use our [video guide 2](#) and check our [Simplify3D reference guide](#) for proper setting... this is very good option and you will learn a lot about Simplify3D and become an 3d printing expert. Of course you spend a lot of time and youtube pause button will become your friend.

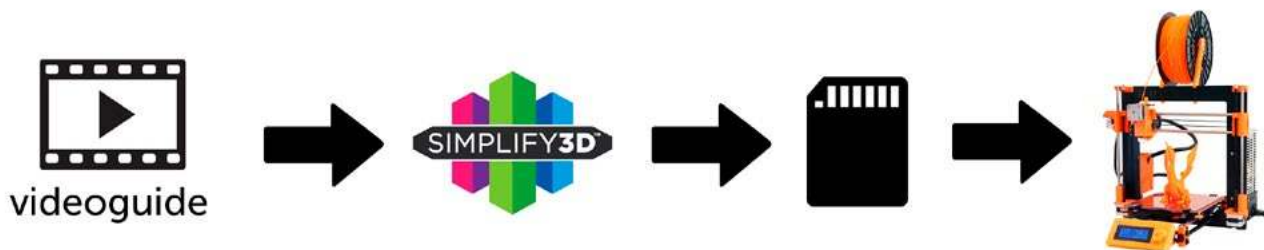

AND... please watch our VideoGuides:

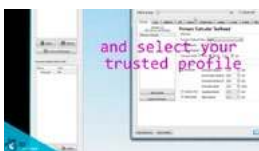

[video 2](#) Simplify3D setting

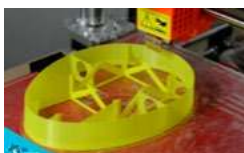

[video](#) about Thin Wall Printing

### option D CURA or MatterControl

MatterControl and CURA are free and provide satisfactory results. The airframe is still strong enough, but don't expect the best quality. Both slicers lacks some very useful features, and finer settings, like multiple processes according to Z height, retraction options, layer start, etc.

Please try to find the best extrusion multiplier and temperature for good weight and best possible layer bonding. Look at parts weight list for proper multiplier settings.

As a starting point you can use our predefined CURA or MC slicer setting file - see below (always adapt it for your printer, change build volume, filament diameter, etc...

according to your printer!!!)

Please check our [CURA guide](#) on the website for the latest basic profile. Please visualise our presliced gcodes to see how the result should look like and try to achieve the same in your slicer.

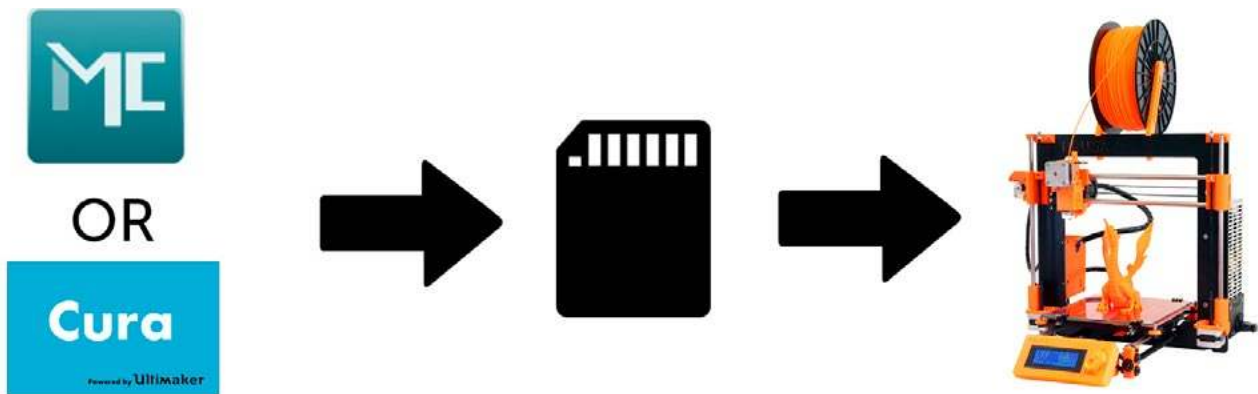

Please watch our [VideoGuides...](#)

## 4. Print it

Save the Gcodes to the SD card and insert into your printer. Prepare your printer and start printing, we prefer to use SD card rather than direct USB connection. Note: ABS filament is not suitable for thin wall printing. Scaling the model will lead to unusable result!

### [Video guide about printing](#)

you will need: PLA filament - good quality and strong PLA (we need strong layer bonding)  
3DLac, Strong hair spray, or your favorite adhesive bed surface  
Razor blade

AND... please watch our VideoGuides:

### [video printing guide](#)



## Basic Tips and Advice

Please Experiment with your extrusion multiplier.

Also HotEnd temperature is very important for strong result, please try increasing the temperature to find the best value (200° up to 260° celsius).

Turn OFF cooling fan for better layer adhesion (HE fan should be ON). We dont need it for thin wall printing. We tried many different materials and despite it's lower thermal resistance the PLA is still our best choice.

Feel free to experiment with PETG, PC-max by Polymaker looks promising.

Heated bed is very recommended, 60-70° Celsius (to prevent warping ends).

Looks like any standard quality PLA is good for our planes, but the combination of PLA vs. Extruder vs. HotEnd is what matters the most.

We find some filament colors could have lower layer adhesion and lighter colors doesn't heat so much on the direct sunlight.

Many 3dprinters are on todays market, most of them are capable of printing our airplanes (specific thin wall printing...) sufficient volume, heated bed, 0.4mm nozzle.

## Please see the Printing Guide (FAQ):



## Print it lighter!

You could make your plane lighter than usual. There is a new foaming filament LW-PLA by ColorFabb. We were testing it a half year and we can recommend it for all nonstress parts. The LW-PLA filament using an active foaming technology to achieve lightweight, low density PLA parts. At around 230°C this material will start foaming, increasing its volume by nearly 3 times.

We can recommend you our hybrid version with some parts from LW-PLA. Of course Ta 152 H can be printed whole from normal PLA but you can improve your skill and plane by new material.

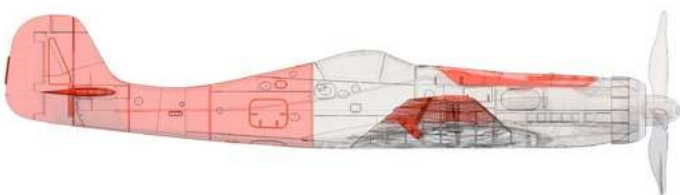
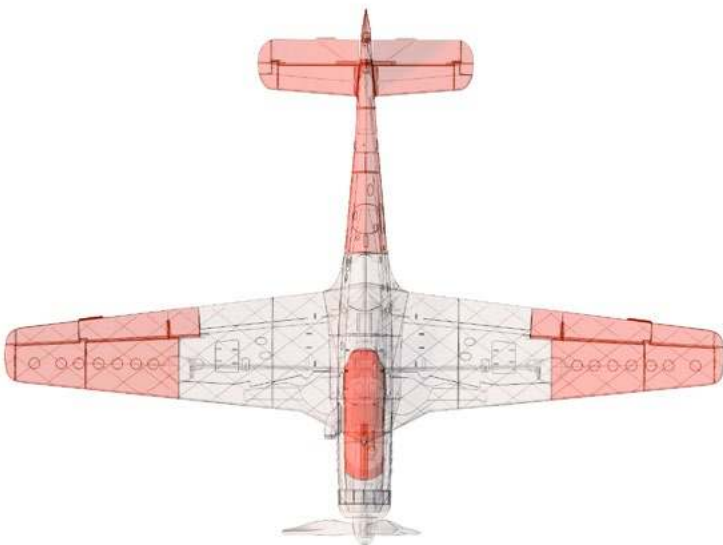

Red colored parts can be printed from LW-PLA for maximum flying performance.

## 3DLabPrint Ta 152 H weights of printed parts

	PLA	LW-PLA
<i>fuselage</i>		
F1	11 g	5,5 g
F2	49,6 g	25 g
F3	32 g	16 g
F4	39 g	20 g
F5	25 g	12,4 g
F6	14,6 g	7,3 g
F7	13,5 g	6,8 g
fuselage cover	21 g	10,4 g
fuselage cover arm	2,8 g	1,4 g
fuselage cowl	10 g	5 g
<i>wing</i>		
W1 (pair)	114 g	57 g
W2 (pair)	84 g	42 g
W3 (pair)	49 g	24,5 g
W4 (pair)	28 g	14 g
W5 (pair)	4 g	2 g
aileron (pair)	46 g	23 g
servo cover 2x	3 g	1,7 g
<i>tail</i>		
stabiliser (pair)	22 g	11 g
elevator (pair)	22,8 g	11,4 g
elevator arm	2,7 g	
rudder	14,6 g	7,3 g
<i>accessories</i>		
engine	3,2 g	1,6 g
compressor inlet		
motor mount	12,4 g	---
standard version	624,2 g	
hybrid version		490,9 g
super light version (theoretical)		320,4 g

## How to print LW-PLA?

The basic print setup is almost the same as we use for standard PLA. The only difference is in extrusion multiplier set to 0.5 and turning off the retractions completely.

This results in parts with half the weight and still suitable mechanical properties, but expect some heavy stringing inside and outside. Of course you can try to tweak the retractions for less stringing inside the parts, but there's a high risk of clogging the nozzle or throat. Increasing the retraction distance above 1 mm is not recommended at all and leads to nozzle clogs caused by foaming. Cleaning the hairy, but functional parts after printing with retractions completely disabled seems to be more efficient method. The nozzle is permanently pressurized and you don't need to worry about print failures. This method works fine even for bowden printers.

Extrusion multiplier 0,5 has been tested for easy print with massive weight saving around 50%. Feel free to experiment with extrusion multiplier and temperatures at will for the best results on your printer.

Cosmetic issues of the prints are easily fixed with snap knife or sand paper, as the LW is easily sanded and cut.

[Official guide by ColorFab - How to print LW-PLA](#)

## [Video of print LW-PLA](#)

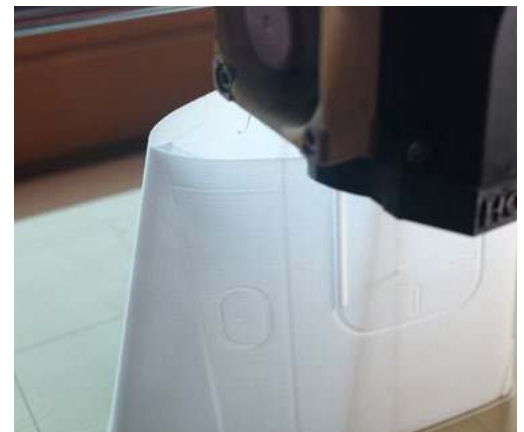
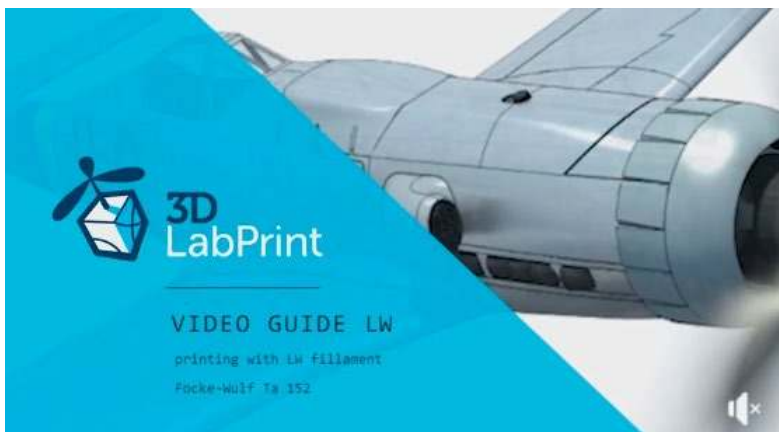

colorFabb B.V.  
The Netherlands

LW-PLA  
shop:

[https://colorfabb.com/  
lw-pla-natural](https://colorfabb.com/lw-pla-natural)

email sales:  
[sales@colorfabb.com](mailto:sales@colorfabb.com)  
email support:  
[support@colorfabb.com](mailto:support@colorfabb.com)

## 5. Assembly of printed parts

### 5.1 Wing assembly Ta 152 H

Glue wing parts L1-L6 perfectly together. The new 3D LabPrint lock system will help you. Repeat for the right side. Glue both halves of the wing together. Use the CA glue, (position locks and pins will help you to align the parts), and use activator to speed up the glue curing. On a flat surface glue the ailerons L1-L3 and repeat for the right side. Use a suitable 0,8mm - 1,2mm carbon rod or wire as a hinge for the ailerons. Just slide it in, there's no need to glue the hinge for easy aileron or servo replacement.

[See video guide #4](#)

you will need: CA Glue medium viscosity+ activator  
 0,8 - 1,2 mm carbon or steel wire for aileron hinge  
 Snap knife, Some cloth for wiping CA glue...

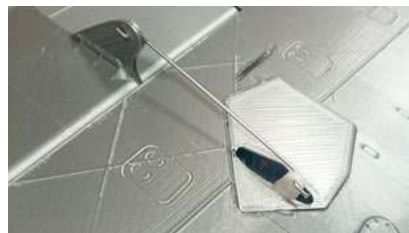
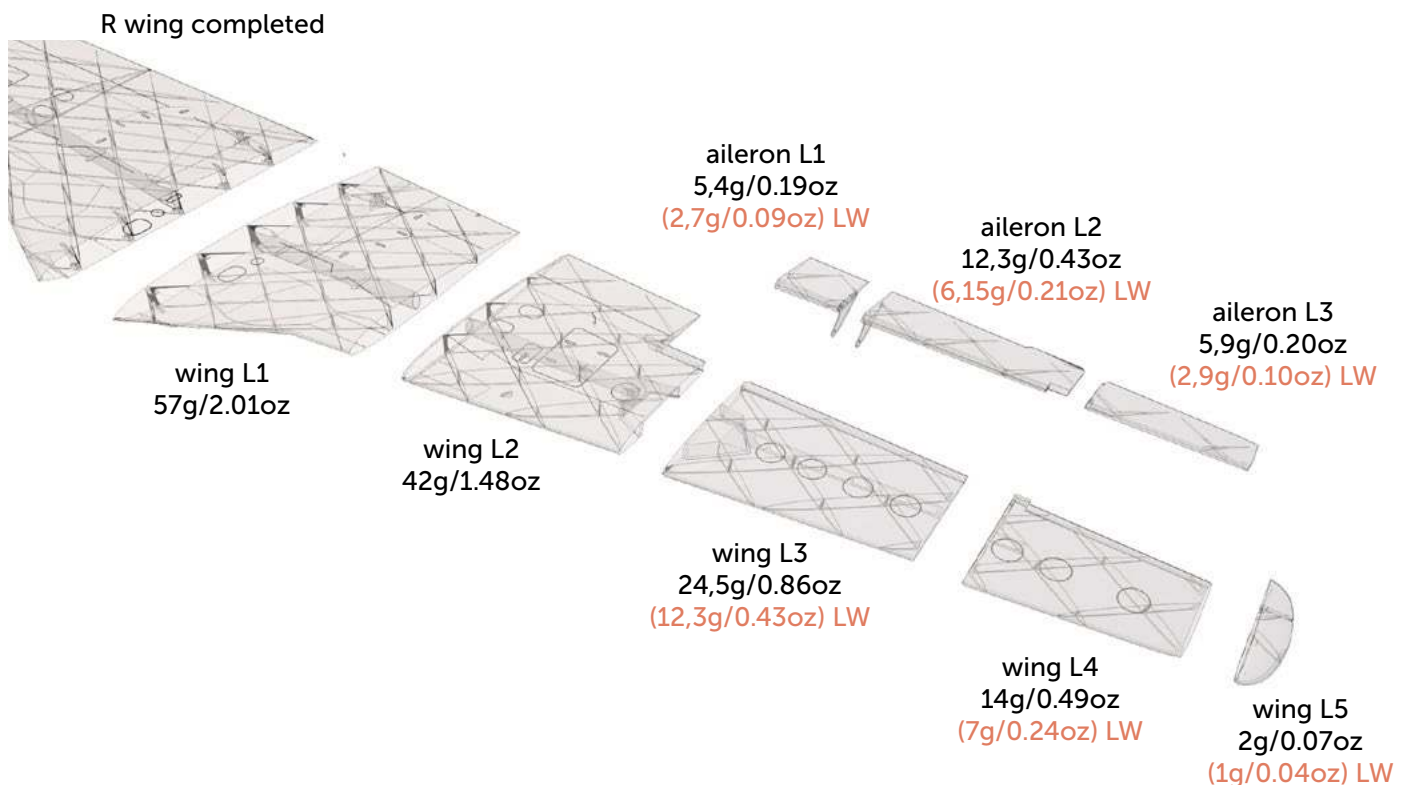

## 5.2.1 Fuselage assembly Ta 152 H

Glue fuselage parts with CA glue together (position locks and pins will help you) use activator. You can use snap knife for clearing the shape of printed parts, but mostly it is not necessary. Glue F1-F7 fuselage parts. Do not glue rudder part before tail and elevator assembly. Use any hot tool to remove the unnecessary material from F7 tail part.

Parts F4 and F2 can be printed in ACES version for fixing the wing assembly with rubber bands. If you prefer to use rigid mounting for wing, use two M5 nuts in prepared slots in F4 part and use bolts to fix the wing to the fuselage. Use hot glue for fixing the nuts in the slots. For fuselage cover arm use a ball pen spring. Put it to the part 2 and glue with part 1 together. You can glue engine compressor inlet as optional part too.

**NOTE: Don't glue the rudder tailpart yet !!! (proceed to the next step for elevator and stabilizer assembly)**

[See video guide #5](#)

you will need: CA Glue medium viscosity+ activator  
 Snap knife or Sandpaper, Soldering Iron or any hot tool + hot glue  
 2x M5 nuts  
 2x M5 Nylon Screws (you don't need it if you'll use a rubbers for the wing)

rudder  
 14,6g/0.51oz  
 (7,3g/0.25oz) LW

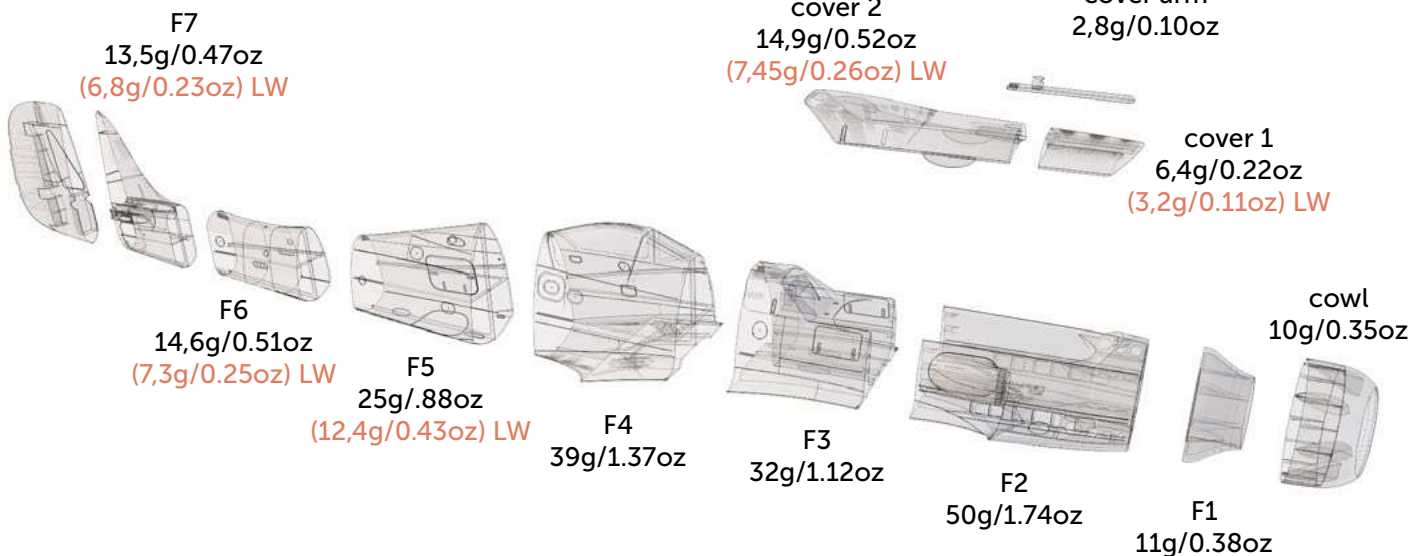

ball pen spring



M5 screw and nut for wing



F2 & F4 for rubber banded wings





## 5.2.2 Fuselage tail - elevator pushrods and servos

Glue L1 and L2 parts of the stabilizer and elevator. The profile is symmetric, so the left and right sides are identical. Glue the stabilizers perfectly perpendicular to the fuselage. Assemble both sides of the elevator with the control lever on a flat surface. Make a Z bend on the elevator 0,8mm pushrod wire. Using hot tool cut loose the hinge of the elevator on the F7 part of the fuselage and mount the elevator assembly to the stabilizer using the 0,8 - 1,2 mm carbon rod or steel wire. Elevator should move freely controlled by the pushrod and servo. Check the functionality of the elevator assembly carefully and finally glue in the rear rudder part.

you will need:

- CA Glue medium viscosity+ activator
- 0,8 - 1 mm steel wire for elevator pushrod
- 0,8 - 1 mm carbon or steel wire for aileron hinge
- Snap knife, Soldering Iron or any hot tool

[See video guide #5](#)

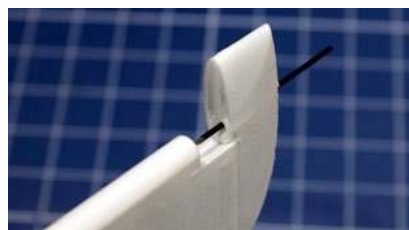
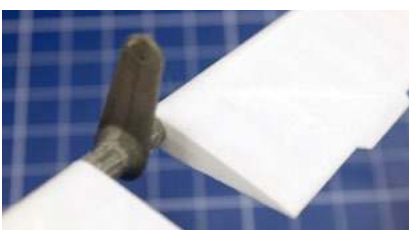
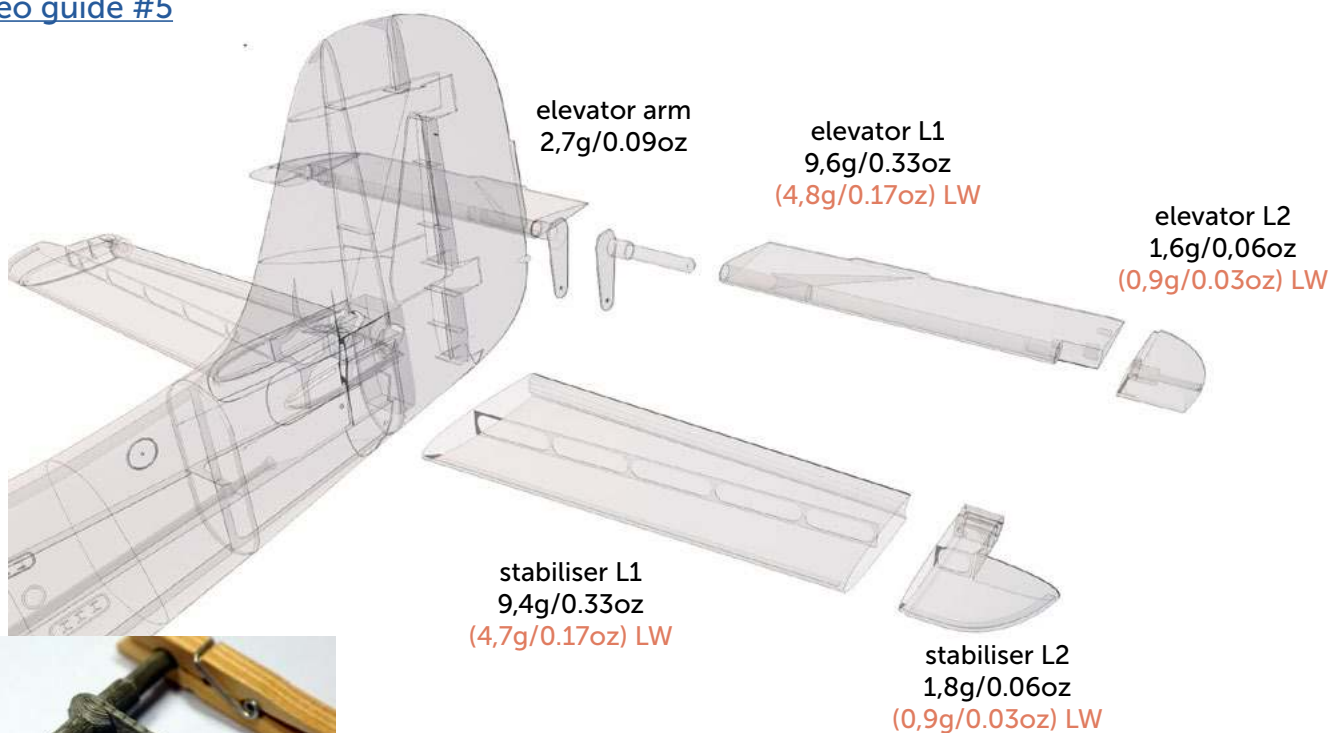

## 6. Servo installation

Extend the servo leads and install the prepared servos to wing servo bays. Use a 1mm steel wire with Z bends as a linkage between the servos and aileron control horns. Glue servo covers to the wing. Elevator servo will be fixed by servo holder in the fuselage.

[See video guide #6](#)

you will need:      3x [Hitec HS-82MG](#) or [Corona CS-238MG](#)  
                                  or any similar sized servos  
                                  30x12x30mm (1.17 x 0.47 x 1.16 inches)  
                                  2x 300mm servo extension  
                                  Snap knife, Z pliers

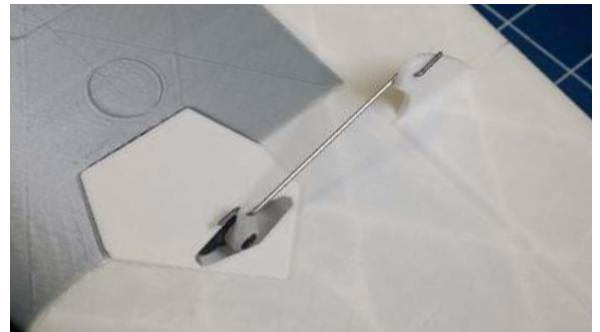
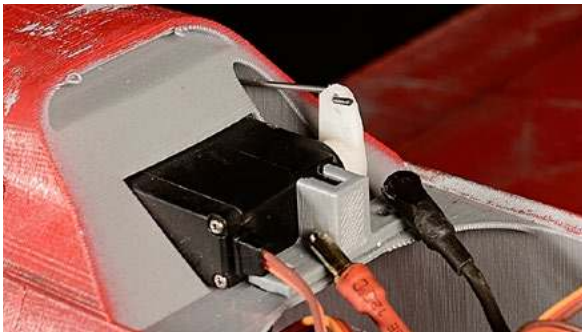

## 7. Motor & ESC & battery holder

Fix the battery using zipper ties to the battery holder and mount it in the front of the fuselage, find the perfect balance and CG position by moving it. Mount the motor on an alluminium cross using 4x M3 screws and nuts to the printed universal holder. You can also use the printed holder 16 x 19 mm from PET or anealed PLA. Glue universal motor mount with motor into the fuselage in right position.

[See video guide #7](#)

you will need:  
 4x M3 screws and nuts

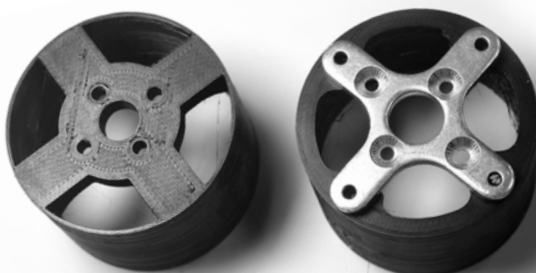

## Use power by your skill !

Our inovative motor holder can be used with various motors. Every motor should fit at universal printed holder with alluminium cross or 16 x 19 printed holder. Insert the complete assembly inside the slot in position you need and glue it .



### ACES performance setup - (530W)

Motor: DYS D4215 650KV (for 6S setup)  
 ESC: CastleCreation Talon 25A / 6S or similar  
 Propeller: two blade Aeronaut CAM Carbon Light 10 x 6 or APC Electro 10 x 5,5  
 Battery: Li-Pol TATTU GensAce 1800mAh 75C 6S1P Battery Pack  
 printed PET motor mount with alluminium cross mount



### OFFICER normal setup - (440W)

Motor: EMAX MT 3510 600KV (for 6S setup)  
 AX-4008Q 620KV (for 6S setup, motor is discontinued  
 - use it from your old planes)  
 ESC: [YEP 40A/6S](#) or CastleCreation Talon 25A / 6S or similar  
 Propeller: two blade APC electro 10 x 5,5 or Aeronaut CAM Carbon Light 10 x 6  
 Battery: Li-Pol 1500mAh 6S1P Battery Pack  
 printed PET motor mount with alluminium cross mount

### ROOKIE setup - (240W)

Motor: Leopard LC2830 980KV (for 3S setup)  
 ESC: [Turnigy 20A / 3S](#) or similar  
 Propeller: two blade GWS 9 x 7,5 (ugly orange)  
 Battery: [LiPol 1300mAh / 3s](#)  
 printed PLA mount 16 x 19 mm  
 (budget setup for LW hybrid version only)



## 8. Final assembly and setting

Refer to your R/C system userguide for setup information.

[See video guide #8](#)

you will need: Your own Rx/Tx system

Install your receiver, connect battery, setup servos and etc. with your transmitter, check servo position, then install propeller.

**Make sure the battery is positioned properly and secured with wing battery holder, if battery moves during flight it can shift the center of gravity backwards and aircraft will become uncontrollable! Never set ESC with propeller installed, this could be very dangerous!**

aileron

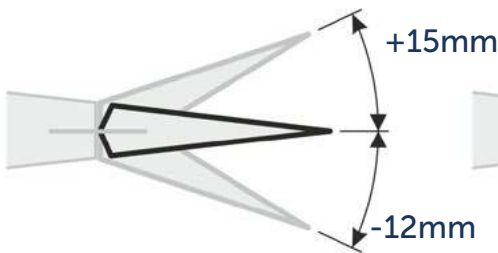

elevator

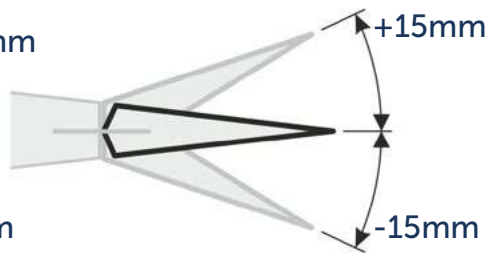

## 9. Go flying

Pre-flight check **center of gravity is very important** (move it 5-10mm forward for the first flights), battery properly charged, ailerons and elevator deflection check, your own flying skills or RC simulator training ...

[Fly video of Ta 152 H](#)



## 10. Pilots Please Attention!

For the first flights we recommend setting the center of gravity to around 5 mm forward of the CG tag - nose heavy, this increases the stability (you can use heavier battery). Increasing expo settings on your transmitter for elevator and ailerons to 80 % calms response from your stick inputs. Also you can decrease elevator and ailerons deflection to calm down the plane. Make sure the battery is well fixed in proper position. If it moves during flight it will cause shifting of CoG aft and will result in uncontrollable flight behavior.

After gaining some confidence you can balance the plane to the Center of Gravity marks and set Expos to 60 % as shown in the video/instructions... this gains back extra maneuverability.

**Never fly aft positioned Center of gravity.**

Please, use these files only for your own purpose, do not redistribute or publish. Thank you very much.

Enjoy your flight.



## Shopping list

Printing material:	0,65kg of PLA (150g of LW-PLA)
RC:	4 channel receiver for your RC system
Motor:	any motor for 3S - 6S Li-Pol with weight up to 100g  EMAX MT 3510 600KV (for 6S setup) DYS D4215 650KV (for 6S setup) AX-4008Q 620KV (for 6S setup, motor is discontinued - use it from your old planes) Leopard LC2830 980KV (for 3S setup)
Controller:	<a href="#">Speed controller (ESC) YEP 40A/6S</a> CastleCreation Talon 25A / 6S or similar
Battery:	6S Battery LiPol 1300-1800mAh/6s
Servos:	3x <a href="#">Hitec HS-82MG</a> or <a href="#">Corona CS-238MG</a> or any medium sized servos 30x12x30mm (1.17 x 0.47 x 1.16 inches)  2x servo extension cables 300mm / 12 inch
Glue:	CA Glue - medium viscosity Activator for CA Glue
Other:	1x 1 - 1,2 mm / 14 AWG pushrod wire or carbon rod 1x 0,8 mm pushrod wire 2x M5 fitting screws and nuts or rubber bands for wings 4x M3 screws and nuts