



Instruction Manual book

LANDSCAPE



SPECIFICATION

- Wingspan : 1,940 mm 76.38 inches.
- Length : 1,700 mm 66.93 inches.
- Weight : 5.8 kg 12.76 lbs.
- Radio : 6 channels.
- Servo : 8 servos.

- Glow Engine : 26 - 30cc gas.

Made in Vietnam.

This instruction manual is designed to help you build a great flying aeroplane. Please read this manual thoroughly before starting assembly of your **LANDSCAPE**. Use the parts listing below to identify all parts.

WARNING.

Please be aware that this aeroplane is not a toy and if assembled or used incorrectly it is capable of causing injury to people or property. WHEN YOU FLY THIS AEROPLANE YOU ASSUME ALL RISK & RESPONSIBILITY.

If you are inexperienced with basic R/C flight we strongly recommend you contact your R/C supplier and join your local R/C Model Flying Club. R/C Model Flying Clubs offer a variety of training procedures designed to help the new pilot on his way to successful R/C flight. They will also be able to advise on any insurance and safety regulations that may apply.

TOOLS & SUPPLIES NEEDED.

- Thick cyanoacrylate glue.
- 30 minute epoxy.
- 5 minute epoxy.
- Hand or electric drill.
- Assorted drill bits.
- Modelling knife.
- Straight edge ruler.
- 2mm ball driver.
- Phillips head screwdriver.
- 220 grit sandpaper.
- 90° square or builder's triangle.
- Wire cutters.
- Masking tape & T-pins.
- Thread-lock.
- Paper towels.

Some more parts.**HARDWARE PACK****COWLING.**

Landing gear.....

SUGGESTION.

To avoid scratching your new airplane, do not unwrap the pieces until they are needed for assembly. Cover your workbench with an old towel or brown paper, both to protect the aircraft and to protect the table. Keep a couple of jars or bowls handy to hold the small parts after you open the bag.

PARTS LISTING.**FUSELAGE ASSEMBLY**

- (1) Fuselage.

WING ASSEMBLY

- (1) Right wing half with pre-installed aileron.
- (1) Left wing half with pre-installed aileron.

Tail section assembly

- (1) Vertical stabilizer with pre-installed rudder.
- (1) Horizontal stabilizer with pre-installed elevator halves.

NOTE.

Please trial fit all the parts. Make sure you have the correct parts and that they fit and are aligned properly before gluing! This will assure proper assembly. **LANDSCAPE** ARF is hand made from natural materials, every plane is unique and minor adjustments may have to be made. However, you should find the fit superior and assembly simple.

The painted and plastic parts used in this kit are fuel proof. However, they are not tolerant of many harsh chemicals including the following: paint thinner, C/A glue accelerator, C/A glue debonder and acetone. Do not let these chemicals come in contact with the colors on the covering and the plastic parts.

Caution: this model is not a toy!

If you are a beginner to this type of powered model, please ask an experienced model flyer for help and support. If you attempt to operate the model without knowing what you are doing you could easily injure yourself or somebody else. Please keep your safety and well-being in mind at all times.

Important: before you start construction

Even if you have already built a large number of RC models please read right through these instructions and check all the kit components against the parts list. We have taken great trouble to keep construction as simple as possible, without making any compromises in the area of safety.

Note regarding the film covering

Minor creases or bubbles may develop in the film covering due to major fluctuations in weather conditions (temperature, humidity etc.); in rare cases you may even find a slight warp in a component. These minor faults are in the nature of film-covered built-up wooden structures, and can easily be corrected using a heat gun, as commonly used for modelling.

Creases: Blow warm air over the area and rub down with a soft cloth.

Wing warp: Hold the panel twisted gently in the opposite direction to the warp, and apply warm air to remove the creases from the covering.

Caution! do not heat the film more than is absolutely necessary. If the air or the iron is too hot, the film may melt and holes may be formed.

This model is highly pre-fabricated and can be built in a very short time. However, the work which you have to carry out is important and must be done carefully. The model will only be strong and fly well if you complete your tasks competently - so please work slowly and accurately.

When self-tapping screws have to be screwed into wood, apply a little white glue to prevent them shaking loose: just squirt white glue into the hole and fit the screw.

SAFETY PRECAUTION.

- + This is not a toy
- + Be sure that no other flyers are using your radio frequency.
- + Do not smoke near fuel
- + Store fuel in a cool, dry place, away from children and pets.
- + Wear safety glasses.
- + The glow plug clip must be securely attached to the glow plug.
- + Do not flip the propeller with your fingers.
- + Keep loose clothing and wires away from the propeller.
- + Do not start the engine if people are near. Do not stand in line with the side of the propeller.
- + Make engine adjustments from behind the propeller only. Do not reach around the spinning propeller.

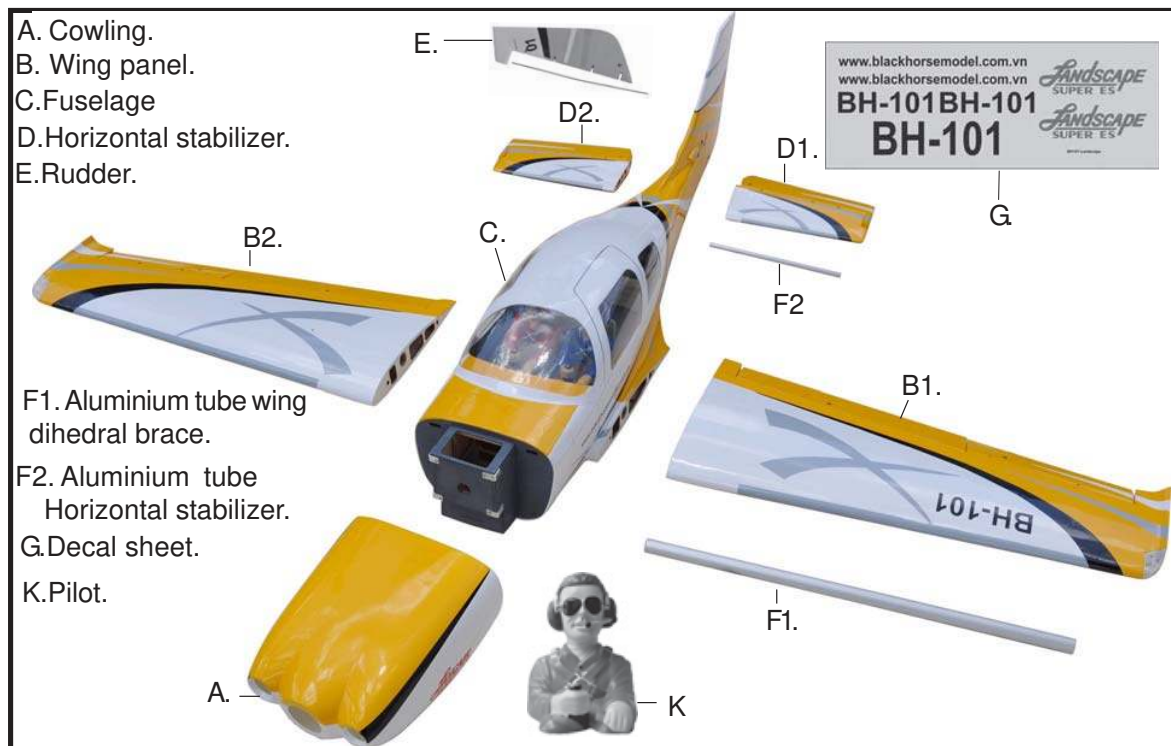



- 1. Aluminium landing gear.
- 2. Wheels.
- 3. Plastic part for nose gear.
- 4. Plastic parts for rudder pushrod.
- 5. Nose gear set.
- 6. Engine mount ply of wood .
- 7. Plastic parts for landing gear.
- 8. Wheel pants.
- 9. Fuel Tank.
- 10. Spinner.

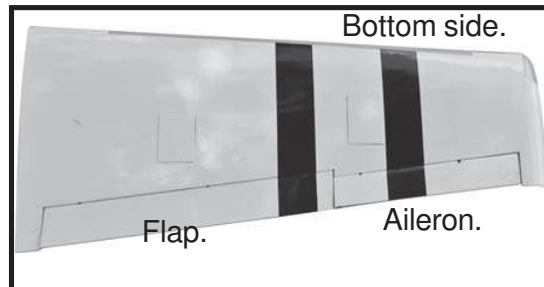

□ 2. Using a modeling knife, remove the covering servo tray.

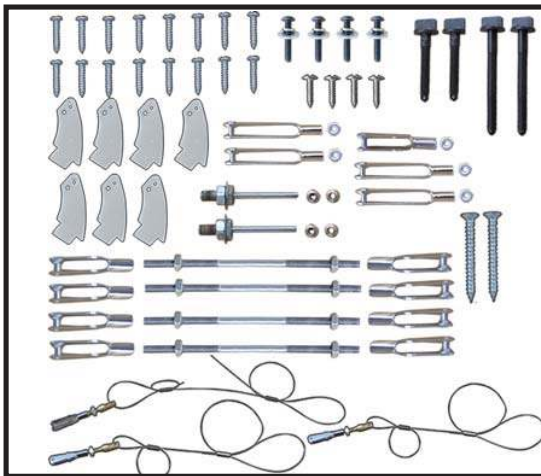

I. INSTALLING THE AILERON-FLAP SERVO

INSTALLING THE AILERON SERVOS.

□ 1. Install the rubber grommets and brass eyelets onto the aileron servo.

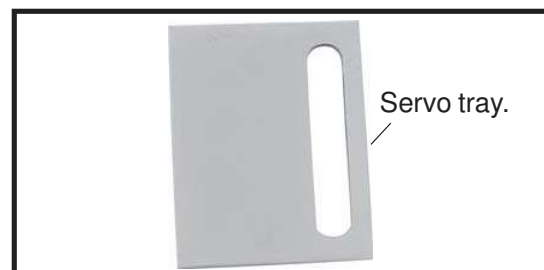
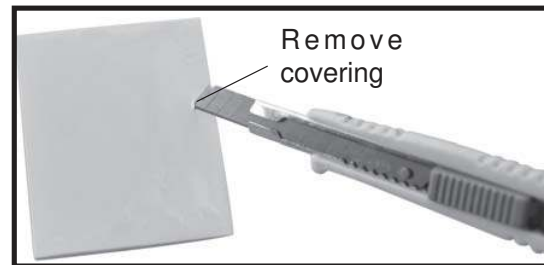

□ 3. Drill 1,5mm pilot holes through the block of wood for each of the four mounting screws provided with the servo. Install servo into aileron servo tray as same as picture below.

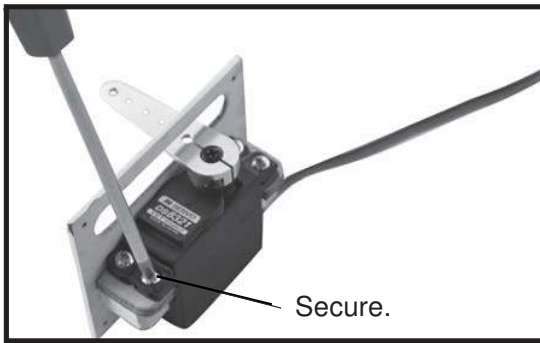

□ 4. Using the thread as a guide and using masking tape, tape the servo lead to the end of the thread: carefully pull the thread out. When you have pulled the servo lead out, remove the masking tape and the servo lead from the thread.

□ 5. Instal servo tray with aileron servo into the wing as same as picture below.

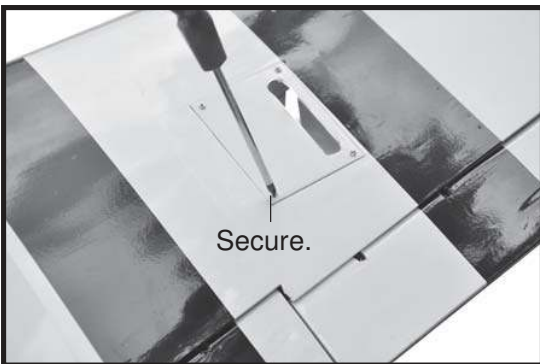
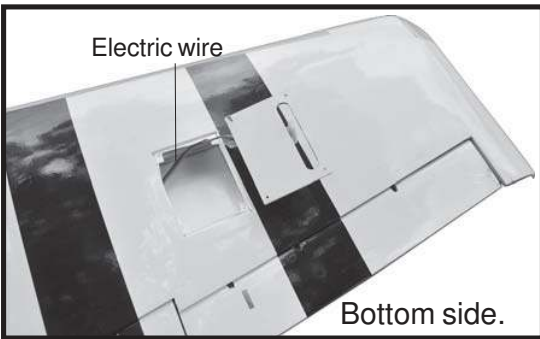

Repeat the procedure for the other wing half.

INSTALLING THE AILERON CONTROL HORN



Install aileron control horn as same as picture below.

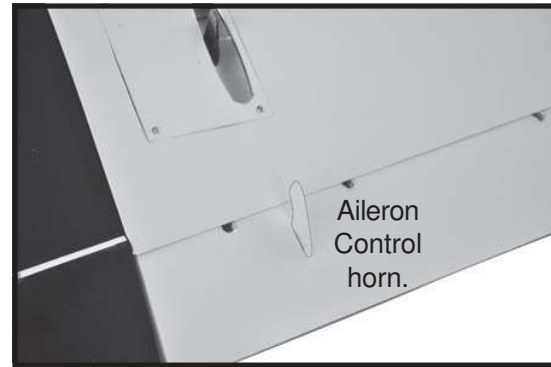
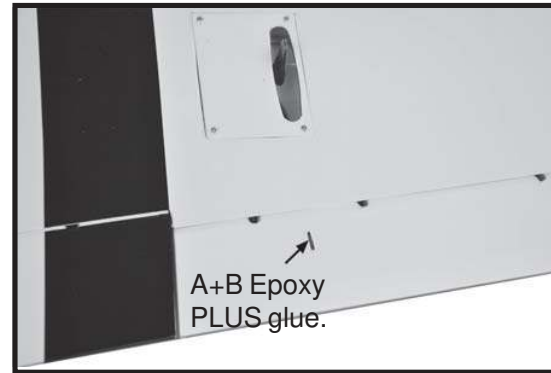

Repeat the procedure for the other wing half.

INSTALLING THE AILERON LINKAGES.

Installing the aileron linkages as pictures below.

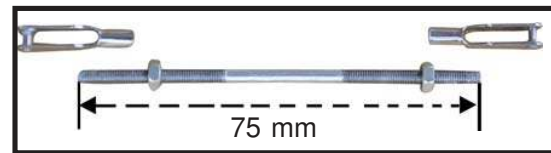

Attach the clevis to the outer hole in the control horn.



INSTALLING THE FLAP SERVO.

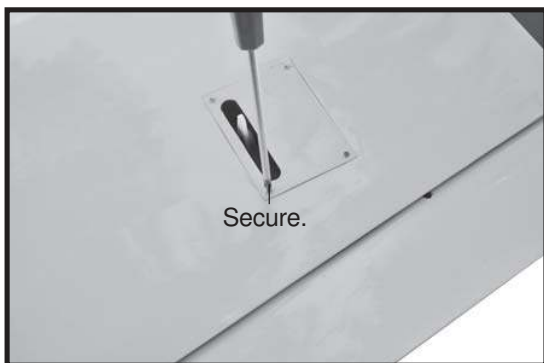
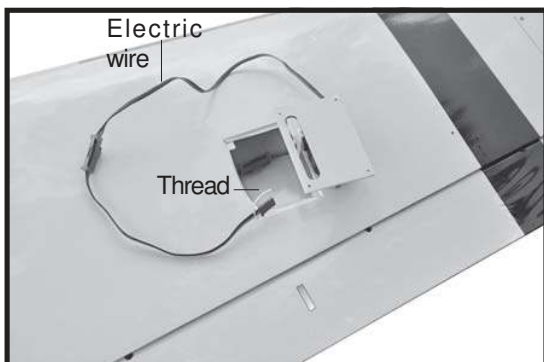

INSTALLING THE FLAP CONTROL HORN.

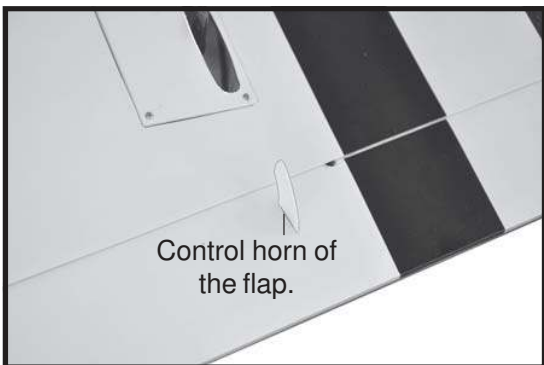
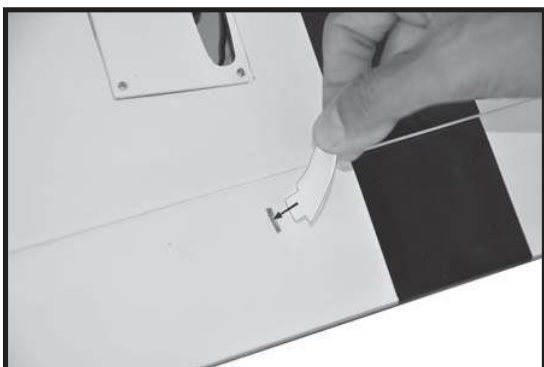
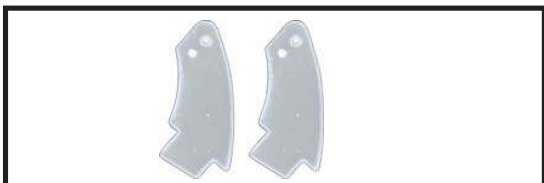

INSTALLING THE FLAP LINKAGES.

Installing the aileron linkages as pictures

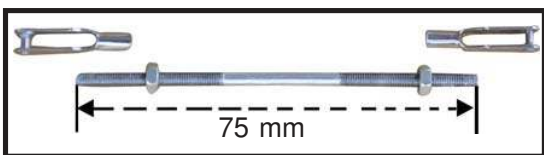

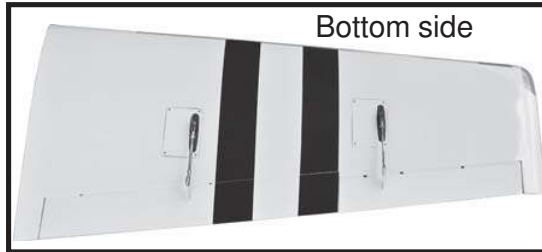
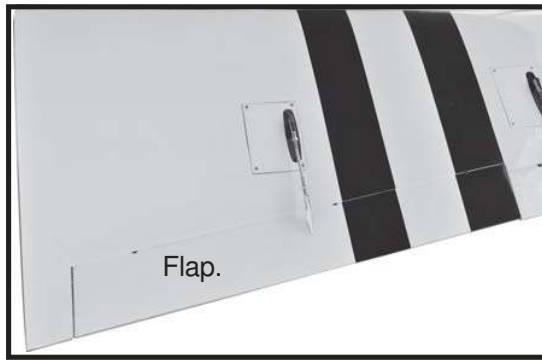

Repeat the procedure for the other wing half.

**INSTALLING THE ENGINE MOUNT
NOSE GEAR.**

See pictures below:

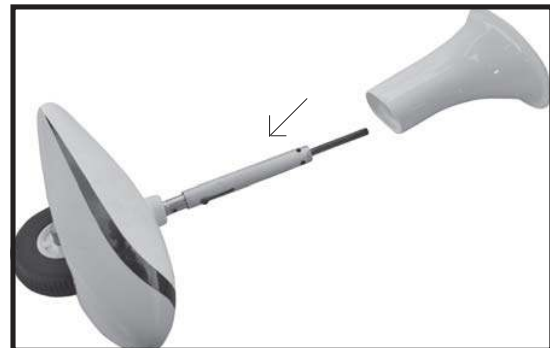
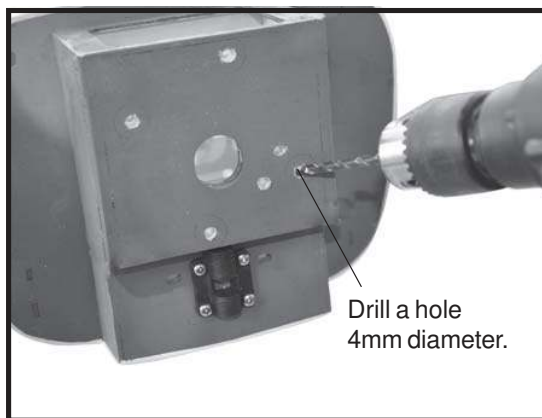

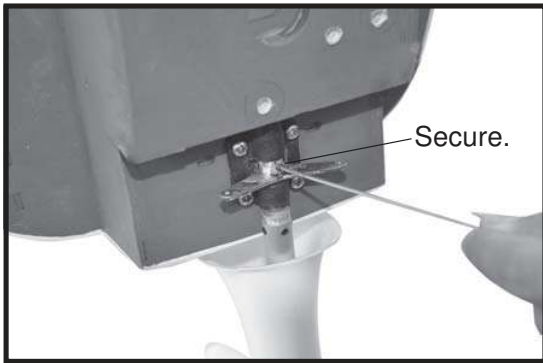
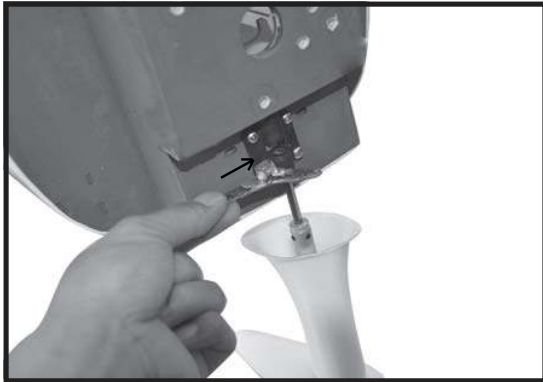

SERVO NOSE GEAR INSTALLATION.

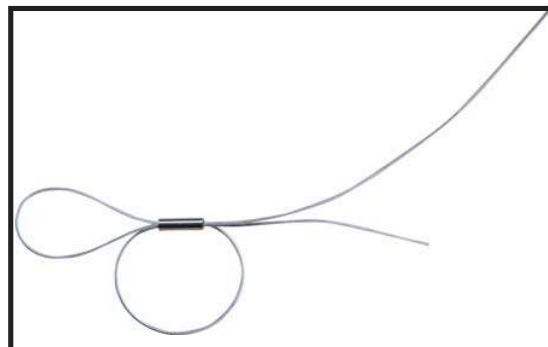
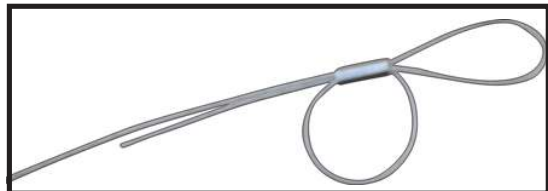
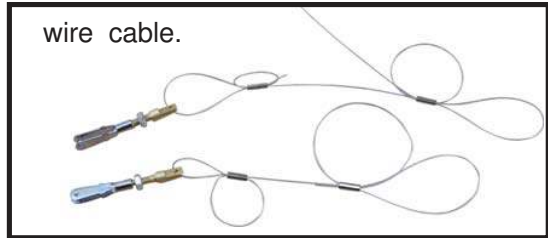
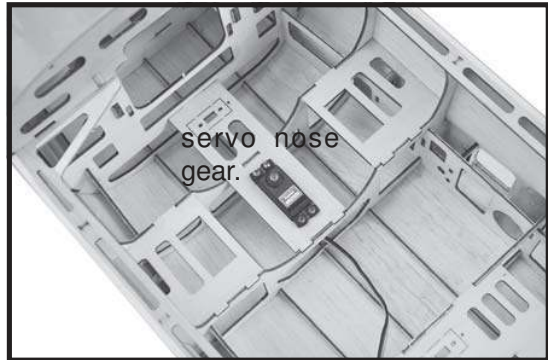
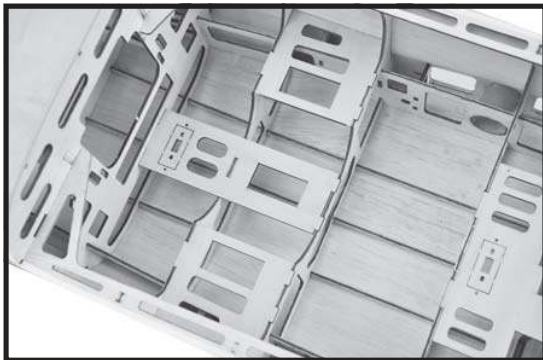

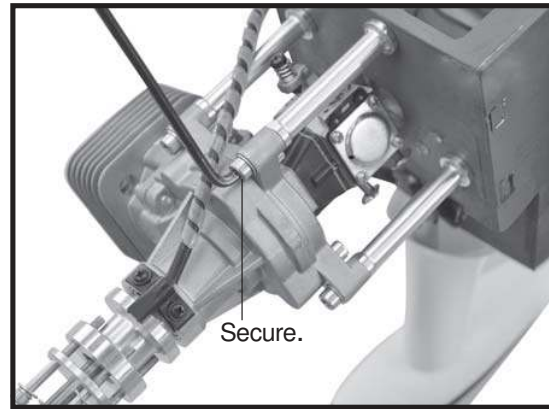
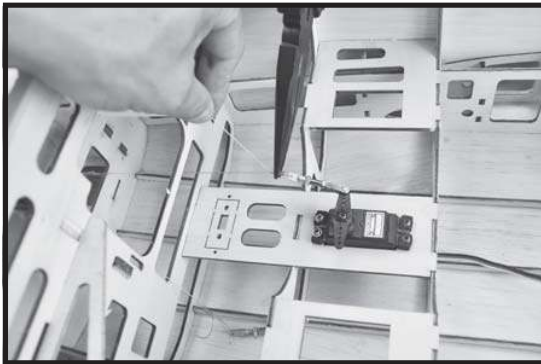
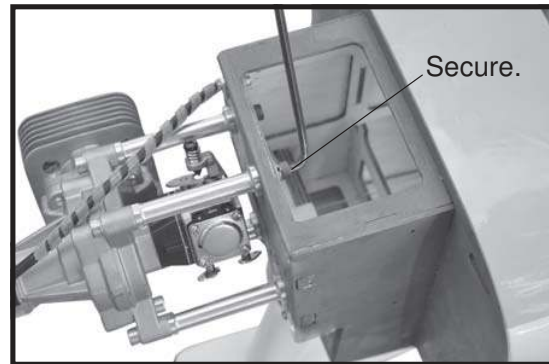
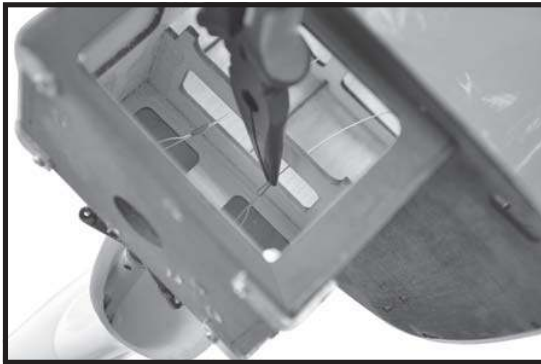

FUEL TANK.

INSTALLING THE STOPPER ASSEMBLY

- 1. The stopper has been pre-assembled at the factory.
- 2. Using a modeling knife, cut one length of silicon fuel line (the length of silicon fuel line is calculated by how the weighted clunk should rest about 8mm away from the rear of the tank and move freely inside the tank). Connect one end of the line to the weighted clunk and the other end to the nylon pick up tube in the stopper.
- 3. Carefully bend the second nylon tube up at a 45 degree angle (using a cigarette lighter). This tube will be the vent tube to the muffler.
- 4. Carefully bend the third nylon tube down at a 45 degree angle (using a cigarette lighter). This tube will be vent tube to the fueling valve.

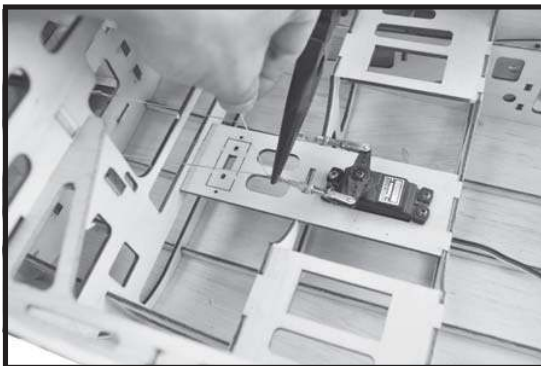

When the stopper assembly is installed in the tank, the top of the vent tube should rest just below the top surface of the tank. It should not touch the top of the tank.

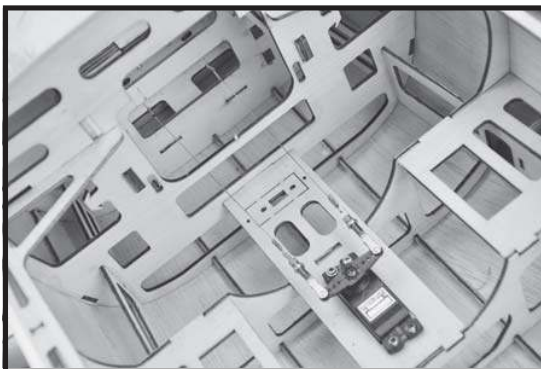

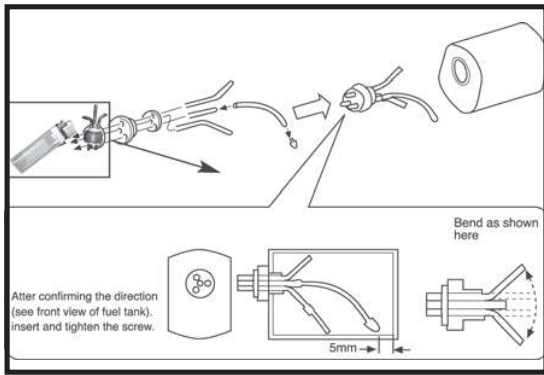

□ 5. Test fit the stopper assembly into the tank. It may be necessary to remove some of the flashing around the tank opening using a modeling knife. If flashing is present, make sure none of it falls into the tank.

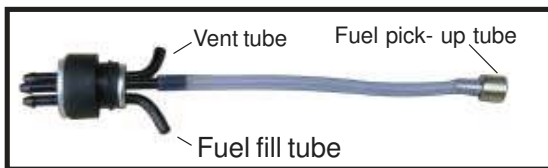
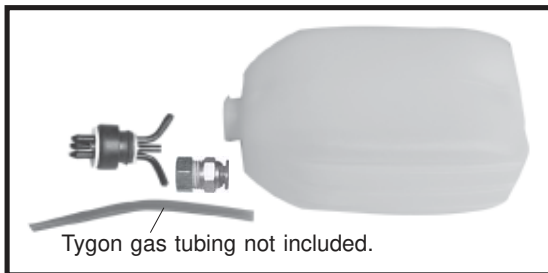

□ 6. When satisfied with the alignment of the stopper assembly tighten the 3mm x 20mm machine screw until the rubber stopper expands and seals the tank opening. Do not over tighten the assembly as this could cause the tank to split.

□ 7. Using a modeling knife, cut 3 lengths of fuel line 150mm long. Connect 2 lines to the 2 vent tubes and 1 line to the fuel pickup tube in the stopper.

□ 8. Feed three lines through the fuel tank compartment and through the pre-drilled hole in the firewall. Pull the lines out from behind the engine, while guiding the fuel tank into place. Push the fuel tank as far forward as possible, the front of the tank should just about touch the back of the firewall.

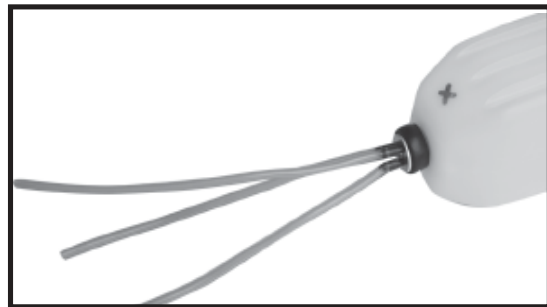
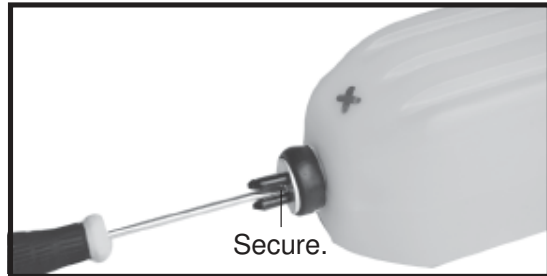
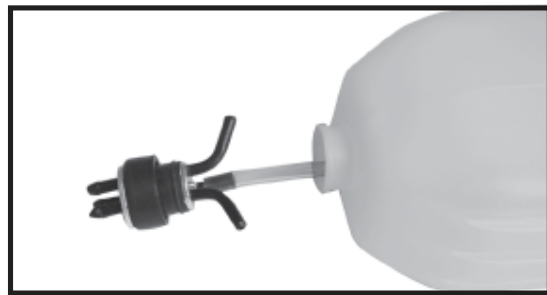

Blow through one of the lines to ensure the fuel lines have not become kinked inside the fuel tank compartment. Air should flow through easily.

□ 9. To secure the fuel tank in place, apply a bead of silicon sealer to the forward area of the tank, where it exits the fuselage behind the engine mounting box and to the rear of the tank at the forward bulkhead.

Do not secure the tank into place permanently until after balancing the airplane. You may need to remove the tank to mount the battery in the fuel tank compartment.

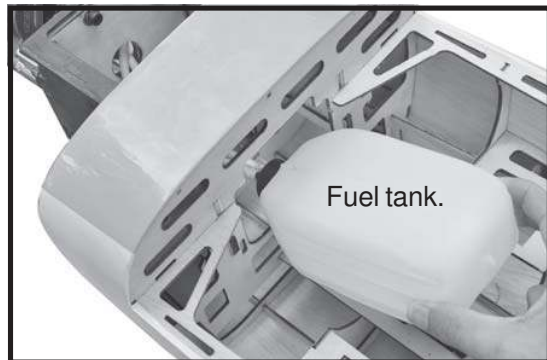

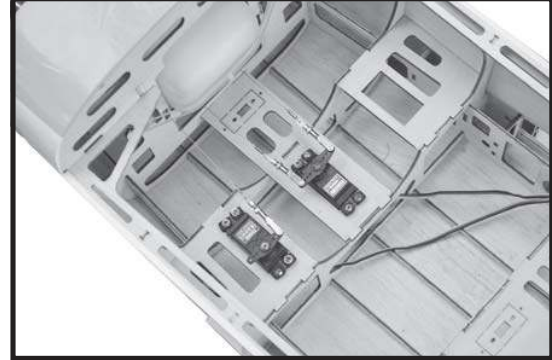
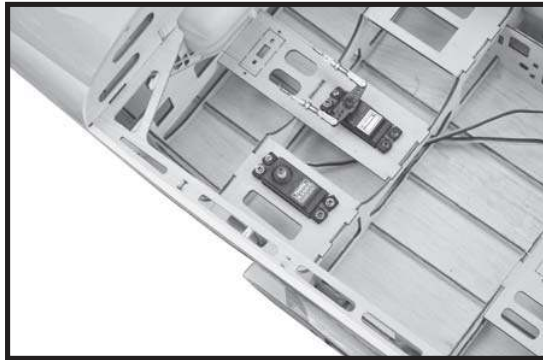
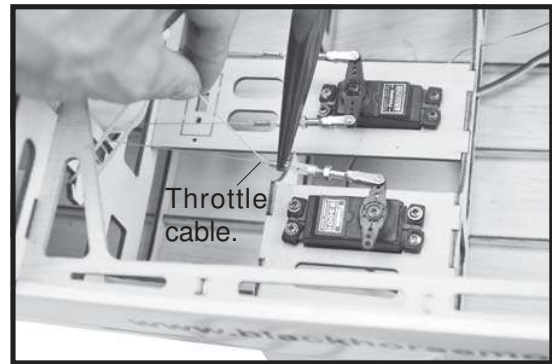
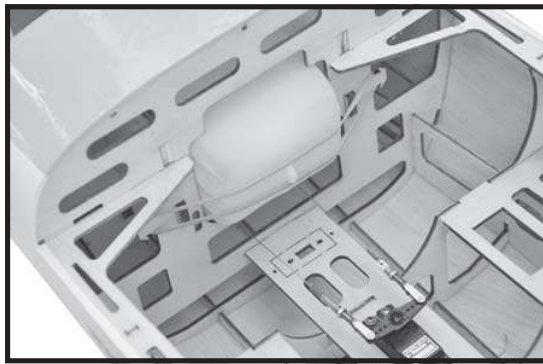

INSTALLING THE THROTTLE CABLE.

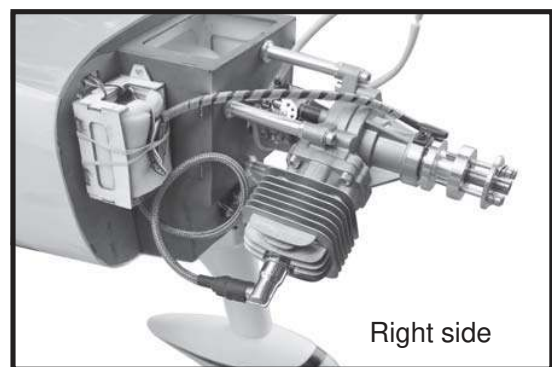
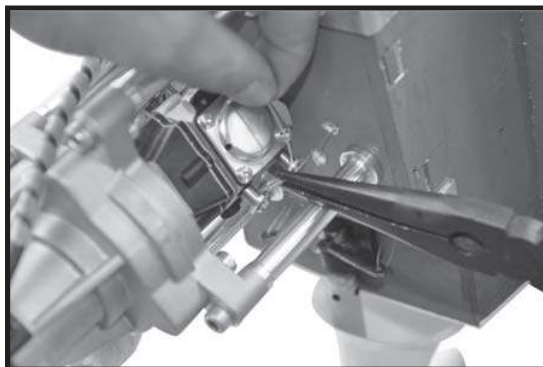
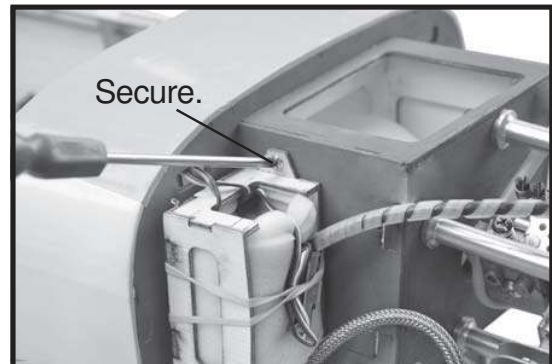
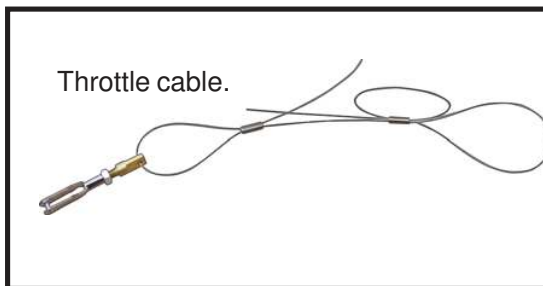

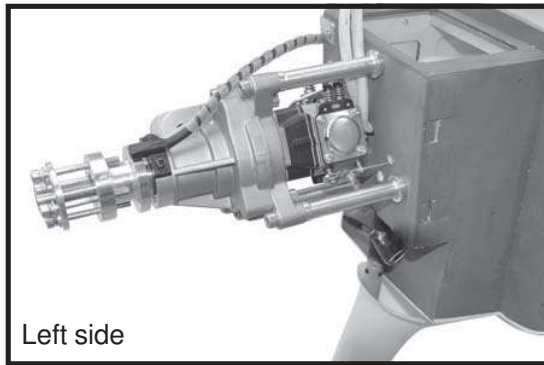

Left side

COWLING

□ 1. Slide the fiberglass cowl over the engine and line up the back edge of the cowl with the marks you made on the fuselage.

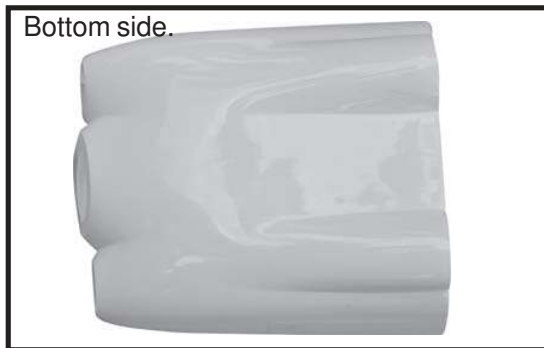

Bottom side.

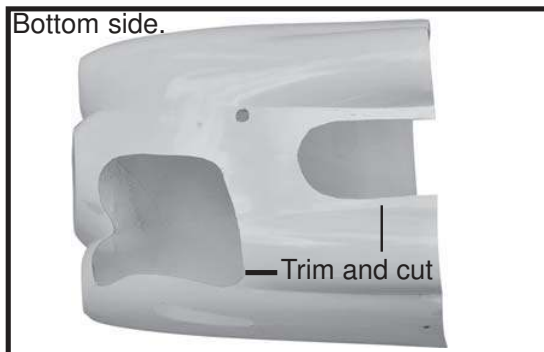

Bottom side.

Trim and cut

□ 2. While keeping the back edge of the cowl flush with the marks, align the front of the cowl with the crankshaft of the engine. The front of the cowl should be positioned so the crankshaft is in **nearly** the middle of the cowl opening. Hold the cowl firmly in place using pieces of masking tape.

□ 3. Slide the cowl back over the engine and secure it in place using four wood screws. See picture below.

□ 4. Install the muffler and muffler extension onto the engine and make the cutout in the cowl for muffler clearance. Connect the fuel and pressure lines to the carburetor, muffler and fuel filler valve.



3 x 12mm

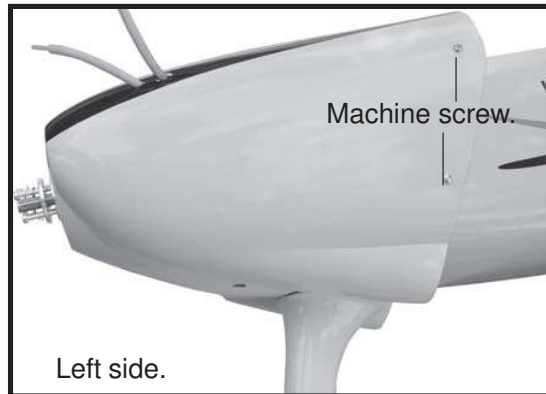

Left side.

Machine screw.

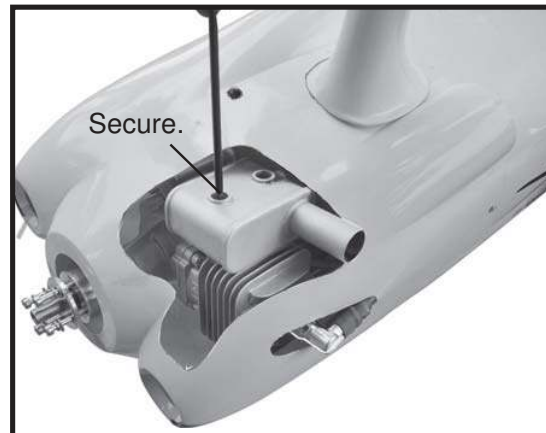

Secure.



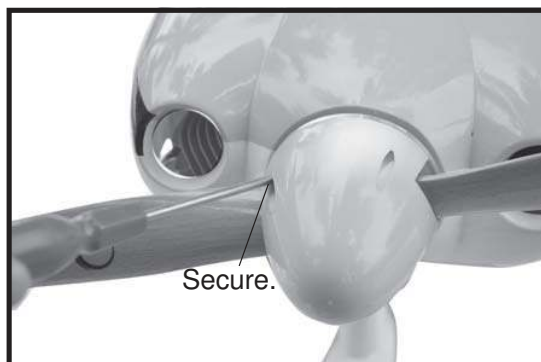
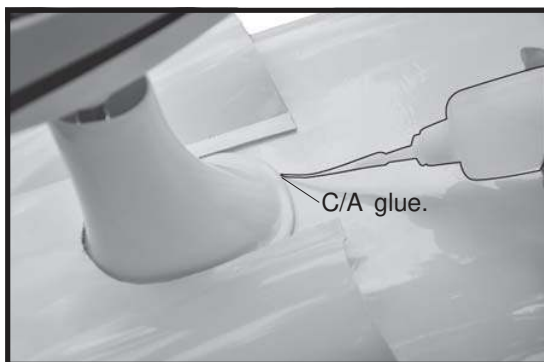

Front view.

MAIN GEAR INSTALLATION.

PARTS REQUIRED

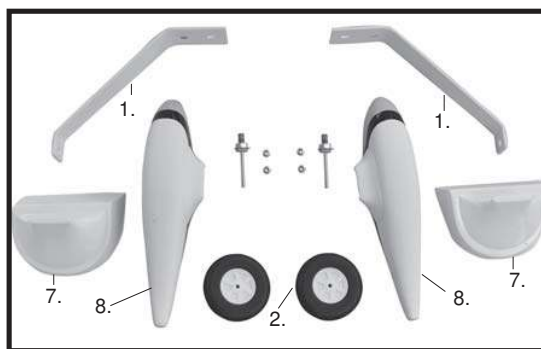

INSTALLING THE SPINNER.

Install the spinner backplate, propeller and spinner cone. The spinner cone is held in place using two 3mm x 12mm machine screws.

□ 1) Assemble and mounting the wheel parts as shown in the following pictures.



Plastic parts for landing gear.

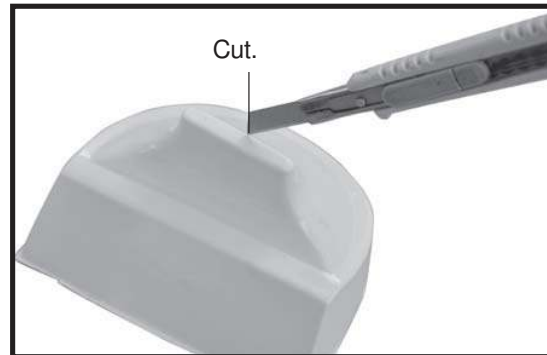
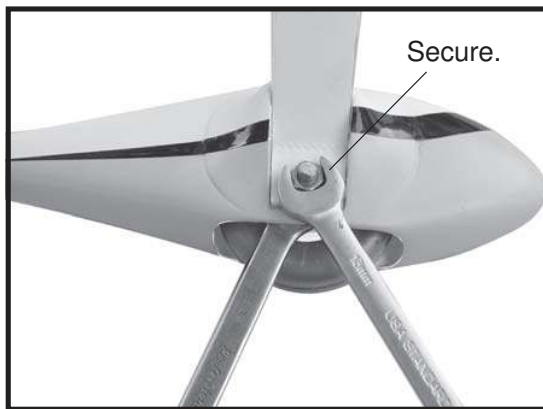
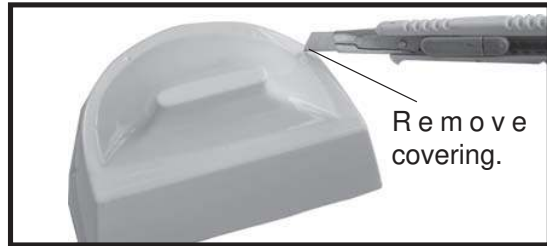
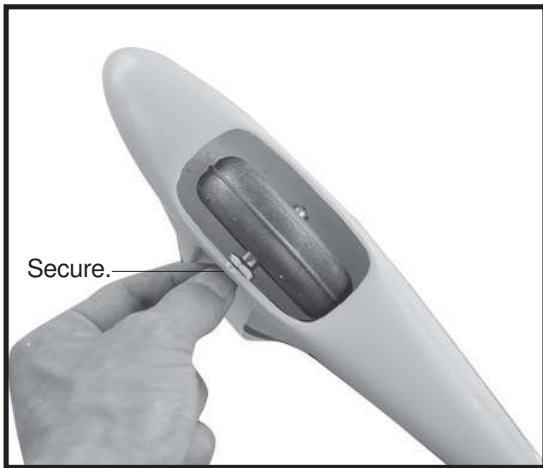

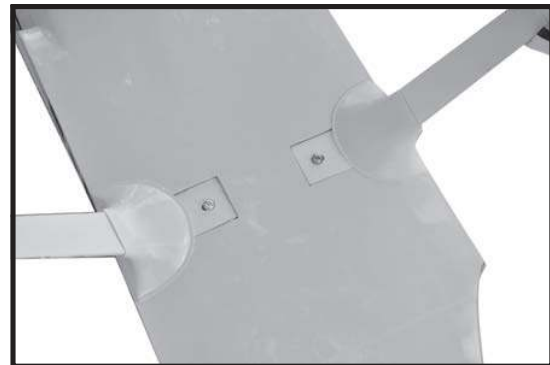
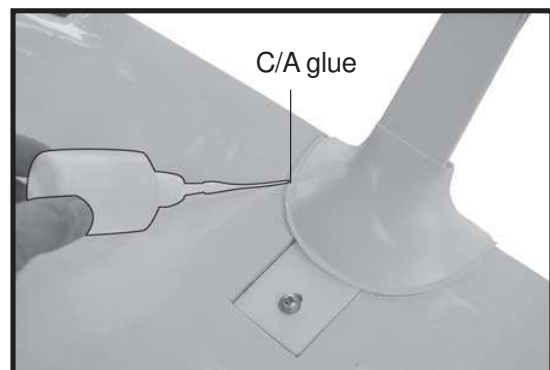
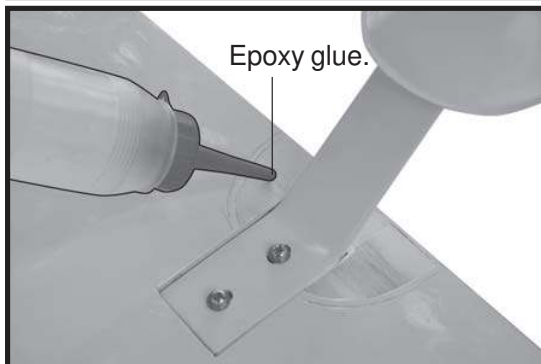
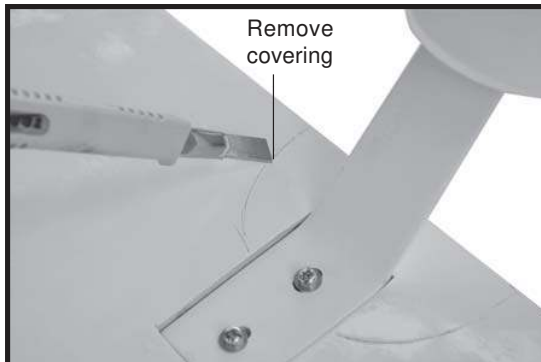
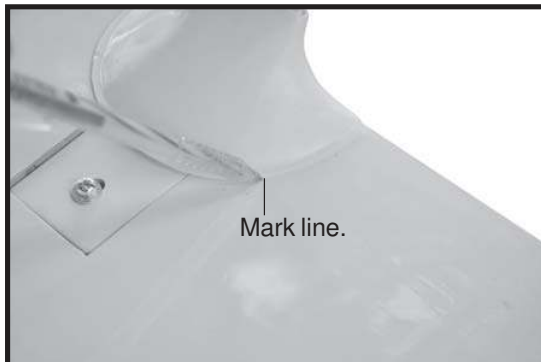
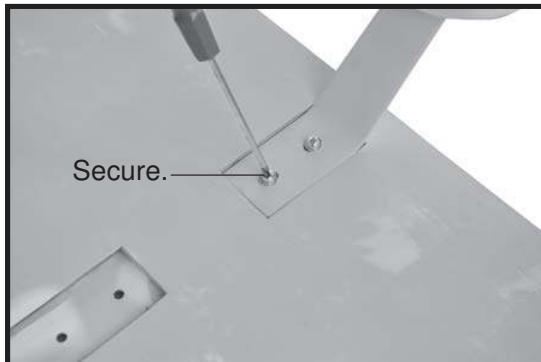
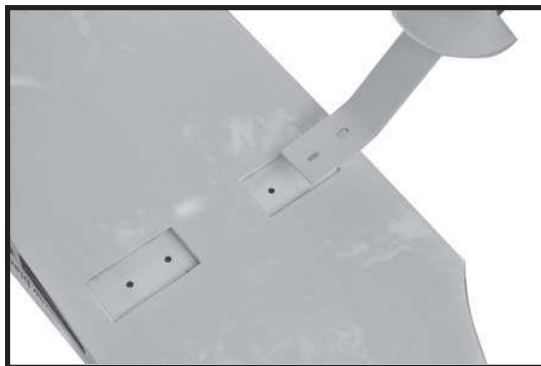

Repeat the process for the other wheel.

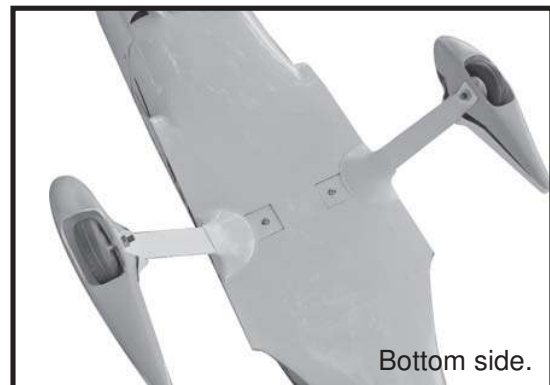

INSTALLING THE ELEVATOR SERVOS.



- 1. Install the rubber grommets and brass collets into the elevator servo. Test fit the servo into the servo tray.
- 2. Mount the servo to the tray using the mounting screws provided with your radio system.

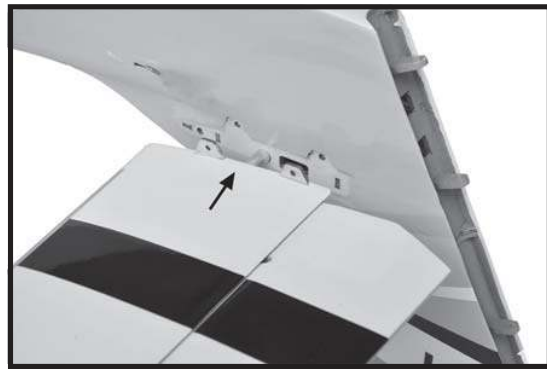
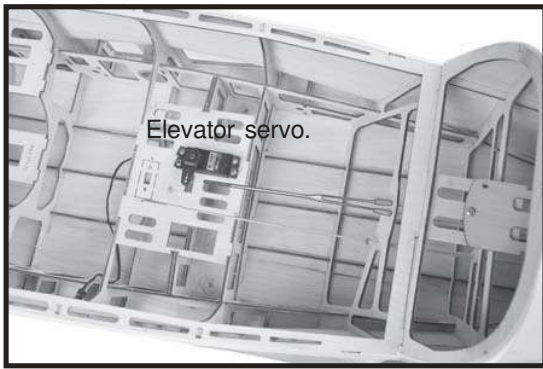

HORIZONTAL STABILIZER.

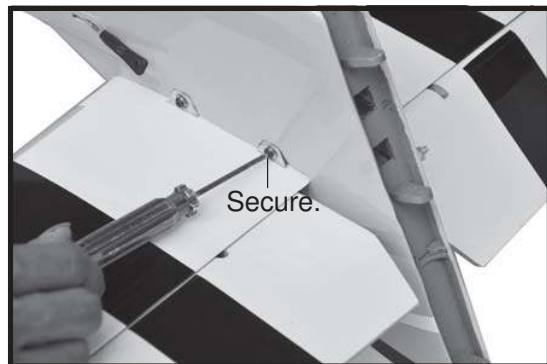
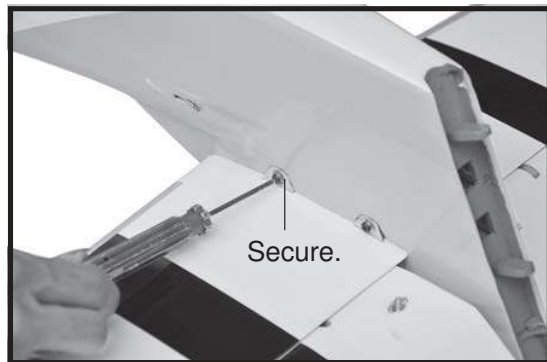
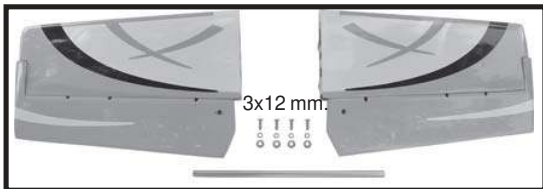

ELEVATOR CONTROL HORN INSTALLATION.

Elevator control horn install as same as the way of aileron control horn. Please see pictures below.



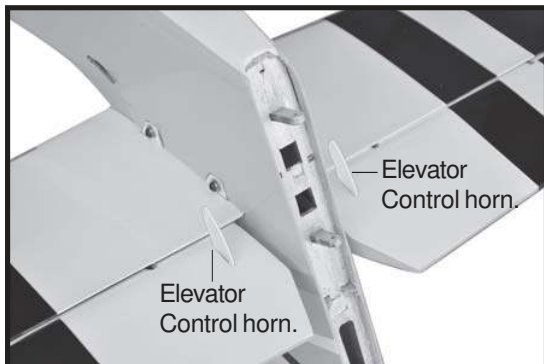
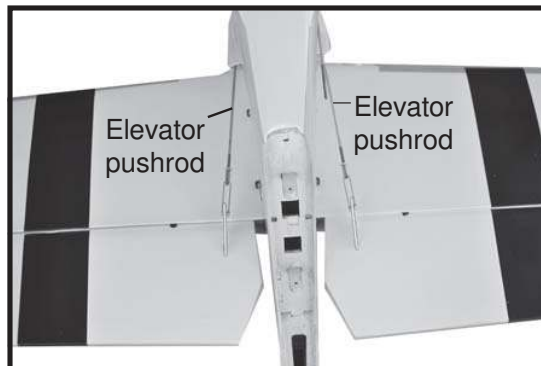
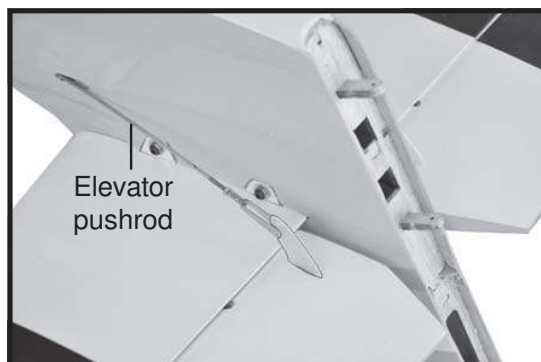

ELEVATOR PUSHROD INSTALLATION

☐ Elevator pushrod install as same as the way of aileron pushrod.

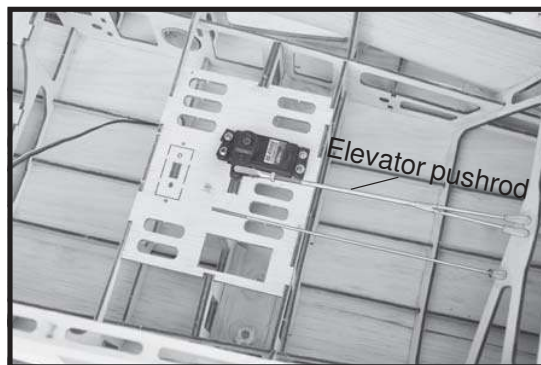

RUDDER SERVOS INSTALLATION.



Rudder servo install as same as method of elevator servo. See picture below:



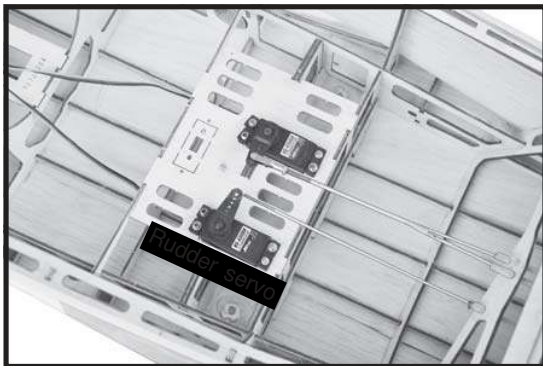

RUDDER SERVOS INSTALLATION.

See pitures bellow.

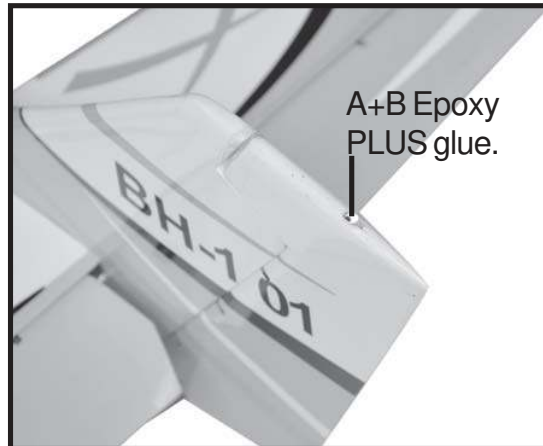
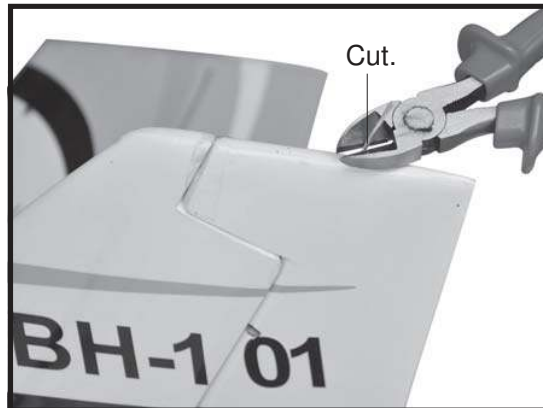
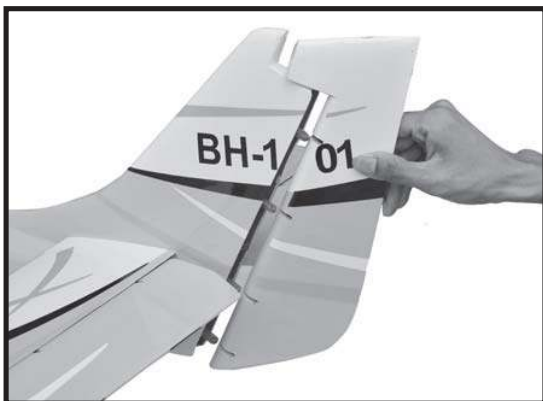
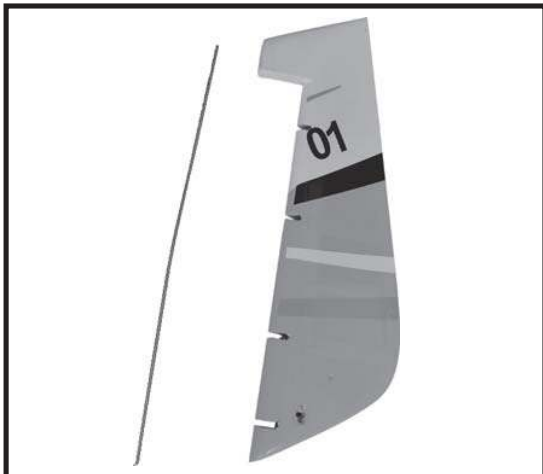

RUDDER CONTROL HORN INSTALLATION.

Rudder control horn install as same as the way of aileron control horn. Please see pictures below.

Control horn of Rudder.



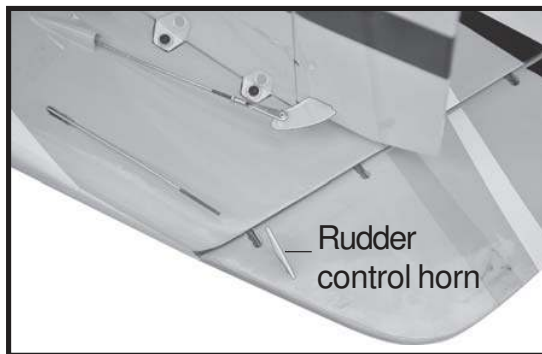
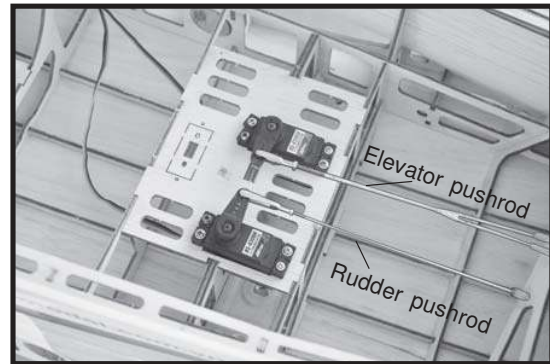
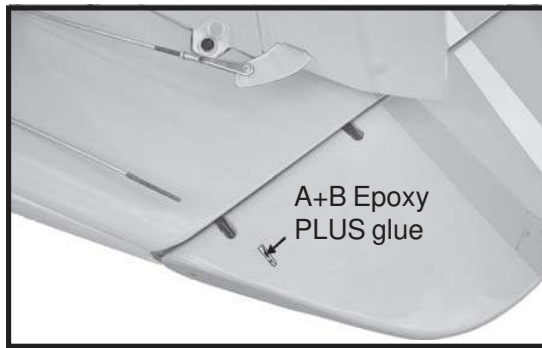

Plastic parts of pushrod.



RUDDER PUSHROD INSTALLATION.

- 1. Rudder pushrod install as same as the way of aileron control horn.

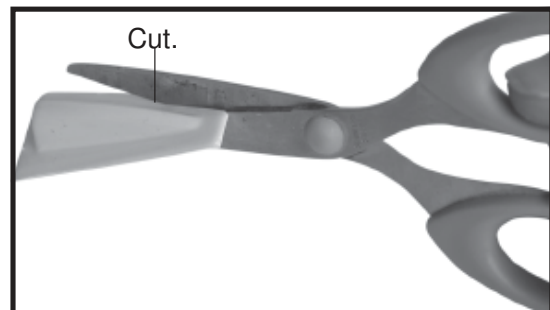

INSTALLING THE SWITCH.

- 1. Cut out the switch hole using a modeling knife. Use a 2mm drill bit and drill out the two mounting holes through the fuselage side.
- 2. Secure the switch in place using the two machine screws provided with the radio system.

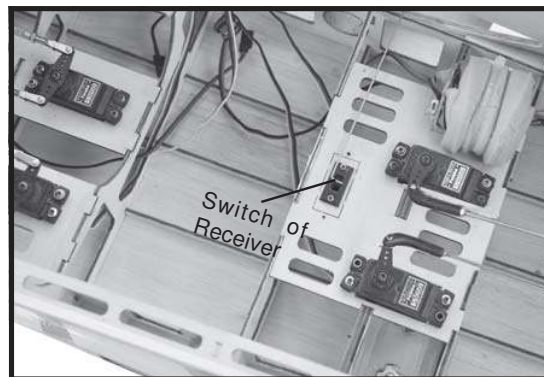
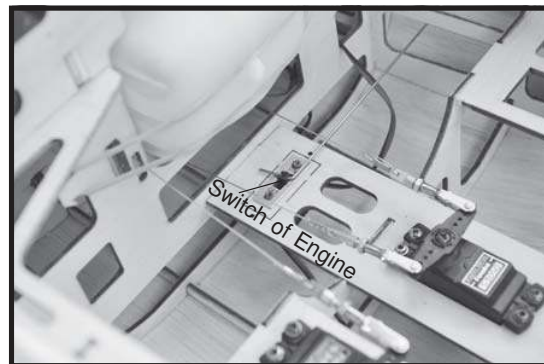
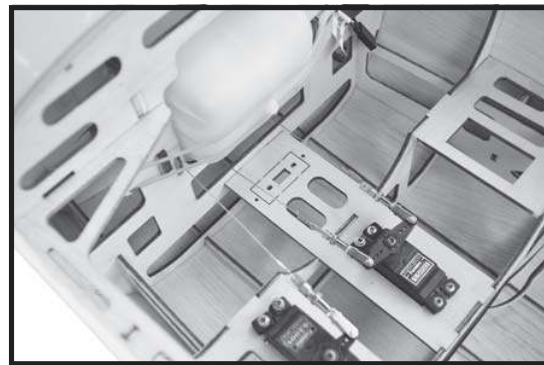
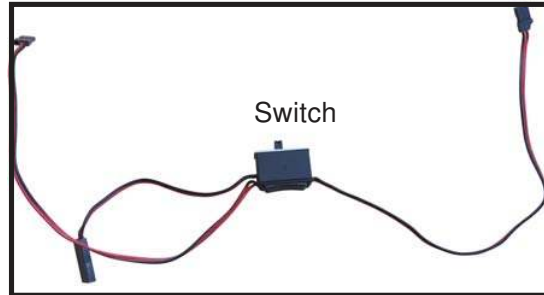
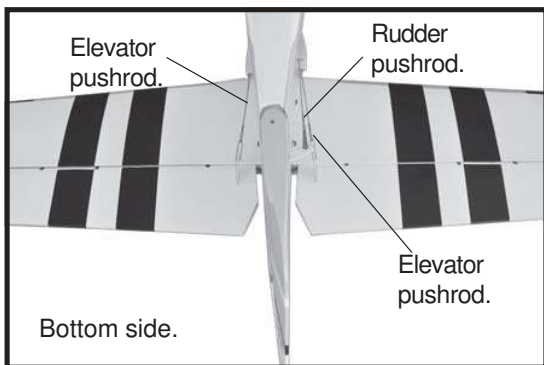
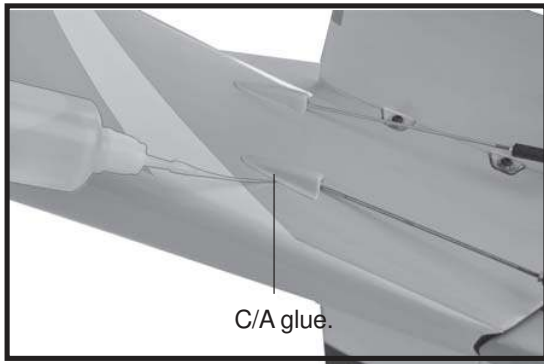
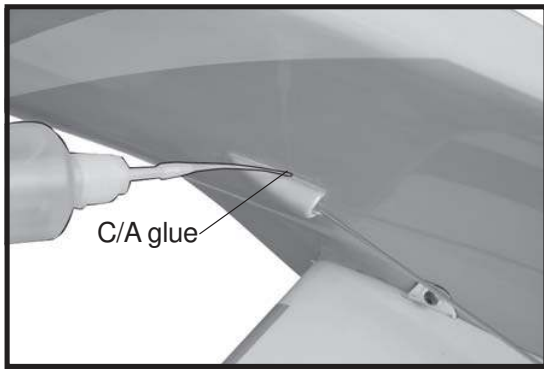

INSTALLING THE RECEIVER AND BATTERY.

- 1. Plug the servo leads and the switch lead into the receiver. You may want to plug an aileron extension into the receiver to make plugging in the aileron servo lead easier when you are installing the wing. Plug the battery pack lead into the switch.
- 2. Wrap the receiver and battery pack in the protective foam to protect them from vibration. Use a rubber band or masking tape to hold the foam in place.
- 3. Position the battery pack and receiver behind the fuel tank. Use two tie wraps to hold the battery and receiver securely in place as pictures below

Do not permanently secure the receiver and battery until after balancing the model.

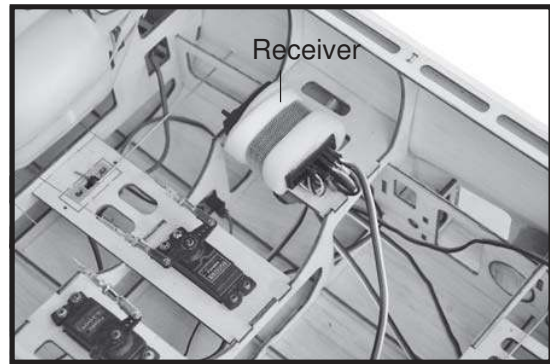
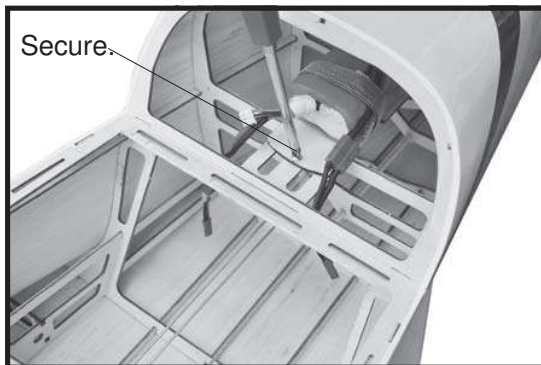
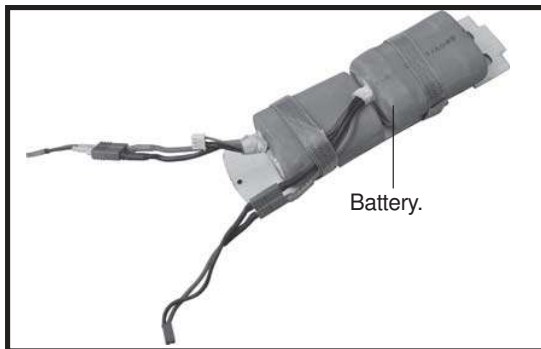
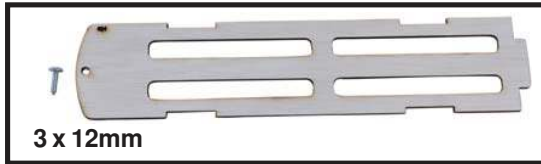

WING ATTACHMENT.

- Locate the aluminium wing dihedral brace.

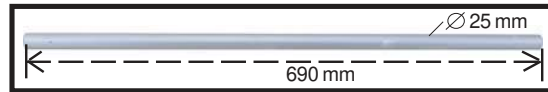

*** Test fit the aluminium tube dihedral brace into each wing haft. The brace should slide in easily. If not, use 220 grit sand around the edges and ends of the brace until it fits properly.

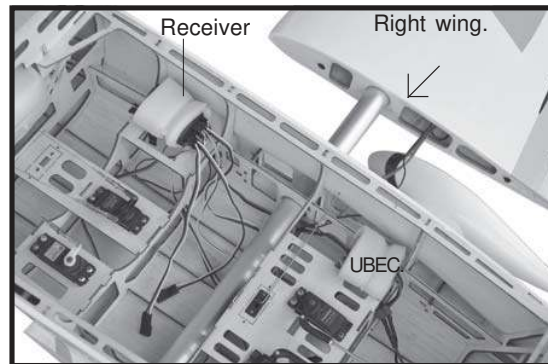
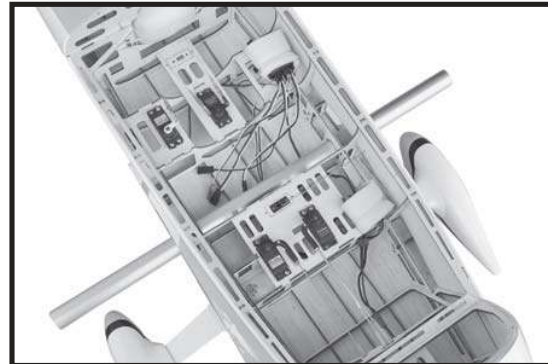

See picture wing attach to fuselage.

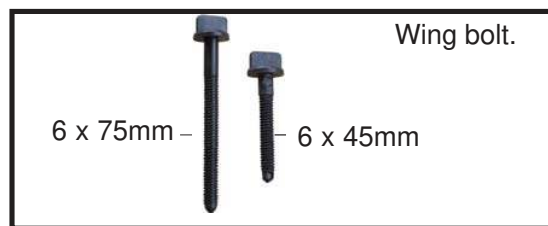

Installing the fuselage hatch as same as picture below.

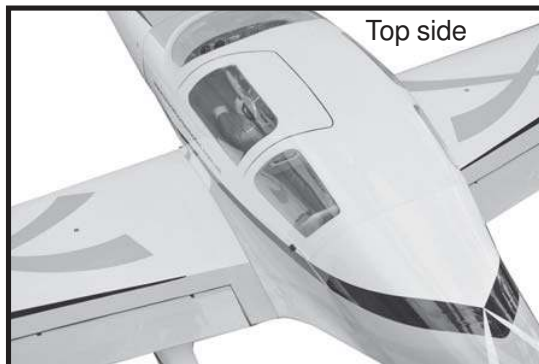
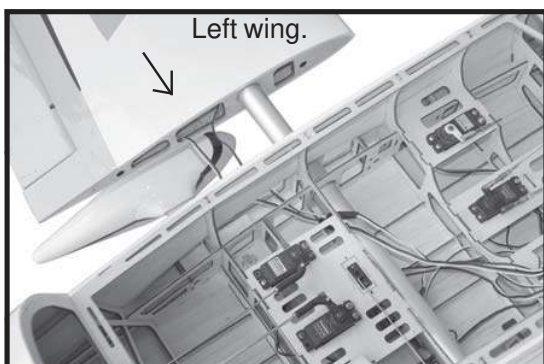
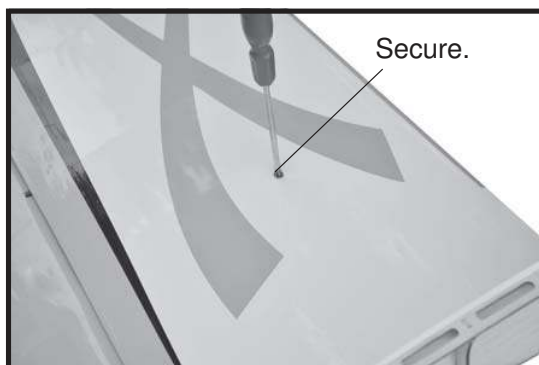
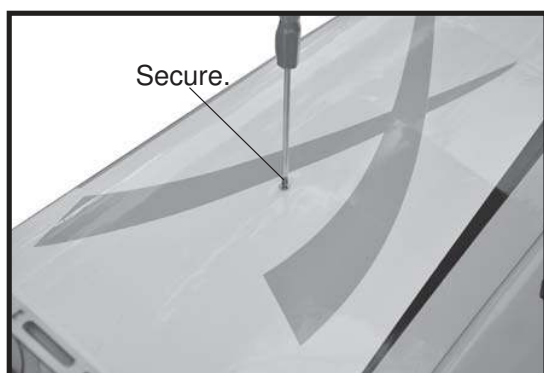
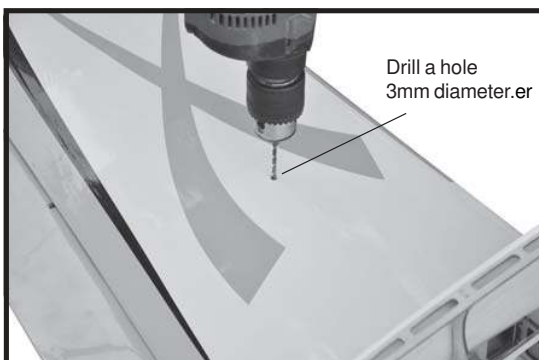
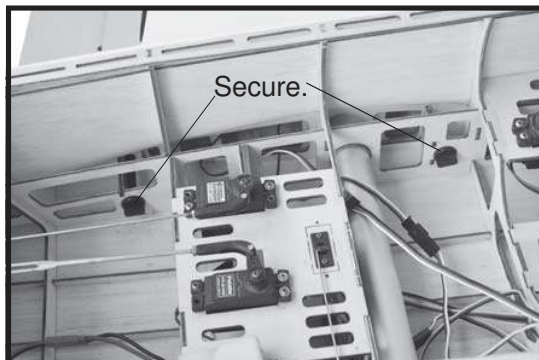
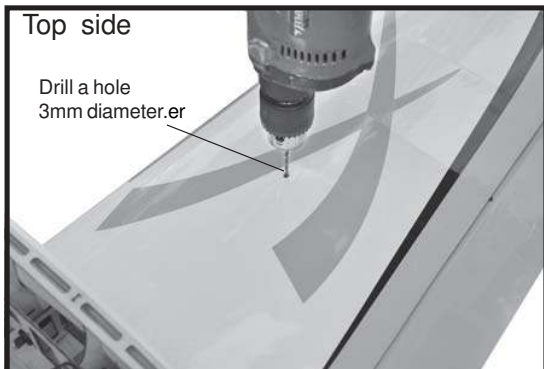
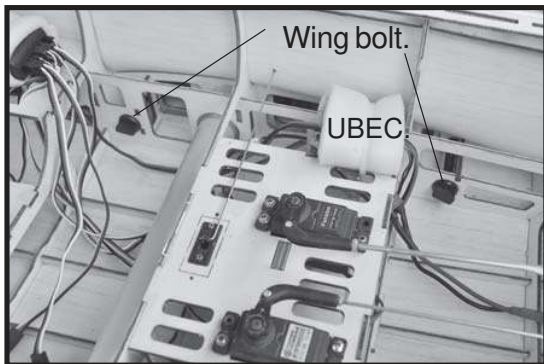

BALANCING

1. It is critical that your airplane be balanced correctly. Improper balance will cause your plane to lose control and crash.

THE CENTER OF GRAVITY IS LOCATED **97mm** BACK FROM THE LEADING EDGE OF THE WING.

2. Mount the wing to the fuselage. Using a couple of pieces of masking tape, place them on the top side of the wing **97mm** back from the leading edge, at the fuselage sides.

3. Turn the airplane upside down. Place your fingers on the masking tape and carefully lift the plane .

Accurately mark the balance point on the top of the wing on both sides of the fuselage. The balance point is located **97mm** back from the leading edge. This is the balance point at which your model should balance for your first flights. Later, you may wish to experiment by shifting the balance up to 10mm forward or back to change the flying characteristics. Moving the balance forward may improve the smoothness and arrow-like tracking, but it may then require more speed for take off and make it more difficult to slow down for landing. Moving the balance aft makes the model more agile with a lighter and snappier "feel". In any case, please start at the location we recommend .

With the wing attached to the fuselage, all parts of the model installed (ready to fly), and empty fuel tanks, hold the model at the marked balance point with the stabilizer level.

Lift the model. If the tail drops when you lift, the model is "tail heavy" and you must add weigh* to the nose. If the nose drops, it is "nose heavy" and you must add weight* to the tail to balance.

*If possible, first attempt to balance the model by changing the position of the receiver battery and receiver. If you are unable to obtain good balance by doing so, then it will be necessary to add weight to the nose or tail to achieve the proper balance point.

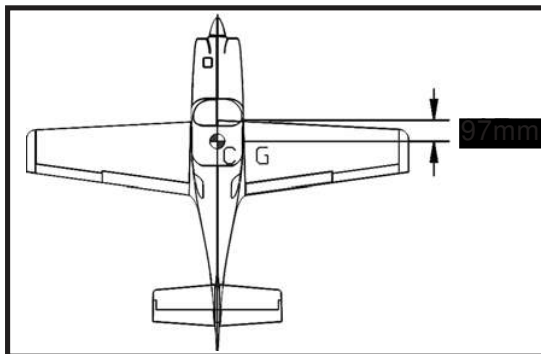
**CONTROL THROWS**

1. We highly recommend setting up a plane using the control throws listed.

2. The control throws should be measured at the widest point of each control surface.

3. Check to be sure the control surfaces move in the correct directions.

Ailerons : 15mm up 15mm down
 Flap : 25mm down
 Elevator : 12mm up 12mm down
 Rudder : 20mm

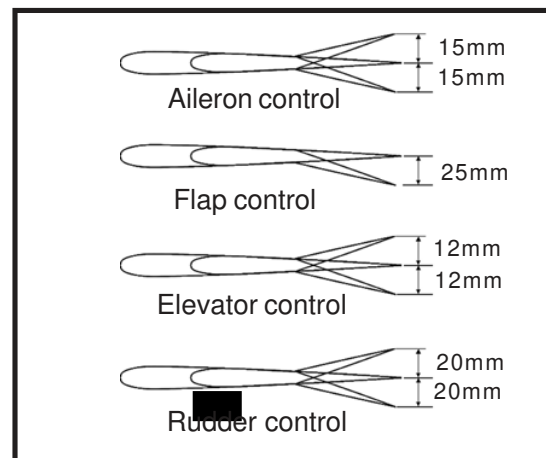
**PRE-FLIGHT CHECK.**

1. Completely charge your transmitter and receiver batteries before your first day of flying.

2. Check every bolt and every glue joint in your plane to ensure that everything is tight and well bonded.

3. Double check the balance of the airplane.

4. Check the control surface.

5. Check the receiver antenna . It should be fully extended and not coiled up inside the fuselage.

6. Properly balance the propeller.

We wish you many safe and enjoyable flights with your LANDSPACE.