

Mini FuntanaX



E-flite[®]
ADVANCING ELECTRIC FLIGHT

Assembly Manual

Table of Contents

Introduction	3	Safety, Precautions, and Warnings.....	12
Specifications	3	Landing Gear Installation.....	13
Using the Manual	3	Outrunner Motor Installation.....	15
Contents of Kit/Parts Layout	4	Cowling Installation	16
Required Radio Equipment	5	Aileron Hinging	20
Important Information About Motor Selection	6	Aileron Servos and Linkages	23
High Power Outrunner Setup.....	6	Wing Installation	27
Optional Accessories	6	Stabilizer and Elevator	30
Required Tools and Adhesives	6	Rudder and Fin.....	34
Note on Lithium Polymer Batteries	7	Rudder and Elevator Servos	36
Warning	7	Final Assembly	40
Date of Purchase Warranty Period	7	Control Throws	44
Limited Warranty	8	Center of Gravity.....	45
Damage Limits.....	9	Range Test Your Radio.....	46
Safety Precautions.....	9	Preflight	47
Questions, Assistance, and Repairs.....	9	Flying Your Mini FuntanaX	48
Inspection or Repairs.....	10	Building and Flying Notes.....	49
Warranty Inspection and Repairs.....	10	2006 Official AMA	
Non-Warranty Repairs.....	11	National Model Aircraft Safety Code.....	50

Introduction

Thank you for purchasing the Mini FuntanaX. To create the Mini Funtana X, E-flite started with the proven 3D benefits of the original Mini Funtana design then increased the wing area by 26%, added filets, added a tapered thickness airfoil and optional side force generators. The result is a plane that excels in high-alpha maneuverability, especially when outfitted with E-flite's phenomenal Park 480 Brushless Outrunner motor.

Specifications

Wingspan:	43 in (1092mm)
Length:	40.5 in (1028mm)
Wing Area:	447 sq in (28.8 sq dm)
Weight w/o Battery:	23–24 oz (652–680 g)
Weight w/ Battery:	27–29 oz (765–822 g)

Using the Manual

This manual is divided into sections to help make assembly easier to understand, and to provide breaks between each major section. In addition, check boxes have been placed next to each step to keep track of each step completed. Steps with a single circle (○) are performed once, while steps with two circles (○ ○) indicate that the step will require repeating, such as for a right or left wing panel, two servos, etc.

Remember to take your time and follow the directions.

Contents of Kit/Parts Layout

Large Replacement Parts:

EFL2426	Wing w/Ailerons
EFL2427	Fuselage w/Hatch
EFL2428	Tail Set
EFL2429	Pushrod Set
EFL2430	Main Landing Gear
EFL2431	Fuselage Hatch
EFL2432	Canopy
EFL2433	Cowling
EFL2434	Wheel Pants
EFL2435	Wing Tube
EFL2436	Side Force Generators

Small Replacement Parts:

EFLA200	Micro Control Horns
EFLA203	Micro Control Connectors
EFLA219	Steerable Tailwheel Assembly
EFLA222	Foam Park Wheels, 1 3/4"
EFLA213	E-flite/JR/Horizon Decals

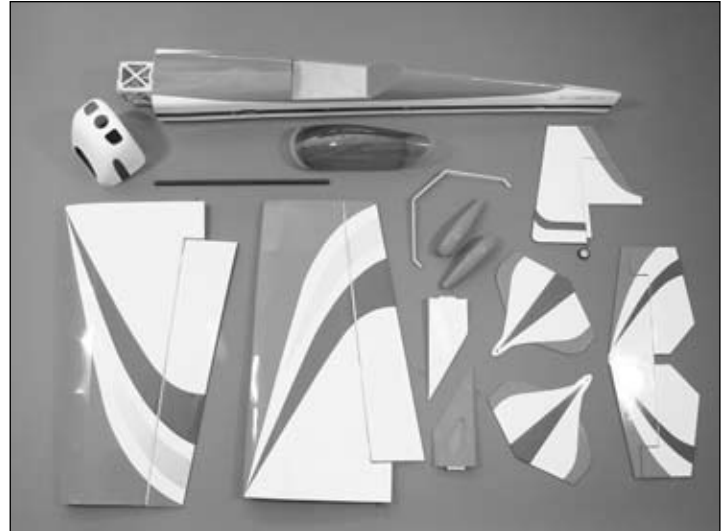

Required Radio Equipment

You will need a minimum 6-channel transmitter, crystals, micro receiver, and four sub-micro servos. You can choose to purchase a complete radio system that includes all of these items or, if you are using an existing transmitter, just purchase the other required equipment separately.

Complete Radio System

SPM2460 DX6 DSM 6CH Park Flyer w/4-S75 Servos

Note: We recommend the crystal-free, interference-free Spektrum® DX6 2.4GHz DSM® 6-Channel System, which includes a micro receiver and 4 sub-micro servos.

Or Purchase Separately

SPM6000 AR6000 DSM DualLink™ 6-Channel Park Flyer Rx

Or

JSP30610

6-Channel UltraLite Rx w/o Crystal, Positive Shift JR/AIR (72MHz)

Or

JSP30615

6-Channel UltraLite Rx w/o Crystal, Negative Shift FUT/HRC (72MHz)

JRPXFR**

JSP98110

JSP98120

JSP98020

EFLRS75

FM Receiver Crystal

6" Servo Extension (2)

18" Servo Extension (2)

Y-Harness, Standard 6"

7.5-Gram Sub-Micro Servo (4)

Important Information About Motor Selection

We recommend the E-flite® Park 480 Brushless Outrunner, 1020Kv (EFLM1505) to provide you with excellent sport and aerobic power and a worry-free outrunner motor. The Mini FuntanaX does not include a propeller.

High Power Outrunner Setup

EFLM1505	Park 480 Brushless Outrunner Motor, 1020Kv
EFLA312B	40-Amp Brushless ESC
THP21003SPL	2100mAh 3-Cell 11.1V Li-Po, 16GA
APC12060E	12 x 6 Electric Prop
EFLAEC302	EC3 Battery Connector, Female (2)
EFLC3005	Collectra 1- to 3-cell Li-Po Charger

This is a high power performance setup for strong 3D flights.

Optional Accessories

EFLA110	Power Meter
---------	-------------

Required Tools and Adhesives

Tools & Equipment

EFLA250 Park Flyer Tool Assortment, 5-piece

Or Purchase Separately

EFLA257 Screwdriver, #0 Phillips (or included with EFLA250)
EFLA251 Hex Wrench: 3/32" (or included with EFLA250)

Nut driver: 1/4"

Drill

Drill bit: 1/16" (1.5mm), 5/64" (2mm)

Masking tape

Card stock

Felt-tipped pen

Needle-nose pliers

Canopy glue

Medium grit sandpaper

T-pins

Thin CA

Paper towels

Hobby knife

6-minute epoxy

Ruler

Square

Note on Lithium Polymer Batteries



Lithium Polymer batteries are significantly more volatile than alkaline or Ni-Cd/Ni-MH batteries used in RC applications. All manufacturer's instructions and warnings must be followed closely. Mishandling of Li-Po batteries can result in fire. Always follow the manufacturer's instructions when disposing of Lithium Polymer batteries.

Warning

An RC aircraft is not a toy! If misused, it can cause serious bodily harm and damage to property. Fly only in open areas, preferably at AMA (Academy of Model Aeronautics) approved flying sites, following all instructions included with your radio.

Keep loose items that can get entangled in the propeller away from the prop, including loose clothing, or other objects such as pencils and screwdrivers. Especially keep your hands away from the propeller.

Date of Purchase Warranty Period

Horizon Hobby, Inc., (Horizon) warrants that the Products purchased (the "Product") will be free from defects in materials and workmanship at the date of purchase by the Purchaser.

Limited Warranty

(a) This warranty is limited to the original Purchaser ("Purchaser") and is not transferable. REPAIR OR REPLACEMENT AS PROVIDED UNDER THIS WARRANTY IS THE EXCLUSIVE REMEDY OF THE PURCHASER. This warranty covers only those Products purchased from an authorized Horizon dealer. Third party transactions are not covered by this warranty. Proof of purchase is required for warranty claims. Further, Horizon reserves the right to change or modify this warranty without notice and disclaims all other warranties, express or implied.

(b) Limitations- HORIZON MAKES NO WARRANTY OR REPRESENTATION, EXPRESS OR IMPLIED, ABOUT NON-INFRINGEMENT, MERCHANTABILITY OR FITNESS FOR A PARTICULAR PURPOSE OF THE PRODUCT. THE PURCHASER ACKNOWLEDGES THAT THEY ALONE HAVE DETERMINED THAT THE PRODUCT WILL SUITABLY MEET THE REQUIREMENTS OF THE PURCHASER'S INTENDED USE.

(c) Purchaser Remedy- Horizon's sole obligation hereunder shall be that Horizon will, at its option, (i) repair or (ii) replace, any Product determined by Horizon to be defective. In the event of a defect, these are the Purchaser's exclusive remedies. Horizon reserves the right to inspect any and all equipment involved in a warranty claim. Repair or replacement decisions are at the sole discretion of Horizon. This warranty does not cover cosmetic damage or damage due to acts of God, accident, misuse, abuse, negligence, commercial use, or modification of or to any part of the Product. This warranty does not cover damage due to improper installation, operation, maintenance, or attempted repair by anyone other than Horizon. Return of any goods by Purchaser must be approved in writing by Horizon before shipment.

Damage Limits

HORIZON SHALL NOT BE LIABLE FOR SPECIAL, INDIRECT OR CONSEQUENTIAL DAMAGES, LOSS OF PROFITS OR PRODUCTION OR COMMERCIAL LOSS IN ANY WAY CONNECTED WITH THE PRODUCT, WHETHER SUCH CLAIM IS BASED IN CONTRACT, WARRANTY, NEGLIGENCE, OR STRICT LIABILITY. Further, in no event shall the liability of Horizon exceed the individual price of the Product on which liability is asserted. As Horizon has no control over use, setup, final assembly, modification or misuse, no liability shall be assumed nor accepted for any resulting damage or injury. By the act of use, setup or assembly, the user accepts all resulting liability.

If you as the Purchaser or user are not prepared to accept the liability associated with the use of this Product, you are advised to return this Product immediately in new and unused condition to the place of purchase.

Law: These Terms are governed by Illinois law (without regard to conflict of law principals).

Safety Precautions

This is a sophisticated hobby Product and not a toy. It must be operated with caution and common sense and requires some basic mechanical ability. Failure to operate this Product in a safe and responsible manner could result in injury or damage to the Product or other property. This Product is not intended for use by children without direct adult supervision. The Product manual contains instructions for safety, operation and maintenance. It is essential to read and follow all the instructions and warnings in the manual, prior to assembly, setup or use, in order to operate correctly and avoid damage or injury.

Questions, Assistance, and Repairs

Your local hobby store and/or place of purchase cannot provide warranty support or repair. Once assembly, setup or use of the Product has been started, you must contact Horizon directly. This will enable Horizon to better answer your questions and service you in the event that you may need any assistance. For questions or assistance, please direct your email to productsupport@horizonhobby.com, or call 877.504.0233 toll free to speak to a service technician.

Inspection or Repairs

If this Product needs to be inspected or repaired, please call for a Return Merchandise Authorization (RMA). Pack the Product securely using a shipping carton. Please note that original boxes may be included, but are not designed to withstand the rigors of shipping without additional protection. Ship via a carrier that provides tracking and insurance for lost or damaged parcels, as **Horizon is not responsible for merchandise until it arrives and is accepted at our facility.** A Service Repair Request is available at www.horizonhobby.com on the "Support" tab. If you do not have internet access, please include a letter with your complete name, street address, email address and phone number where you can be reached during business days, your RMA number, a list of the included items, method of payment for any non-warranty expenses and a brief summary of the problem. Your original sales receipt must also be included for warranty consideration. Be sure your name, address, and RMA number are clearly written on the outside of the shipping carton.

Warranty Inspection and Repairs

To receive warranty service, you must include your original sales receipt verifying the proof-of-purchase date. Provided warranty conditions have been met, your Product will be repaired or replaced free of charge. Repair or replacement decisions are at the sole discretion of Horizon Hobby.

Non-Warranty Repairs

Should your repair not be covered by warranty the repair will be completed and payment will be required without notification or estimate of the expense unless the expense exceeds 50% of the retail purchase cost.

By submitting the item for repair you are agreeing to payment of the repair without notification. Repair estimates are available upon request. You must include this request with your repair. Non-warranty repair estimates will be billed a minimum of ½ hour of labor. In addition you will be billed for return freight. Please advise us of your preferred method of payment. Horizon accepts money orders and cashiers checks, as well as Visa, MasterCard, American Express, and Discover cards. If you choose to pay by credit card, please include your credit card number and expiration date. Any repair left unpaid or unclaimed after 90 days will be considered abandoned and will be disposed of accordingly. ***Please note: non-warranty repair is only available on electronics and model engines.***

Electronics and engines requiring inspection or repair should be shipped to the following address:

Horizon Service Center
4105 Fieldstone Road
Champaign, Illinois 61822

All other Products requiring warranty inspection or repair should be shipped to the following address:

Horizon Product Support
4105 Fieldstone Road
Champaign, Illinois 61822

Please call 877-504-0233 with any questions or concerns regarding this product or warranty.

Safety, Precautions, and Warnings

As the user of this product, you are solely responsible for operating it in a manner that does not endanger yourself and others or result in damage to the product or the property of others.

Carefully follow the directions and warnings for this and any optional support equipment (chargers, rechargeable battery packs, etc.) that you use.

This model is controlled by a radio signal that is subject to interference from many sources outside your control. This interference can cause momentary loss of control so it is necessary to always keep a safe distance in all directions around your model, as this margin will help to avoid collisions or injury.

- Always operate your model in an open area away from cars, traffic, or people.
- Avoid operating your model in the street where injury or damage can occur.
- Never operate the model out into the street or populated areas for any reason.
- Never operate your model with low transmitter batteries.
- Carefully follow the directions and warnings for this and any optional support equipment (chargers, rechargeable battery packs, etc.) that you use.
- Keep all chemicals, small parts and anything electrical out of the reach of children.
- Moisture causes damage to electronics. Avoid water exposure to all equipment not specifically designed and protected for this purpose.

Landing Gear Installation

Required Parts

Fuselage

Main landing gear

Wheel pant (L&R)

1 $\frac{3}{4}$ " (45mm) wheel (2)

4-40 x $\frac{3}{8}$ " machine screws (2)

#4 black washers (2)

4-40 nut (2)

4-40 locknut (2)

4-40 x 1" machine screw (2)

#4 steel washers (4)

2mm x 6mm wood screws (2)

Required Tools and Adhesives

Phillips screwdriver (small)

Needle-nose pliers

Nut driver: $\frac{1}{4}$ "

Hex wrench: $\frac{3}{32}$ "

Note: You may consider using a larger diameter wheel, such as $2\frac{1}{4}$ " (58mm) (EFLA224), if your flying site has rough terrain. By using a larger wheel, you will not be able to use the included wheel pants.

- 1. Place the landing gear onto the bottom of the fuselage. They will angle forward when installed in the correct direction. Attach with two 4-40 x $\frac{3}{8}$ " machine screws and two #4 black washers.

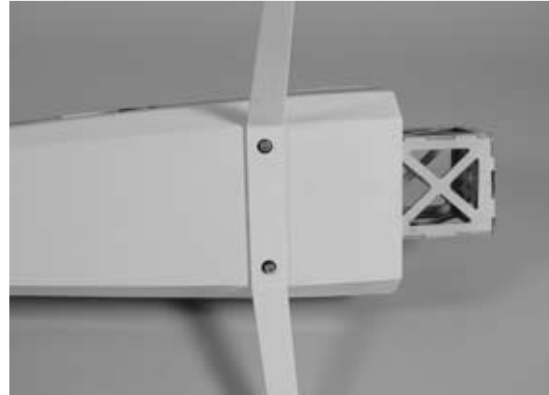

- ○ 2. Slide the 4-40 x 1" machine screw through one of the 1³/₄" wheels. Slide a #4 steel washer so it fits against the wheel. Next secure a 4-40 nut against the washer. Make sure the wheel still spins freely. Slide a second #4 steel washer onto the bolt. This washer will fit inside the wheel pant.



- ○ 3. Fit the assembly in Step 2 into the wheel pant and insert the bolt into the landing gear. With the fuselage level to the work surface, rotate the wheel pant so it is also level to your work surface and secure the pant to the landing gear with a 2mm x 6mm wood screw. Secure the bolt with a 4-40 locknut while using needle-nose pliers to hold the head of the bolt inside the pant.



- 4. Repeat Steps 2 and 3 for the remaining wheel and wheel pant.

Outrunner Motor Installation

Required Parts

Fuselage
Brushless motor
4-40 x 3/8" machine screw (4)

Required Tools and Adhesives

Hex wrench: 3/32"
Screwdriver (Phillips #0)

Note: This section covers the installation of the recommended Park 480 Outrunner motor. The holes in the firewall match the mounting pattern of the X-mount.

- 1. Attach the supplied aluminum motor X-mount to the motor using the screws provided with the motor. The wider section of the mount will be positioned toward the motor wires.



- 2. Attach the Outrunner motor to the front of the firewall using four 4-40 x 3/8" machine screws.

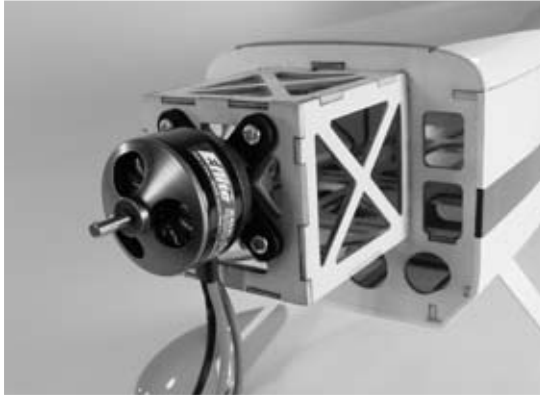

Cowling Installation

Required Parts

- Fuselage w/motor installed
- Cowling
- 2mm x 8mm wood screw (4)
- Propeller
- Spinner
- Prop adapter (for outrunner motor)
- Electronic speed control

Required Tools and Adhesives

- Screwdriver (Phillips #0)
- Cardstock
- Masking tape
- Hook and loop material
- Drill
- Drill bit; 1/16" (1.5mm), 5/64" (2mm)

Important Information About Your Brushless ESC

Make sure your ESC brake is programmed to Off. Also, be sure to use an ESC with the proper 9V cutoff when using 3-cell Li-Po packs, or 6V cutoff when using 2-cell Li-Po packs.

Important Information About Your Propeller

It is also very important to check to be sure the propeller is balanced before installing onto the shaft. An unbalanced propeller may strip the gears or cause poor flight characteristics.

- 1. Solder any connectors to the speed control to connect to the motor battery and motor if necessary. Connect the ESC to the motor and secure it to the inside of the fuselage using hook and loop material. Actual ESC location may vary but proper air flow and cooling is important.

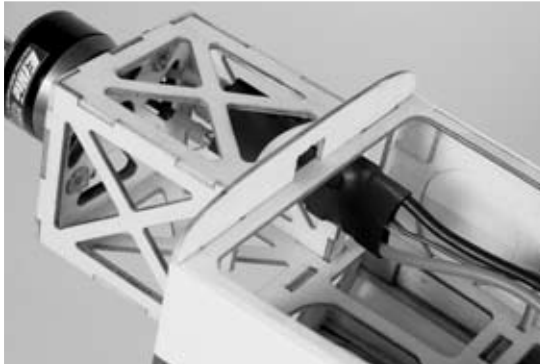

- 2. Connect the speed control to the radio system and motor battery. Check that the motor is rotating in the correct direction. It will rotate counterclockwise when viewed from the front of the aircraft. Use the instructions with your speed control to correct a motor that is operating in the wrong direction.
- 3. Tape small pieces of cardstock to the fuselage to indicate the locations of the cowl mounting tabs at the front of the fuselage.

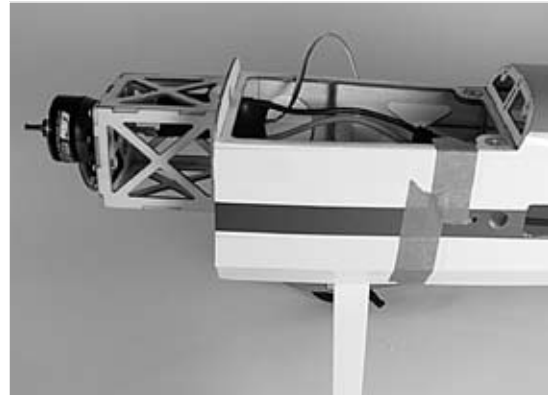

- 4. Slide the cowling onto the fuselage. Install the propeller adapter onto the Outrunner shaft. You may need to ream out the hole on your prop hub to fit the prop adapter shaft at this point. Slide the propeller onto the prop adapter shaft. The spinner backplate and spacers may need to be enlarged as well to fit the prop adapter. Slide the spinner backplate and any needed spacers onto the prop adapter shaft. Secure the propeller using the prop adapter spinner and be sure it is secure and tight.



Note: Make sure to check the balance of the propeller after enlarging the hole in the propeller.

- 5. Position the cowl so it is around $1/16$ "– $1/8$ " (1.5mm–3mm) from the spinner backplate. Use the cardstock to drill four $1/16$ " (1.5mm) holes through the cowl into the cowl mounting tabs in the fuselage.

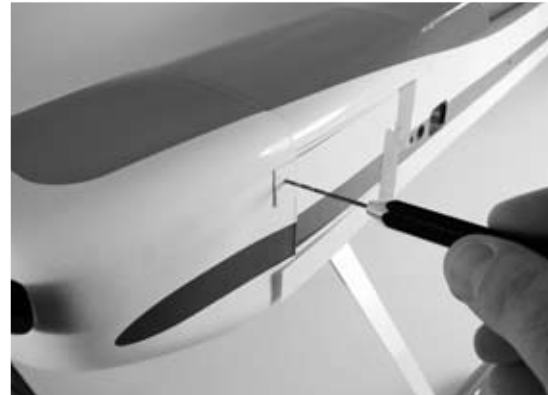

6. Enlarge the holes in the cowl using a $5/64$ " (2mm) drill bit. Secure the cowl using four 2mm x 8mm sheet metal screws. Snap the spinner cone onto the spinner backplate once the cowl is secure.

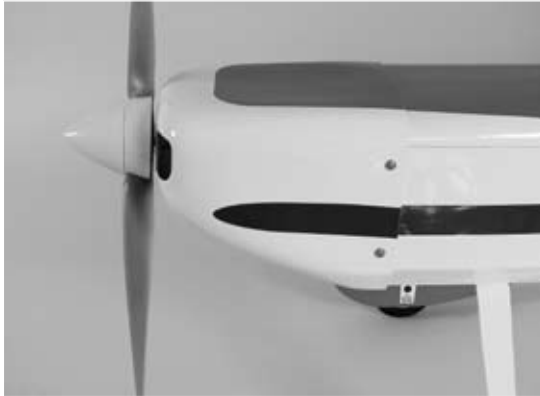

Hint: Use thin CA to harden the holes drilled into the cowl mounting tabs. This will help to prevent the screws from vibrating loose in flight.

Aileron Hinging

Required Parts

Wing (left and right)
Aileron (left and right)
CA hinges (8)

Required Tools and Adhesives

T-pins Thin CA
Drill Paper towel
Drill bit: 1/16" (1.5mm)

- ○ 1. Locate the positions for the hinges. Drill a 1/16" (2mm) hole in the center of each slot of both the wing and aileron. This creates a tunnel for the CA, allowing the CA to penetrate into the hinge better, bonding the hinges more securely.

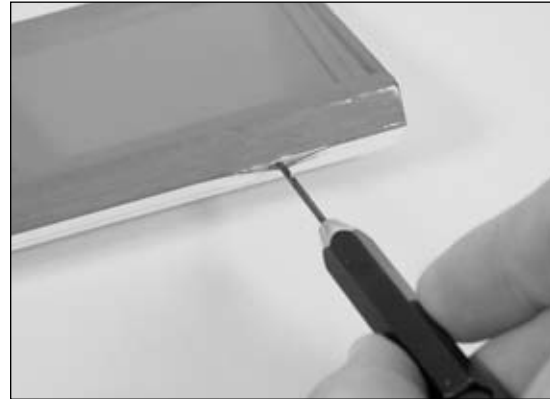

- ○ 2. Slide three hinges into the slits in the aileron. Center the slot in the hinge with the hole drilled in Step 1. Place a T-pin in each hinge to prevent it from being pushed into the wing when installing the aileron.

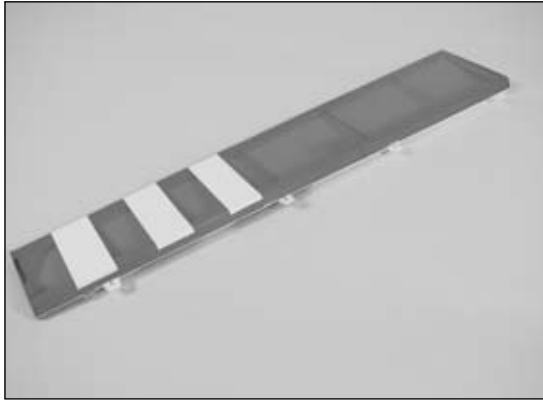

Note: Do not use CA accelerator during the hinging process. The CA must be allowed to soak into the hinge to provide the best bond. Using accelerator will not provide enough time for this process.

- ○ 3. Slide the aileron into position. Check to make sure it can move without interference at the wing root and wing tip. Remove the T-pins and apply Thin CA to each hinge. Make sure the hinge is fully saturated with CA. Use a paper towel to clean up any excess CA from the wing and aileron. Make sure to apply CA to both sides of the hinge.



- ○ 4. Firmly grasp the wing and aileron and gently pull on the aileron to ensure the hinges are secure and cannot be pulled apart. Use caution when gripping the wing and aileron to avoid crushing the structure.

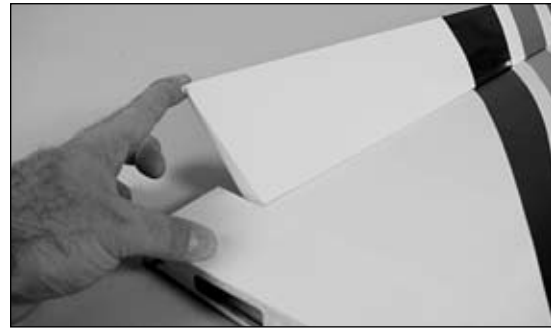

- ○ 5. Work the aileron up and down several times to work in the hinges and check for proper movement.

- 6. Repeat Steps 1 through 5 for the remaining aileron.

Aileron Servos and Linkages

Required Parts

- Wing panel (right and left)
- Micro control connector (2)
- 2mm x 4mm screw (2)
- 4" (100mm) pushrod (2)
- Control horn and backplate (2)
- Servos: S75 Sub-micro servo (EFLRS75) (2)

Required Tools and Adhesives

- Hobby knife
- 6-minute epoxy
- 6" (150mm) servo extension (2)
- String
- Phillips screwdriver (small)

- 1. Attach a 6" (150mm) servo extension. Use string to secure the servo lead and extension to prevent them from unplugging in flight.

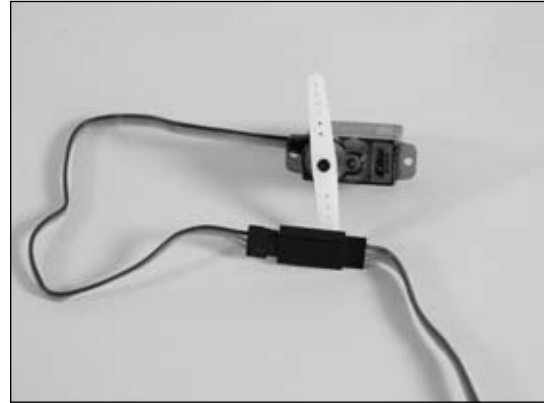

Note: We suggest using the long 3D servo arms for the Mini FuntanaX. Replace all existing arms before installing the servos.

- ○ 2. Place the servo in the wing. Guide the servo lead out through the opening at the wing root.

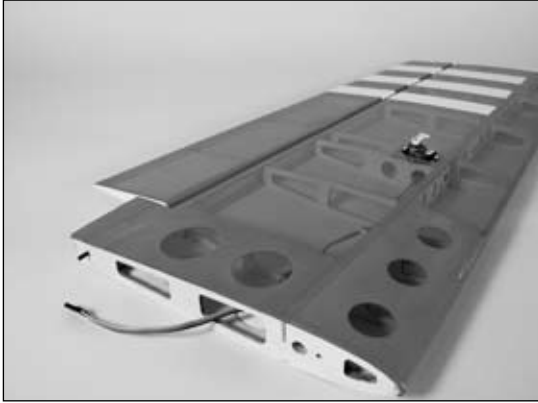

- ○ 3. Secure the aileron servo using the screws provided with the servo.

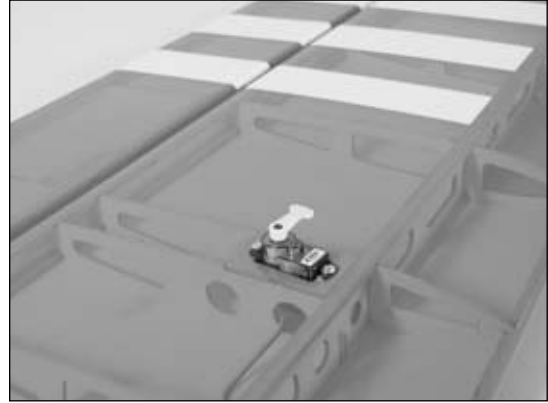

- ○ 4. Use a hobby knife to enlarge the inboard hole in the control horn to fit the 4" (100mm) long aileron pushrod wire.

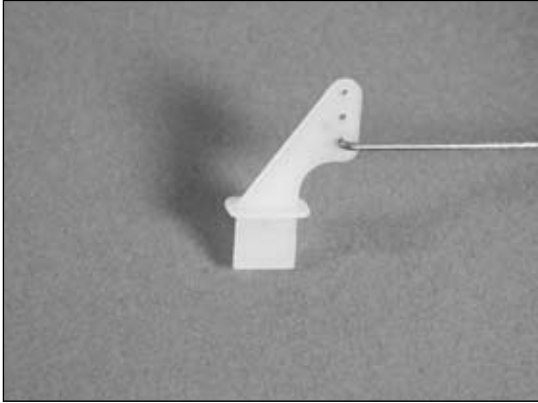

- 5. Repeat Steps 1 through 4 for the other wing panel.

- 6. Use 6-minute epoxy to attach the control horn to the aileron. Attach the control horns for both the right and left ailerons at this time.

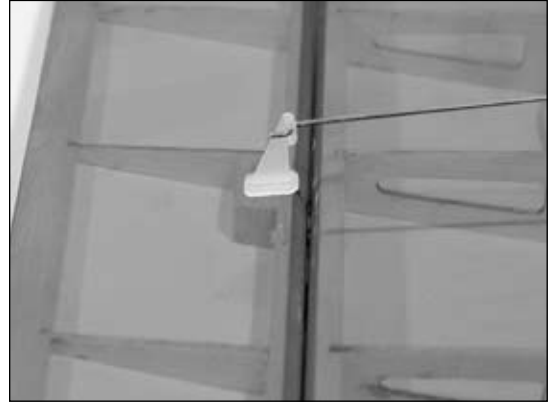

- 7. Attach the micro control connector to both servo arms. Be sure to use the included retainer to secure the micro control connector to the servo arms.

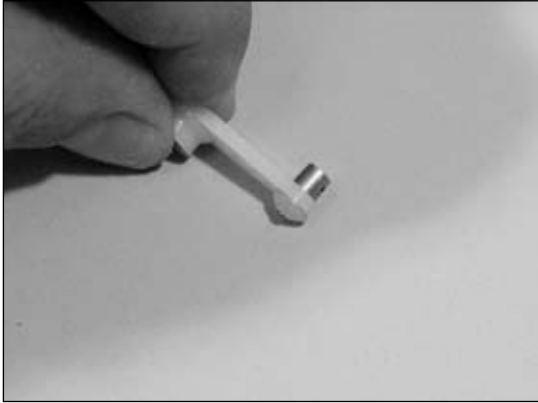

Note: Use the long 3D servo arms included with your servos to provide the greatest amount of throw.

- 8. Turn on the radio system and center the aileron trim and stick. Make sure the aileron servo is operating properly using the transmitter. Slide the pushrod wire through the micro connector. Install the servo arm 90-degrees to the servo. Center the aileron, and secure the position of the wire using the 2mm x 4mm screw and a Phillips screwdriver.

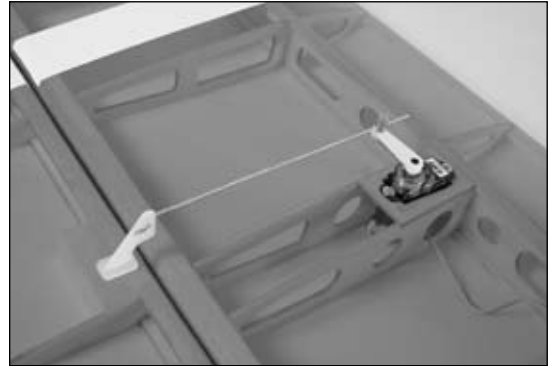

Wing Installation

Required Parts

Fuselage Wing (right and left)
Wing tube #4 washer (silver) (2)
4-40 x 1/2" machine screw (2)
Wing fairing (2)
Fairing spring

Required Tools and Adhesives

Hex wrench: 3/32"
6-minute epoxy Pliers

- 1. Slide the wing tube into a wing panel.

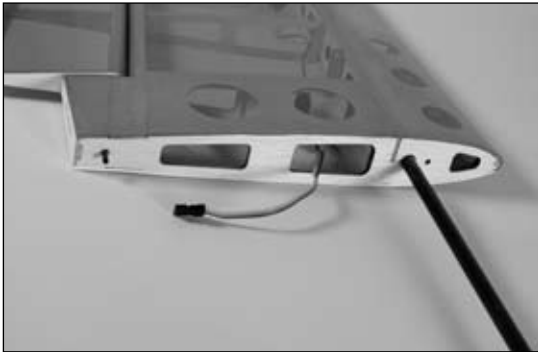

- 2. Remove the hatch from the fuselage. Slide the wing panel with tube into position on the fuselage.

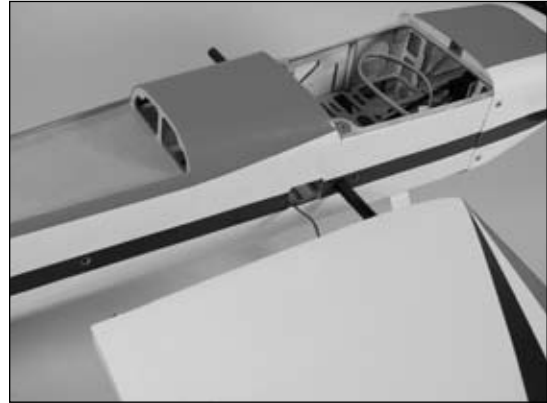

- ○ 3. Slide the remaining wing panel into position. Secure the panels using 4-40 x 1/2" machine screws with #4 washers (silver) using a 3/32" hex wrench.



- ○ 4. Test fit the wing fairing (filets) into position against the wing. You may need to loosen the screw holding the wing in place to install the fairing. Installing the fairing now will guarantee that it lines up correctly with the holes in the fuselage.

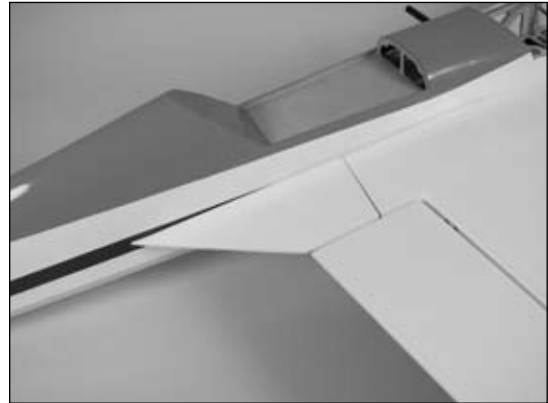

- ○ 5. Use 6-minute epoxy to glue the fairing to the wing. Make sure not to get glue on the fuselage. Use tape to hold the fairing tight against the wing while the epoxy cures.

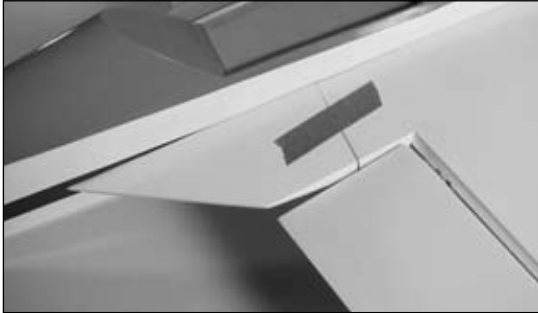

Note: The fairing may not fit tight against the fuselage at this time. This will be addressed once both fairings have been installed.

- ○ 6. Repeat Steps 3 through 5 for the remaining wing panel and fairing.
- 7. Secure the fairings together inside the fuselage using the fairing spring and pliers.



Stabilizer and Elevator

Required Parts

Fuselage w/wing installed
Stabilizer Elevator
CA hinge (4)

Required Tools and Adhesives

Hobby knife Felt-tipped pen
Ruler T-pins
Thin CA

- 1. Hinge the elevator and stabilizer, using the same process as described in Aileron Hinging. Use 6 hinges for this process.

- 2. Position the stabilizer into the slot in the aft end of the fuselage. Check that the elevators are an equal distance from the fuselage.



- 3. Measure from the stab tip to the wing tip. Adjust the stab until the measurements are equal.

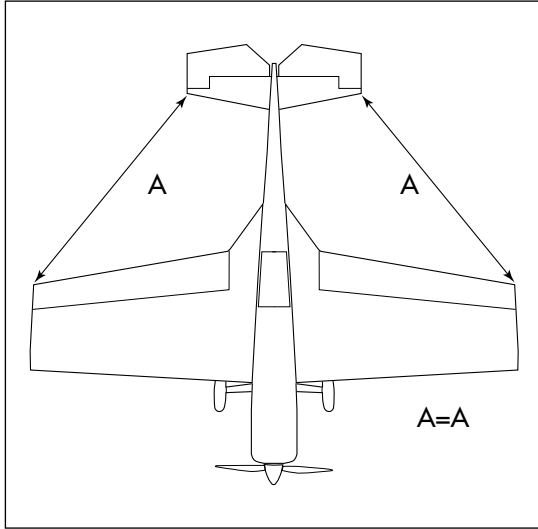

- 4. View the airframe from the rear and make sure the wing and stab are parallel. If not, lightly sand the stab saddle until they are.

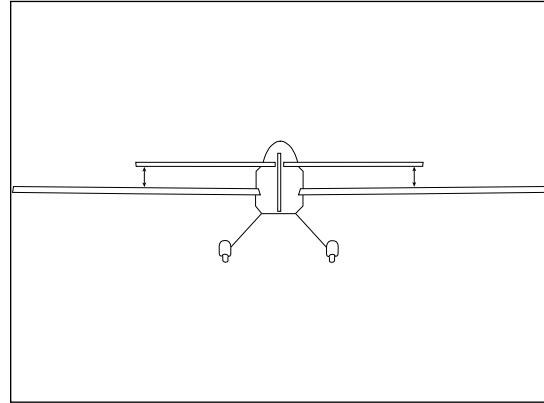

- 5. Double-check the adjustments from Steps 1 through 3. Use a felt-tipped pen to trace the outline of the fuselage onto the top and bottom of the stabilizer.

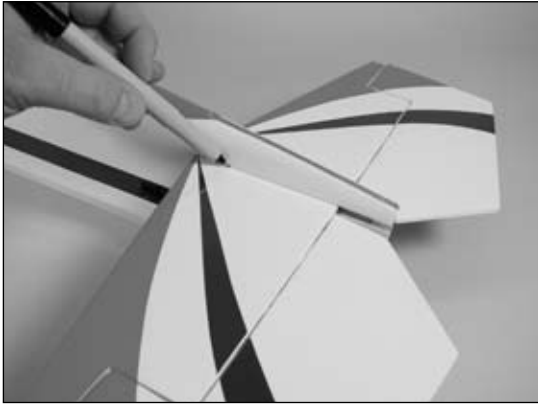

- 6. Use a sharp hobby knife to cut the covering slightly inside the lines drawn. Be very careful not to cut into the underlying wood, as this will weaken the stab and cause it to fail in flight.

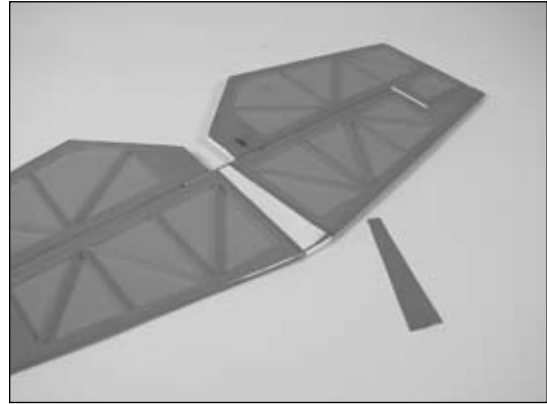

Note: You can use a soldering iron instead of a knife. This will eliminate the chances of cutting into the wood.

- 7. Slide the stab and elevator back into position. Again, check the alignment and make sure everything lines up. Wick Thin CA into the joint between the fuselage and stabilizer. Make sure to glue both top and bottom. Do not use accelerator— to allow the CA to wick in as far as possible, providing the best bond possible.

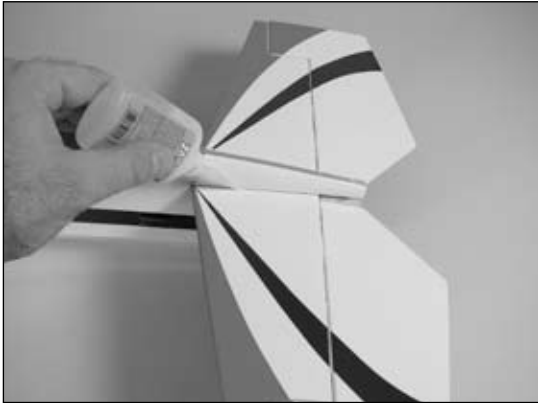

Rudder and Fin

Required Parts

Fuselage	Rudder
Fin	CA hinge (3)

Required Tools and Adhesives

Hobby knife	Thin CA
Felt-tipped pen	Square
6-minute epoxy	Medium grit sandpaper

- 1. Roughen the tail wheel assembly using medium grit sandpaper. Use 6-minute epoxy to glue the tail wheel assembly into the rudder.

 - 2. Hinge the rudder and fin, using the same process as described in Aileron Hinging. Use 3 hinges for this process.
- 2. Place the fin in position on the fuselage. Trace the outline of the fuselage onto both sides of the fin.



- 3. Remove the covering from the bottom of the fin using the same technique used for the stabilizer.



- 4. Position the fin back onto the fuselage. Use a square to check the alignment between the fin and stabilizer. Lightly sand the bottom of the fin until the alignment is correct.

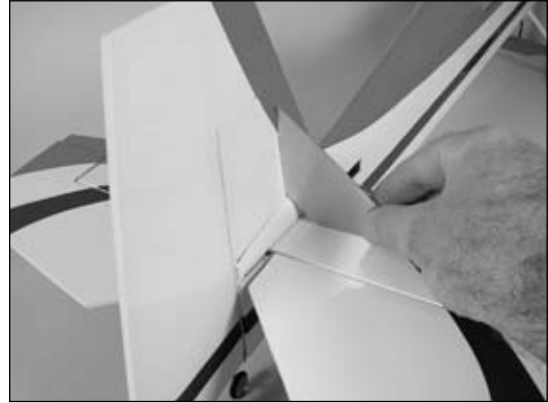

- 5. Use thin CA to glue the fin to the fuselage.



Rudder and Elevator Servos

Required Parts

Fuselage

Micro control horn w/backplate (2)

5³/₄" (145mm) pushrod wire

2mm x 4mm screw (2)

4¹/₂" (115mm) pushrod wire

Micro control connector w/retainer (2)

Servo (2)

18" (457mm) servo extension (2)

6¹/₂" carbon rod (2)

6¹/₂" carbon rod (2)

Required Tools and Adhesives

Phillips screwdriver (small)

Hobby knife

6-minute epoxy

- 1. Secure a 18" (457mm) servo extension to the servo. Mount the elevator servo using the hardware provided with the servo.



- 2. Use a hobby knife to enlarge the inboard hole in one of the remaining control horns. Attach the 4 1/2" (115mm) pushrod wire to the control horn.

- ○ 3. Attach the micro control horn to the elevator using the control horn backplate and 6-minute epoxy.



- ○ 4. Install the micro control connector onto the elevator servo arm. Pass the elevator pushrod wire through the connector. With the radio on and elevator trim centered, center the elevator. Secure the elevator pushrod wire using the 2mm x 4mm screw and a small Phillips screwdriver.



- 5. Repeat Steps 1 through 4 for the rudder servo and linkage using the $5\frac{3}{4}$ " (145mm) pushrod wire.

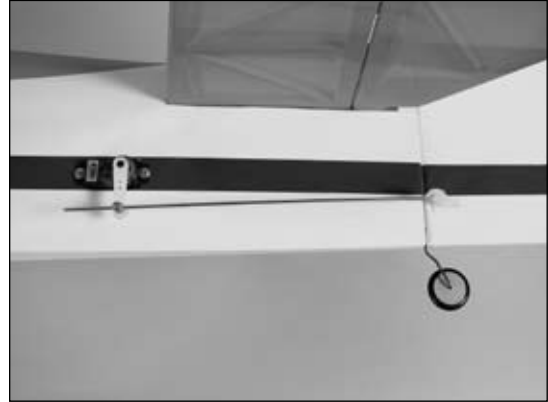

- 6. Attach the carbon stabilizer supports between the fuselage and stabilizer. Make notches in the stabilizer and fuselage for the rods to rest in. Secure the rods using 6-minute epoxy.

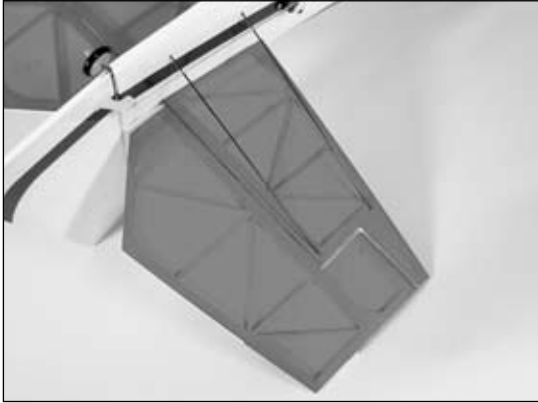

Note: Make sure the rods are positioned so they don't interfere with the operation of the rudder and elevator linkages.

Final Assembly

Required Parts

Fuselage
Wing
Canopy
Receiver
Battery
Battery hatch
4-40 x 1" socket head bolt (2)
#4 washer (2)
Hook and loop tape
Hook and loop strap

Required Tools and Adhesives

Hex wrench: 3/32"
Felt-tipped pen
Canopy glue

- 1. Plug in the elevator and rudder servos and ESC into the receiver. Mount the receiver to the inside of the fuselage using hook and loop material. Route the antenna wire through the bottom of the fuselage to the rear, or as directed by your radio instruction manual.



Note: Do not cut or change the length of the antenna wire, as this will reduce the range of your radio system.

- 2. Place the canopy into position on the fuselage. Use a felt-tipped pen to trace the outline of the canopy onto the fuselage.

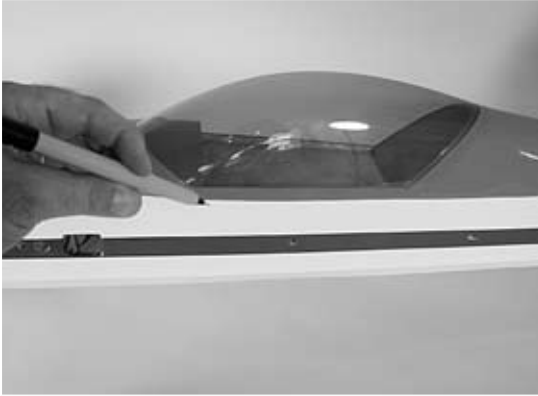

- 3. Use medium grit sandpaper to roughen the covering 1/8" (3mm) inside the line drawn. Also roughen the outside 1/8" (3mm) of the canopy. Clean the sanded areas using a paper towel and rubbing alcohol.

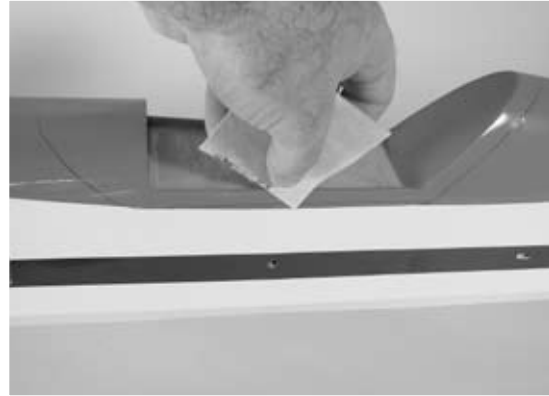

- 4. Use Formula 560 canopy glue to glue the canopy to the fuselage. Use masking tape to hold the canopy in position until the glue fully cures.

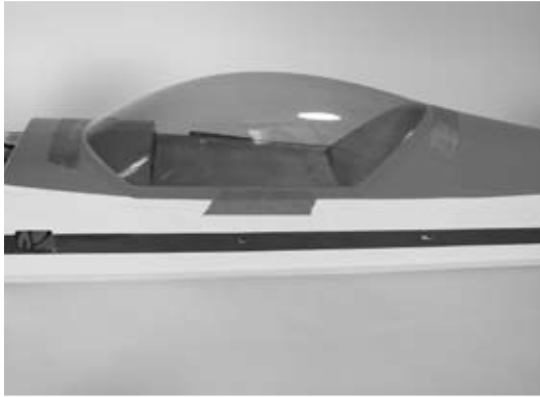

- 5. With the aircraft fully assembled, install the battery into the battery compartment. Secure the battery using the hook and loop tape and a hook and loop strap.

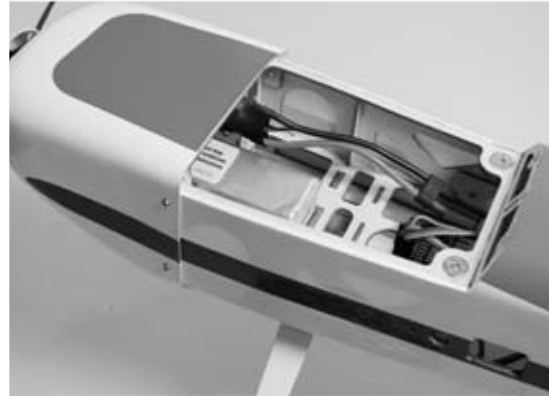

Note: Place a piece of hook and loop tape on the bottom of the battery and on the fuselage where the battery rests. This will keep the battery from shifting forward or backward during extreme maneuvers.

- 6. Install the battery hatch to the top of the fuselage. The magnet will hold the battery hatch in place.



- 7. Attach the optional side force generators (if you wish) to the wing tips using four 4-40 x 1/2" socket head screws. Add the plywood disks between the side force generators and the wing tip to prevent the aileron from rubbing against the side force generator.



Note: The side force generators can be removed in a few seconds. Try your Mini FuntanaX with and without them to decide which setup suits your flying style best.

Control Throws

- 1. Turn on the transmitter and receiver of your Mini FuntanaX. Check the movement of the rudder using the transmitter. When the stick is moved right, the rudder should also move right. Reverse the direction of the servo at the transmitter if necessary.
- 2. Check the movement of the elevator with the radio system. Moving the elevator stick down will make the airplane elevator move up.
- 3. Use a ruler to adjust the throw of the elevator, ailerons and rudder. Adjust the position of the pushrod at the control horn to achieve the following measurements when moving the sticks to their endpoints

	Low rate (U/D)	High Rate (U/D)
Elevator:	3/4" (19mm)	2 ⁵ / ₁₆ " (58mm)
Ailerons:	1" (25mm)	1 ⁷ / ₈ " (48mm)
Rudder:	1 ³ / ₄ " (95mm)	2 ³ / ₄ " (95mm)

Center of Gravity

An important part of preparing the aircraft for flight is properly balancing the model.

Caution: Do not inadvertently skip this step!

The recommended Center of Gravity (CG) location for the Mini FuntanaX is $3\frac{3}{4}$ " (95mm) behind the leading edge of the wing against the fuselage.



Range Test Your Radio

- 1. Before each flying session, be sure to range check your radio. This is accomplished by turning on your transmitter with the antenna collapsed. Turn on the receiver in your airplane. With your airplane on the ground and the engine running, you should be able to walk 30 paces (approximately 100 feet) away from your airplane and still have complete control of all functions.
- 2. Double-check that all controls (aileron, elevator, rudder and throttle) move in the correct direction.
- 3. Be sure that your transmitter batteries are fully charged, per the instructions included with your radio.

If not, don't attempt to fly! Have your radio equipment checked out by the manufacturer.

Preflight

Check Your Radio

Before going to the field, be sure that your batteries are fully charged per the instructions included with your radio. Charge both the transmitter and receiver pack for your airplane. Use the recommended charger supplied with your particular radio system, following the instructions provided with the radio. In most cases, the radio should be charged the night before going out flying.

Before each flying session, be sure to range check your radio. See your radio manual for the recommended range and instructions for your radio system. Each radio manufacturer specifies different procedures for their radio systems. Next, start the motor. With the model securely anchored, check the range again. The range test should not be significantly affected. If it is, don't attempt to fly! Have your radio equipment checked out by the manufacturer.

Note: Keep loose items that can get entangled in the propeller away from the prop. These include loose clothing, or other objects such as pencils and screwdrivers. Especially keep your hands away from the propeller.

Double-check that all controls (aileron, elevator, rudder and throttle) move in the correct direction.

Check the radio installation and make sure all the control surfaces are moving correctly (i.e. the correct direction and with the recommended throws). Test run the motor and make sure it transitions smoothly from off to full throttle and back. Also ensure the engine is installed according to the manufacturer's instructions, and it will operate consistently.

Check all the control horns, servo horns, and clevises to make sure they are secure and in good condition. Replace any items that would be considered questionable. Failure of any of these components in flight would mean the loss of your aircraft.

Flying Your Mini FuntanaX

Once you have finish the assembly of your Mini FuntanaX and have verified the center of gravity, you are ready to go. Check all the flight controls to ensure they are moving the in the correct direction and giving you the amount of throw you want. What we have listed in the high rates is enough to 3D the Mini FuntanaX with ease. Once at your park, you will find the steerable tailwheel makes taxiing of the Mini FuntanaX very easy. Apply power and you should be in the air in less than 50 feet. Trim the model out for level flight and check the feel of the controls. You will find the Mini FuntanaX has very light feel on the controls and is capable of anything you want to put it through. Flying high alpha is very easy and you will find the model exhibits very nice control authority in all respects. Rolls

are very crisp and precise on either rate. Landing the Mini FuntanaX is as easy as reducing power in the downwind and establishing a gentle descent rate as you turn from base to final. Once on final approach, adjust the power as necessary to determine your touchdown point. Apply a small amount of up elevator as you slow down and begin to approach the ground. The Mini FuntanaX likes to be set down in a three point attitude when landing. You will find the model behaves very well at slow speeds and lands very slowly as well. Flight times of better than 10 minutes are common with the Park 480 outrunner and a 2100 Li-Po battery.

We hope you enjoy the new Mini FuntanaX as much as we do, happy landings.

2006 Official AMA National Model Aircraft Safety Code

GENERAL

- 1) I will not fly my model aircraft in sanctioned events, air shows or model flying demonstrations until it has been proven to be airworthy by having been previously, successfully flight tested.
- 2) I will not fly my model higher than approximately 400 feet within 3 miles of an airport without notifying the airport operator. I will give right-of-way and avoid flying in the proximity of full-scale aircraft. Where necessary, an observer shall be utilized to supervise flying to avoid having models fly in the proximity of full-scale aircraft.
- 3) Where established, I will abide by the safety rules for the flying site I use, and I will not willfully or deliberately fly my models in a careless, reckless and/or dangerous manner.
- 4) The maximum takeoff weight of a model is 55 pounds, except models flown under Experimental Aircraft rules.
- 5) I will not fly my model unless it is identified with my name and address or AMA number on or in the model. (This does not apply to models while being flown indoors.)

6) I will not operate models with metal-bladed propellers or with gaseous boosts, in which gases other than air enter their internal combustion engine(s); nor will I operate models with extremely hazardous fuels such as those containing tetranitromethane or hydrazine.

RADIO CONTROL

- 1) I will have completed a successful radio equipment ground range check before the first flight of a new or repaired model.
- 2) I will not fly my model aircraft in the presence of spectators until I become a qualified flier, unless assisted by an experienced helper.
- 3) At all flying sites a straight or curved line(s) must be established in front of which all flying takes place with the other side for spectators. Only personnel involved with flying the aircraft are allowed at or in front of the flight line. Intentional flying behind the flight line is prohibited.

2006 Official AMA National Model Aircraft Safety Code

4) I will operate my model using only radio control frequencies currently allowed by the Federal Communications Commission. (Only properly licensed Amateurs are authorized to operate equipment on Amateur Band frequencies.)

5) Flying sites separated by three miles or more are considered safe from site-to-site interference, even when both sites use the same frequencies. Any circumstances under three miles separation require a frequency management arrangement, which may be either an allocation of specific frequencies for each site or testing to determine that freedom from interference exists. Allocation plans or interference test reports shall be signed by the parties involved and provided to AMA Headquarters.

Documents of agreement and reports may exist between (1) two or more AMA Chartered Clubs, (2) AMA clubs and individual AMA members not associated with AMA Clubs, or (3) two or more individual AMA members.

6) For Combat, distance between combat engagement line and spectator line will be 500 feet per cubic inch of engine displacement. (Example: .40 engine = 200 feet.); electric motors will be based on equivalent combustion engine size. Additional safety requirements will be per the RC Combat section of the current Competition Regulations.

7) At air shows or model flying demonstrations, a single straight line must be established, one side of which is for flying, with the other side for spectators.

8) With the exception of events flown under AMA Competition rules, after launch, except for pilots or helpers being used, no powered model may be flown closer than 25 feet to any person.

9) Under no circumstances may a pilot or other person touch a powered model in flight.

E-flite[®]

HORIZON
H O B B Y

© 2006 Horizon Hobby, Inc.
4105 Fieldstone Road
Champaign, Illinois 61822
(877) 504-0233
horizonhobby.com
E-fliteRC.com