

Pete'n Poke™

Sport 40

INSTRUCTION MANUAL



Wing Span - 59.5 in [1510mm]
Wing Area - 809 sq in [52.2 sq dm]
Weight - 5 lb 12 oz [2610 g]
Wing Loading - 16.4 oz/sq ft [50 g/sq dm]
Fuse Length - 47 in [1195mm]



WARRANTY

Great Planes® Model Manufacturing Co. guarantees this kit to be free from defects in both material and workmanship at the date of purchase. This warranty does not cover any component parts damaged by use or modification. **In no case shall Great Planes' liability exceed the original cost of the purchased kit.** Further, Great Planes reserves the right to change or modify this warranty without notice.

In that Great Planes has no control over the final assembly or material used for final assembly, no liability shall be assumed nor accepted for any damage resulting from the use by the user of the final user-assembled product. By the act of using the user-assembled product, the user accepts all resulting liability.

If the buyer is not prepared to accept the liability associated with the use of this product, the buyer is advised to return this kit immediately in new and unused condition to the place of purchase.

READ THROUGH THIS MANUAL BEFORE STARTING CONSTRUCTION. IT CONTAINS IMPORTANT WARNINGS AND INSTRUCTIONS CONCERNING THE ASSEMBLY AND USE OF THIS MODEL.



P.O. Box 788 Urbana, IL 61803 (217) 398-8970
WWW.GREATPLANES.COM

TABLE OF CONTENTS

INTRODUCTION	2
PRECAUTIONS	2
ADDITIONAL ITEMS REQUIRED	3
Hardware and Accessories	3
Adhesives and Building Supplies	3
Optional Supplies and Tools	3
IMPORTANT BUILDING NOTES	4
Types of Wood	5
GET READY TO BUILD	5
METRIC CONVERSIONS	5
METRIC/INCH RULER	5
DIE-CUT PATTERNS	6 & 7
BUILD THE TAIL SURFACES	8
Build the Fin and Rudder	8
Build the Stab and Elevators	8
Hinge the Tail Surfaces	9
BUILD THE WING	11
Build the Center-Section	11
Finish the Center-Section	14
Build the Outer Panels	15
Join the Wing Panels	17
Build the Ailerons	17
Hook Up the Ailerons	18
Finish the Wing	19
BUILD THE FUSELAGE	19
Build the Fuselage Sides and Top	19
Frame the Bottom of the Fuselage	20
Join the Fin to the Fuselage	23
Frame the Top of the Fuselage	24
Make the Main Wing Struts	25
Mount the Engine	27
Connect the Pushrods	28
Sheet the Top of the Fuselage	28
Mount the Landing Gear	29
Join the Main Wing Struts	30
FINAL CONSTRUCTION	33
Build the Static Wing Struts	33
Prepare the Model for Covering	33
Cover the Model	34
Glue the Main Wing Struts into Position	34
Finish the Cockpits	34
Join the Control Surfaces	35
Hook Up the Controls	35
GET THE MODEL READY TO FLY	36
Check the Control Directions	36
Set the Control Throws	37
Balance the Model (C.G.)	37
Balance the Model Laterally	38
PREFLIGHT	38
Identify Your Model	38
Charge the Batteries	38
Balance Propeller	38
Ground Check	38
Range Check	39
ENGINE SAFETY PRECAUTIONS	39
AMA SAFETY CODE (excerpt)	39
General	39
Radio Control	39
CHECK LIST	40
FLYING	40
Takeoff	40
Flight	41
Landing	41
2-VIEW DRAWING	Back Cover Page
FUSE & WING PLANS	Center Pull-Out Section

INTRODUCTION

Congratulations and thank you for purchasing the Great Planes Pete 'n Poke Sport 40. The Pete 'n Poke is the third in a series of nostalgic-looking sport models from Great Planes that are intended to be simple to build and relaxing to fly. (The SlowPoke and SlowPoke Sport 40 precede the Pete 'n Poke.) The Pete 'n Poke isn't just for old-timers! Even the most contest-hardened veteran can use a laid-back day of flying, and the Pete 'n Poke is just the ticket! With its large-area parasol wing, this model is a breeze to fly—especially if you enjoy flying low and slow. We also gave the Pete 'n Poke a trim scheme that complements its classic lines, but of course you could design your own trim scheme too! We favor the Top Flite® MonoKote® film cream and sapphire blue featured on the kit box cover, but considered the same scheme in cream and red. Maybe you could give that one a try yourself. Send us a photo if you do!

PROTECT YOUR MODEL, YOURSELF & OTHERS...FOLLOW THESE IMPORTANT SAFETY PRECAUTIONS

1. Your Pete 'n Poke is not a toy, but rather a sophisticated, working model that functions very much like a full-size airplane. Because of its realistic performance, the Pete 'n Poke, if not assembled and operated correctly, could possibly cause injury to yourself or spectators and damage property.
2. You must build the plane according to the plan and instructions. Do not alter or modify the model, as doing so may result in an unsafe or unflyable model. In a few cases the plan and instructions may differ slightly from the photos. In those instances the plan and written instructions are correct.
3. You must take time to build straight, true and strong.
4. You must use an R/C radio system that is in first-class condition, and a correctly sized engine and components (fuel tank, wheels, etc.) throughout your building process.
5. You must properly install all R/C and other components so that the model operates properly on the ground and in the air.
6. You must check the operation of the model before every flight to insure that all equipment is operating and that the model has remained structurally sound. Be sure to check clevises or other connectors often and replace them if they show any signs of wear or fatigue.
7. If you are not already an experienced R/C pilot, you should fly the model only with the help of a competent, experienced R/C pilot.

Note: We, as the kit manufacturer, provide you with a top quality kit and great instructions, but ultimately the quality of your finished model depends on how you build it; therefore, we cannot in any way guarantee the performance of your completed model, and no representations are expressed or implied as to the performance or safety of your completed model.

Remember: Take your time and follow the instructions to end up with a well-built model that is straight and true.

Before starting to build, compare the parts in this kit with the Parts List, and note any missing parts. Also inspect all parts to make sure they are of acceptable quality. If any parts are missing, broken or defective, or if you have any questions about building or flying this airplane, please call us at (217) 398-8970, or e-mail us at productsupport@greatplanes.com. If you are contacting us for replacement parts, please be sure to provide the full kit name (Pete 'n Poke Sport 40) and the part numbers as listed in the Parts List.

You can also check our web site at www.greatplanes.com for the latest Pete 'n Poke Sport 40 updates.

If you're not already an Academy of Model Aeronautics (AMA) member, we strongly urge you to join. There are over 2,500 AMA chartered clubs across the country. Among other benefits, the AMA provides insurance to its members who fly at sanctioned sites and events. Additionally, training programs and instructors are available at AMA club sites to help you get started the right way. Contact the AMA at the address or toll-free phone number below:



Academy of Model Aeronautics
5151 East Memorial Drive
Muncie, IN 47302-9252
Tele. (800) 435-9262
Fax (765) 741-0057
Or via the Internet at:
<http://www.modelaircraft.org>

ADDITIONAL ITEMS REQUIRED

Hardware & Accessories

This is the list of hardware and accessories required to finish the Pete 'n Poke Sport 40. Order numbers are provided in parentheses for your convenience.

- 4-Channel radio with five servos
- .32 to .46 two-stroke engine *-or-*
- .40 to .52 four-stroke engine
- Propellers recommended by the engine manufacturer

- (2) Hobbico® 6" extension cords for aileron servos (HCAM2000)
- Futaba® AEC-13 Dual extension cord (FUTM4130)
- 10 oz. Fuel tank (GPMQ4104)
- Medium fuel tubing (GPMQ4131)
- (2) 3" Main wheels (GPMQ4225)
- 1" Tail wheel (GPMQ4241)
- (4) 3/16" Wheel collars (GPMQ4308)
- (1) 3/32" Wheel collars (GPMQ4302)
- 2-1/2" Spinner (white - GPMQ4520)
- (2) Rolls of covering film
- One or two 1/5 Scale pilots (WBRQ2477)
- R/C foam rubber (1/4" - HCAQ1000, or 1/2" - HCAQ1050)

Adhesives & Building Supplies

In addition to common household tools (screwdrivers, drill, etc.), this is the "short list" of the most important items required to build the Pete 'n Poke. *We recommend Great Planes Pro™ CA and Epoxy glue.*

- 2 oz. Thin Pro CA (GPMR6003)
- 2 oz. Medium Pro CA+ (GPMR6009)
- CA applicator tips (GPMR6033, qty. 5)
- 30-minute epoxy (GPMR6047)
- 3M 75 Repositionable spray adhesive (MMMR1900) *-or-*
- 3M 77 Super spray adhesive (MMMR1990)
- Cigarette lighter fluid (to remove spray adhesive)
- Hobby knife (HCAR0105)
- #11 blades (HCAR0211)
- Medium T-pins
- Great Planes Plan Protector (GPMR6167) or wax paper
- Drill bits: 1/16", 3/32", 1/8", 9/64" (or 1/8"), #8 (or 3/16"), 3/16", 1/4"
- #7 drill and 1/4-20 tap (GPMR8105)
- 36" Straightedge (HCAR0475)
- Sanding tools and sandpaper assortment

Optional Supplies & Tools

This is a list of optional tools and accessories mentioned in the manual that will help you build your Pete 'n Poke.

- Epoxy Brushes (GPMR8060)
- Mixing Sticks (GPMR8055)
- 6-Minute Epoxy (GPMR6045)
- Milled Fiberglass (GPMR6165)
- Microballoons (TOPR1090)
- CA accelerator (GPMR6034)
- R/C-56 Canopy Glue (JOZR5007)
- Rubbing Alcohol (for epoxy clean up)
- Great Planes Precision Hinge Marking Tool (GPMR4005)
- Non-elastic monofilament or Kevlar fishing line (for stab alignment)
- Builder's Triangle Set (HCAR0480) (for fin alignment)
- Great Planes Slot Machine™ Motorized Hinge Slotting Tool (GPMR4010)

- Masking Tape (TOPR8018)
- Small metal file
- Rotary tool such as Dremel® Moto-Tool®
- Rotary tool reinforced cut-off wheel (GPMR8020)
- Hobbico Servo Horn Drill (or a #48 drill bit)
- Curved-tip scissors for trimming the windshields (HCAR0667)
- Great Planes Dead Center™ Engine Mount Hole Locator (GPMR8130)
- Top Flite® Sealing Iron™ (TOPR2100)
- Top Flite Hot Sock™ iron cover (TOPR2175)
- Top Flite Trim Seal Tool™ (TOPR2200)
- Great Planes AccuThrow™ Deflection Gauge (for measuring control throws, GPMR2405)
- Great Planes CG Machine™ (GPMR2400)
- Top Flite Precision Magnetic Prop Balancer™ (TOPQ5700)
- Easy-Touch™ Bar Sanders (See following section on Bar Sanders)

IMPORTANT BUILDING NOTES

- There are two types of screws used in this kit:

Sheet metal screws are designated by a number and a length.

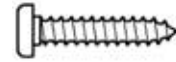

For example #6 x 3/4"

Machine screws are designated by a number, threads per inch, and a length.



For example 4-40 x 3/4"

This is a number four screw that is 3/4" long with forty threads per inch.

- When you see the term "**test fit**" in the instructions, it means that you should first position the part on the assembly **without using any glue**, then slightly modify or "custom fit" the part as necessary for the best fit.

- Whenever the term "**glue**" is written you should rely upon your experience to decide what type of glue to use. When a specific type of adhesive works best for that step, the instructions will make a recommendation.

- Whenever just "**epoxy**" is specified you may use **either** 30-minute epoxy **or** 6-minute epoxy. When 30-minute epoxy is **specified** it is **highly recommended** that you use only 30-minute (or 45-minute) epoxy because you will need the working time and/or the additional strength.

- **Photos** and **sketches** are placed **before** the step they refer to. Frequently you can study the photos following each step to get another view of the same parts.

- Use a single-edge razor blade to cut the balsa sticks when building the tail surfaces. Use T-pins to hold the sticks in position over the plan until it is completed and it's time to take the structure off the plan.

- For clarity, some assemblies are photographed off the plan, even though you should be building over the plan where indicated.



A flat, durable, easy to handle sanding tool is a necessity for building a well finished model. Great Planes makes a complete range of **Easy-Touch Bar Sanders** (patented) and replaceable **Easy-Touch Adhesive-backed Sandpaper**. While building the Pete 'n Poke we used two 5-1/2" Bar Sanders and two 11" Bar Sanders equipped with 80-grit and 150-grit Adhesive-backed Sandpaper.

Here's the complete list of Easy-Touch Bar Sanders and Adhesive Backed Sandpaper:

- 5-1/2" Bar Sander (GPMR6169)
- 11" Bar Sander (GPMR6170)
- 22" Bar Sander (GPMR6172)
- 33" Bar Sander (GPMR6174)
- 44" Bar Sander (GPMR6176)
- 11" Contour Multi-Sander (GPMR6190)

- 12' roll of Adhesive-backed 80-grit sandpaper (GPMR6180)
- 150-grit (GPMR6183)
- 180-grit (GPMR6184)
- 220-grit (GPMR6185)
- Assortment pack of 5-1/2" strips (GPMR6189)

We also use Top Flite 320-grit (TOPR8030, 4 sheets) and 400-grit (TOPR8032, 4 sheets) wet-or-dry sandpaper for finish sanding.

Types of Wood

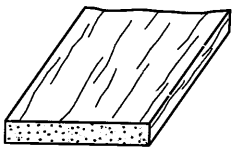

Balsa

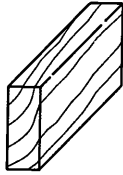

Basswood

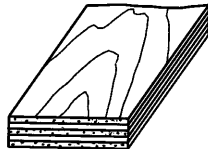

Plywood

GET READY TO BUILD

- ❑ 1. Unroll the plan sheets. Roll the plan sheets inside out to make them lie flat.
- ❑ 2. Remove all the parts from the box. As you do, determine the name of each part by comparing it with the plan and the parts list. Use a ballpoint pen (not a felt-tip pen) to lightly write the **name** or **size** on each piece so you can identify it later. Use the die-cut patterns on pages 6 & 7 to identify and mark the die-cut parts **before** you remove them from their die sheets. Many of the parts already have numbers stamped on them, but in some cases the numbers are located alongside the parts or only on the die drawings in the manual. You may remove all the die-cut parts from

their die sheets now or wait until you need them. If a part is difficult to remove, don't force it out but cut around it with a hobby knife and a #11 blade. After you remove the parts from their die sheets, lightly sand the edges to remove slivers or die-cutting irregularities. Save some of the larger scraps of wood.

- ❑ 3. As you identify and mark the parts, separate them into groups, such as **fuse** (fuselage), **wing**, and **tail**.

Metric Conversions

1/64" = .4mm	3/16" = 4.8mm	1" = 25.4mm	18" = 457.2mm
1/32" = .8mm	1/4" = 6.4mm	2" = 50.8mm	21" = 533.4mm
1/16" = 1.6mm	3/8" = 9.5mm	3" = 76.2mm	24" = 609.6mm
3/32" = 2.4mm	1/2" = 12.7mm	6" = 152.4mm	30" = 762mm
1/8" = 3.2mm	5/8" = 15.9mm	12" = 304.8mm	36" = 914.4mm
5/32" = 4mm	3/4" = 19mm	15" = 381mm	

To convert inches to millimeters, multiply inches by 25.4

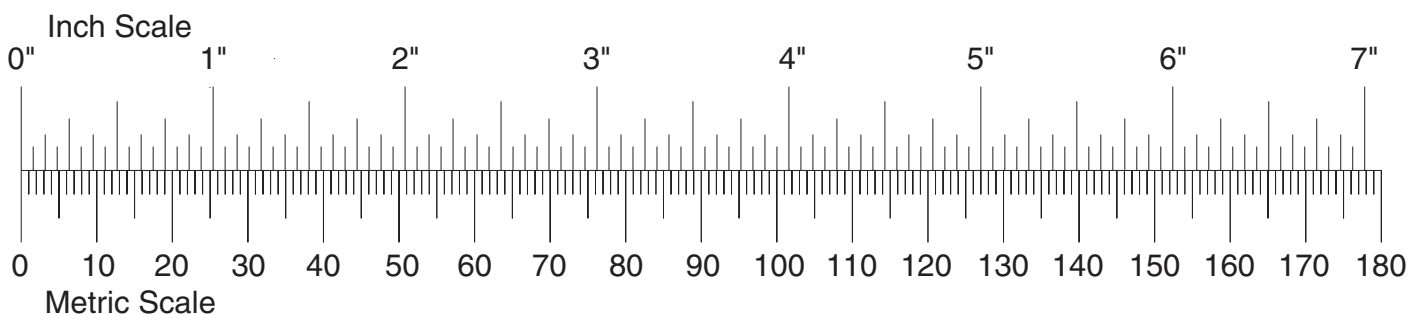

DIE-CUT PATTERNS

PNP4W03

2 PER KIT

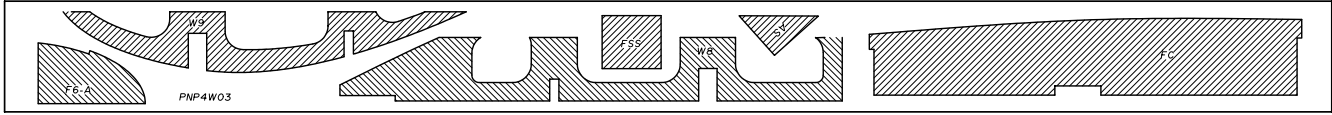

3/32" X 3" X 36" BALSA

PNP4W01

2 PER KIT

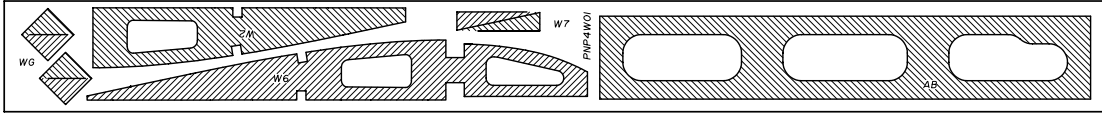

1/8" X 3" X 30" BALSA

PNP4F02

2 PER KIT

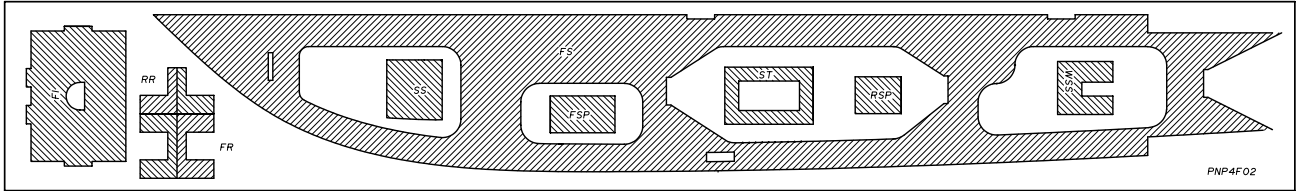

1/8" X 5-1/8" X 35" BALSA

PNP4F01

2 PER KIT

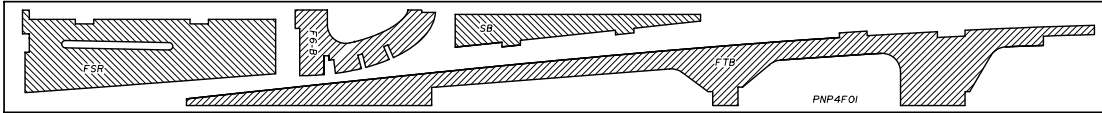

1/8" X 3" X 30" BALSA

PNP4W04

2 PER KIT

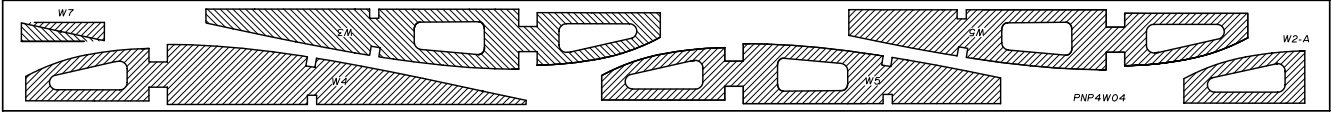

1/8" X 3" X 36" BALSA

PNP4W02

1 PER KIT

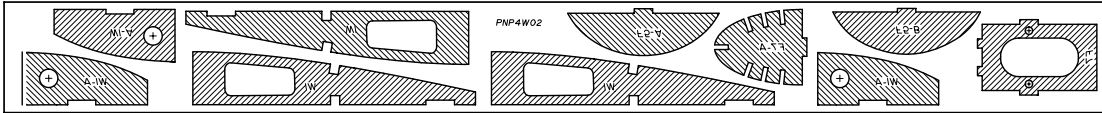

1/8" X 3" X 30"

PNP4R01

2 PER KIT

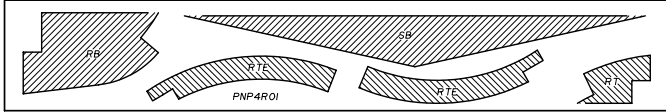

1/8" X 3" X 18" BALSA

PNP4F05

1 PER KIT

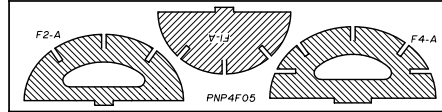

1/8" X 3" X 12" BALSA

DIE-CUT PATTERNS

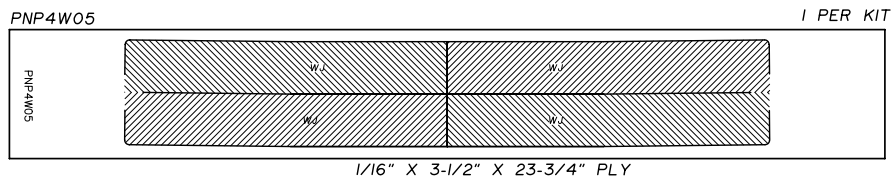
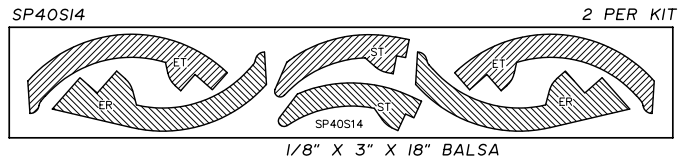
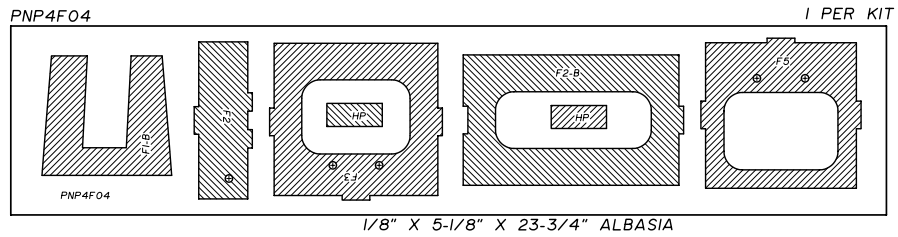
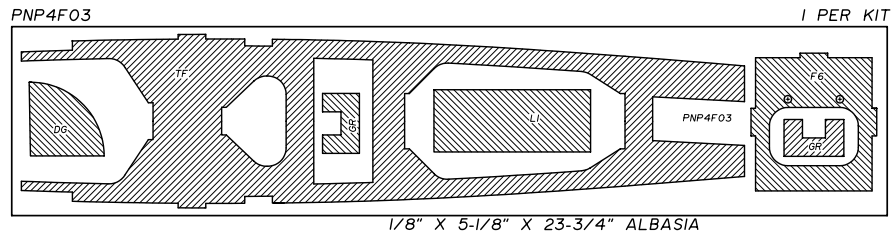
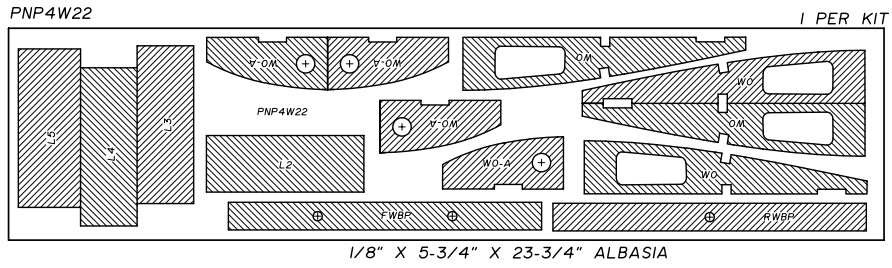

BUILD THE TAIL SURFACES

Build the Fin & Rudder

1. Place the fin portion of the fuse plan over your **flat** building board. Cover the plan with Great Planes Plan Protector.

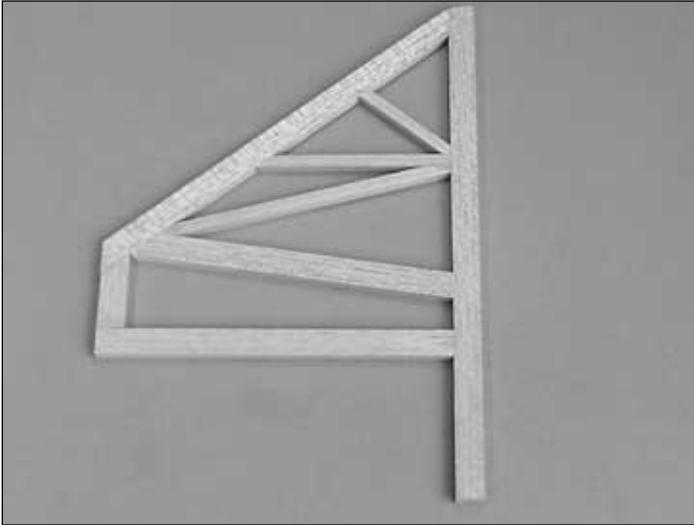

2. Build the **fin** over the plan from two 1/4" x 1/2" x 30" balsa sticks and one 1/4" x 1/4" x 30" balsa stick. Save the leftover balsa sticks for the rudder.

EXPERT TIP
EXBEVL LIB

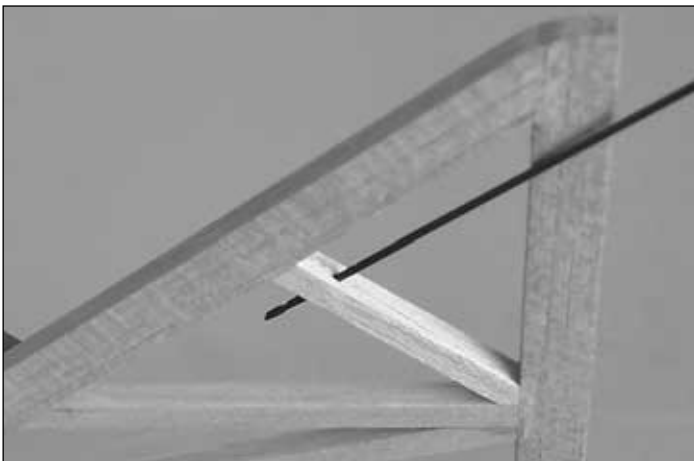

During the covering process heated air, sealed inside the structure, expands and does not allow the covering to fully tighten. Drill 1/16" holes through the 1/4" x 1/4" balsa sticks. Later, holes will be drilled through the trailing edge of the stab and fin and through the leading edge of the rudder and elevators so this expanded air can escape, thus allowing the covering to fully shrink.

3. Remove the fin from the plan and sand both sides flat with a bar sander and 80-grit sandpaper.

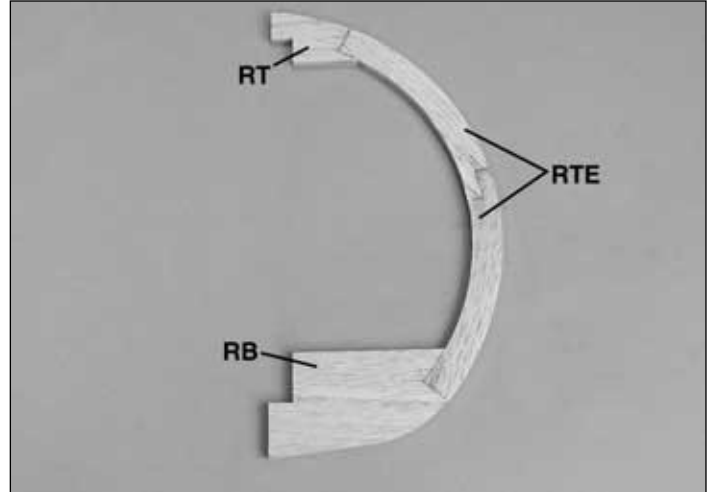

4. Cover the **rudder** portion of the plan with Plan Protector. Building over the plan, glue together the die-cut 1/8" balsa rudder parts **RB**, **RTE**, **RT**. Note that there are **two** of each part, making a total thickness of 1/4".

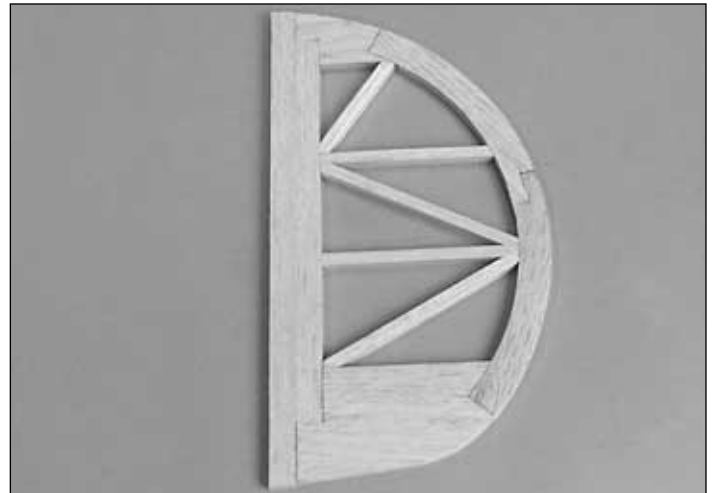

5. Finish building the rudder using the remainder of the balsa sticks you used for the fin and an additional 1/4" x 1/4" x 30" balsa stick. Remove the rudder from the plan and sand both sides flat.

Build the Stab & Elevators

1. Place the **stab** portion of the wing plan over your **flat** building board and cover it with Great Planes Plan Protector.

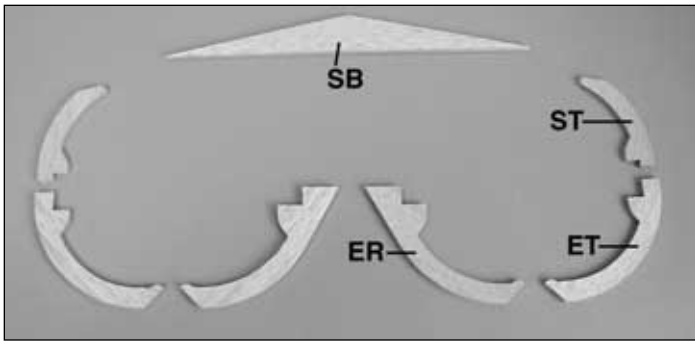

❑ 2. The same as when building the rudder, glue together the die-cut 1/8" balsa stab and elevator parts **SB**, **ST**, **ET** and **ER**.

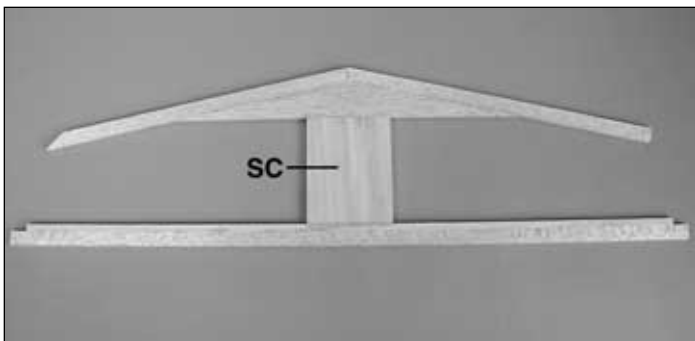

❑ 3. Start building the **stab** over the plan, first by pinning SB into position, then by gluing the 1/4" x 3" x 3-15/16" **stab center (SC)** to it. Trim the 1/4" x 1/4" x 24" basswood stick to the length on the plan, then glue it into position, followed by two 1/4" x 1/2" x 30" balsa sticks for the stab LE and TE.

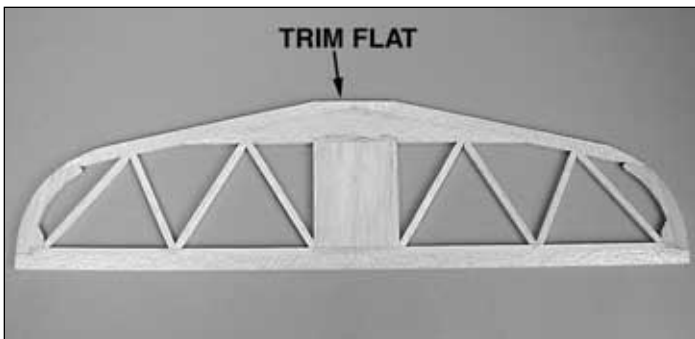

❑ 4. Finish framing the stab by gluing the stab tips (ST) to the assembly followed by the 1/4" cross-braces cut from two more 1/4" x 1/4" x 30" balsa sticks.

❑ 5. Remove the stab from the plan. Trim the center of the LE as shown on the plan, then sand both sides of the stab flat.

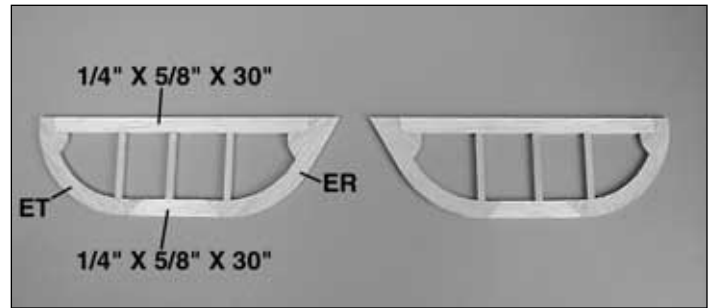

❑ 6. Build both elevators over the plan using the die-cut parts shown, the 1/4" x 5/8" x 30" balsa stick and leftover 1/4" x 1/4" balsa sticks. Do not add the elevator joiner wire until instructed to do so. Remove the elevators from the plan and sand both sides flat.

Hinge the Tail Surfaces

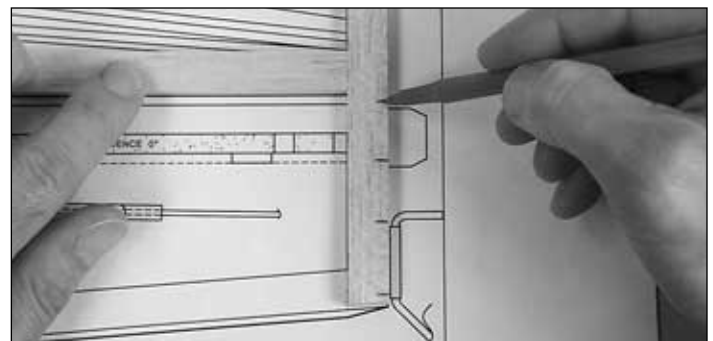

❑ 1. Mark the hinge locations on the fin and rudder and stab and elevators.

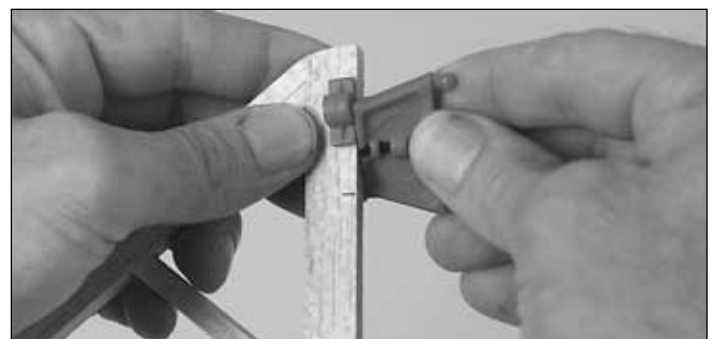

❑ 2. Use a Great Planes Precision Center Marking Tool (GPMR4005) to make a centerline on the TE of the fin and stab and on the LE of the elevators and rudder.

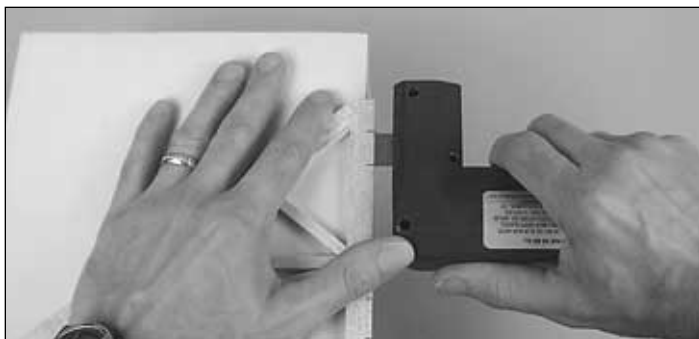

❑ 3. If you have a Great Planes Slot Machine hinge slotting tool, cut the hinge slots in all of the tail surfaces. If you do not have a Slot Machine, cut the hinge slots as described below:

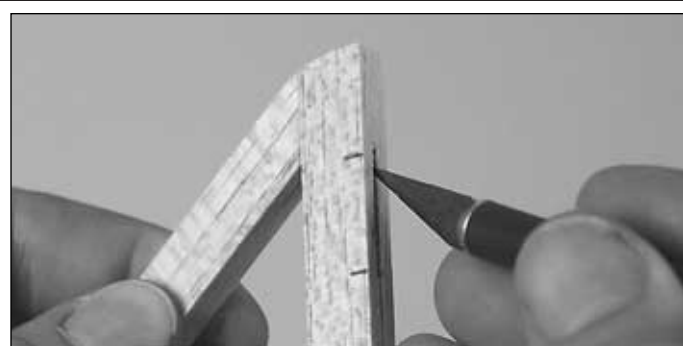

❑ A. Use a hobby knife with a #11 blade to cut a shallow slit on the centerline at the hinge slot location. This initial cut is to establish the location of the hinge slot, so don't cut deep and stay on the line.

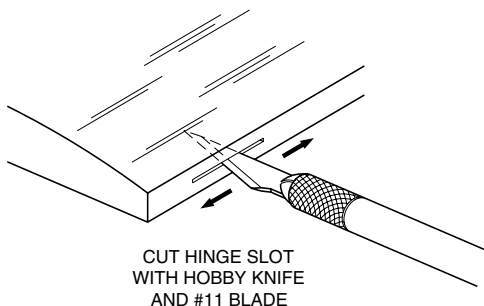

❑ B. Make more cuts **straight** into the wood, going deeper each time. As shown by the arrows in the sketch, **carefully** swing the knife in both directions and push the blade back and forth to make a slot that will accommodate the hinge.

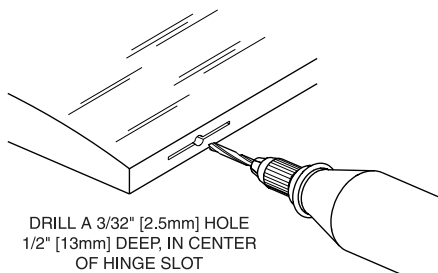

❑ C. Drill a 3/32" hole, 1/2" deep in the center of the hinge slots. Use a rotary tool with a drill bit or a carbide cutter for the best results. After drilling the holes, clean out the slots with a knife blade.

❑ 4. Cut nine 3/4" x 1" **hinges** as shown on the plan from the CA hinge strip. Snip the corners off so they go in easier.

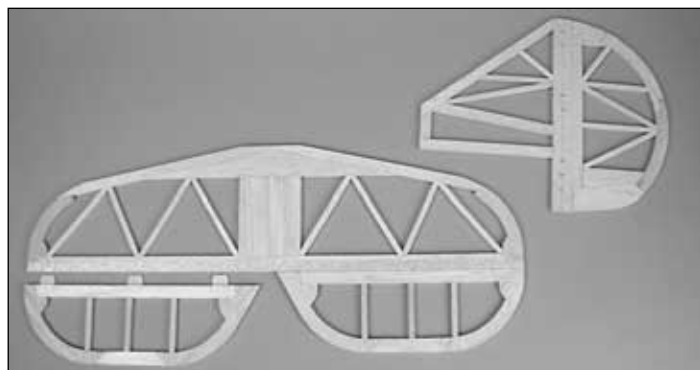

❑ 5. **Temporarily** join the elevators to the stab and the rudder to the fin with the hinges. Lengthen or deepen any hinge slots as necessary so the rudder aligns with the fin and the elevators align with the stab. (*One elevator is shown off the stab just so you can see the hinges*).



❑ 6. Position the **elevator joiner wire** on both elevators as shown. Mark the location of the ends of the wire on the elevators.

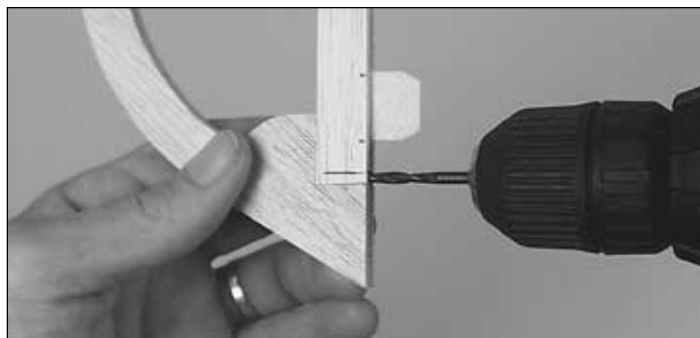

❑ 7. Drill a 9/64" (or 1/8") hole 3/4" deep through the leading edge of both elevators for the joiner wire.

BUILD THE WING

Build the Center-Section

1. Cut four 8-3/4" long sheets from a 3/32" x 4" x 36" balsa sheet. Follow the **Expert Tip** below to glue the sheets together, making a 8-3/4" x 16" skin for the bottom center-section sheeting.



How to glue together sheeting

- A. Use a straightedge to true the joining edges of each sheet.
- B. Tightly tape the sheets together with masking tape.



- C. Flip the sheets over and apply aliphatic resin such as Great Planes Pro Wood Glue between the seams.



- D. Place the sheets on your workbench covered with Plan Protector to keep the glue from sticking to the bench. Use a squeegee such as an expired credit card or something similar to wipe off excess glue. Use weights to hold the sheets down until the glue dries.

2. Make a second 8-3/4" x 16" skin the same way for the top center-section sheeting. After the glue has dried, remove the masking tape and sand both skins flat and smooth.

3. Trim one of the center-section skins to a length of 13-3/4". Place the skin over the center-section of the plan. Align the

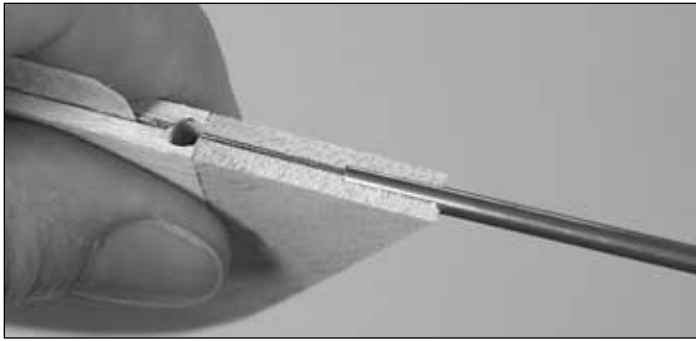

8. Cut a 1/8" groove in the leading edge of both elevators to accommodate the wire. **Hint:** Use a Great Planes *Groove Tube™* Cutting Tool (GPMR8140) or a 1/8" brass tube sharpened on one end to cut the grooves.

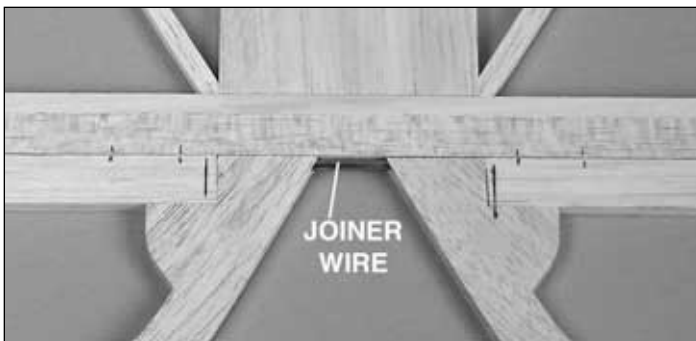

9. Insert the joiner wire into both elevators. Make sure the elevators lie flat on your workbench. If both elevators do not lie flat, "tweak" the joiner wire as necessary.

10. Use a bar sander with 80-grit sandpaper to round the outer edges of all the tail surfaces. Use a razor plane or a bar sander to bevel the leading edge of the elevators and rudder to allow for control throw movement. **Hint:** Do not make the bevel too sharp. Refer to the cross-section on the plan to get the correct angle of the bevel.

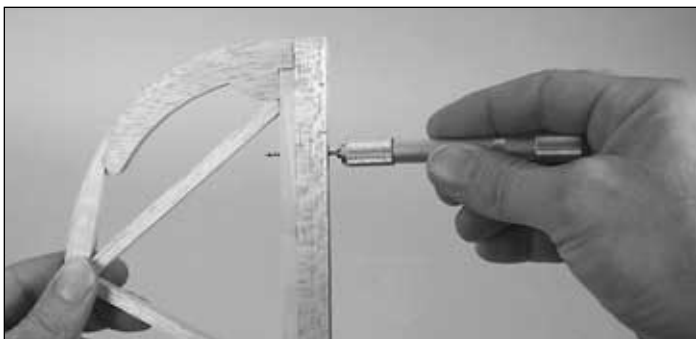

11. Drill 1/16" or 3/32" holes through both tips of the stab, and the tip of the fin, rudder and elevators, to vent air that would otherwise be trapped and expand while shrinking the covering.

front edge of the skin where indicated by the arrows on the plan. Pin the skin into position.

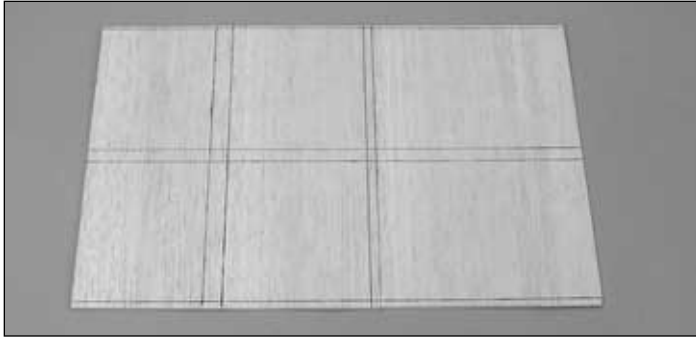

4. Align a straightedge with the tick marks on the plan and mark the locations of the ribs and spars directly on the skin.

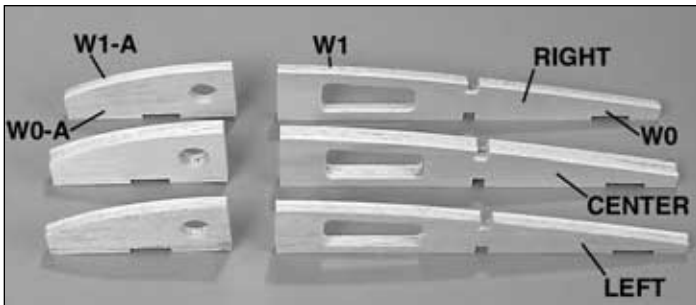

5. Glue together the die-cut 1/8" plywood and balsa **sub ribs W1-A and W0-A and W1 and W0** as shown on the plan to make the ribs for the center-section. Be certain you make a **right and left** set of ribs that go on the ends of the center-section. Note that the center ribs consist of a balsa rib "sandwiched" between two plywood ribs.

6. Cut a 8-1/2" long **center main spar** from each of two 3/8" x 1/2" x 36" balsa sticks (the remainder of the sticks will be used for the bottom main spars in the outer wing panels). Be certain you accurately cut the spars to a length of 8-1/2" and that the ends are square.

7. Glue a center-section main spar to the center-section sheeting where indicated by the lines you marked.

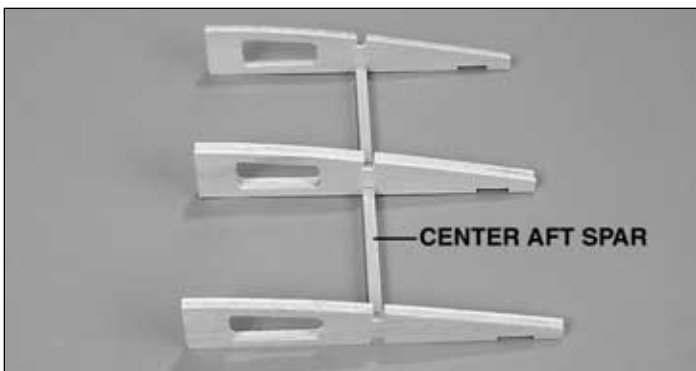

8. Cut two 8-1/2"-long **center aft spars** from each of the two 1/4" x 1/4" x 36" balsa sticks (the remainder of the sticks will be used for the bottom aft spars in the outer wing panels). Fit the three aft center-section ribs to the bottom center aft spar.

Refer to this photo for the following two steps.

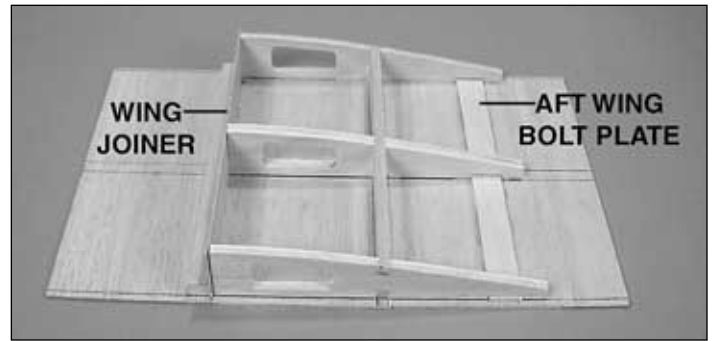

9. Add the top center aft spar and the die-cut 1/8" plywood **aft wing bolt plate** to the ribs. Position but do not glue the assembly on the center-section sheeting, accurately aligning the ribs with the marks.

10. Temporarily place one of the die-cut 1/16" plywood **wing joiners** behind the center main spar to act as a spacer. Push the ribs forward against the joiner. Then, using a small builder's square to make certain the ribs are vertical, glue them into position. **Do not** inadvertently glue the joiner to the bottom spar or ribs.



11. Join the three forward center ribs and the die-cut 1/8" plywood **forward wing bolt plate** to the assembly. Glue them into position using a 1/16" ply wing joiner as a spacer. Be certain the outer forward ribs are in alignment with the outer aft ribs and be certain they are vertical.



12. Glue the 1/2" x 2" x 9-1/16" balsa **trailing edge block** into position.

13. Tack-glue leftover 1/4" x 1/2" balsa sticks across the outer ribs to stabilize the center-section for sanding in the next step. (You can see the sticks in the following photo.)

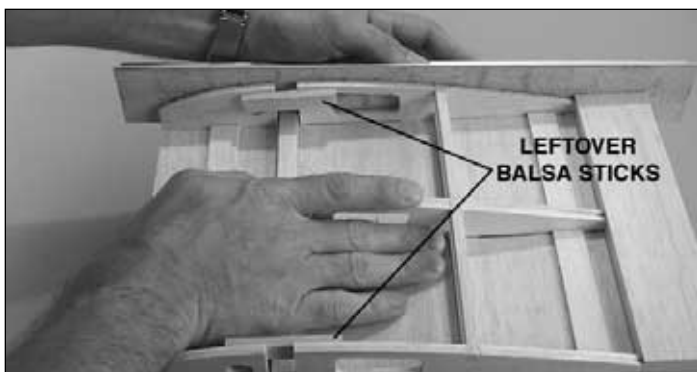

14. Remove the center-section from the plan. Use a bar sander with 80-grit sandpaper to sand the bottom sheeting and the trailing edge block even with the outer ribs.

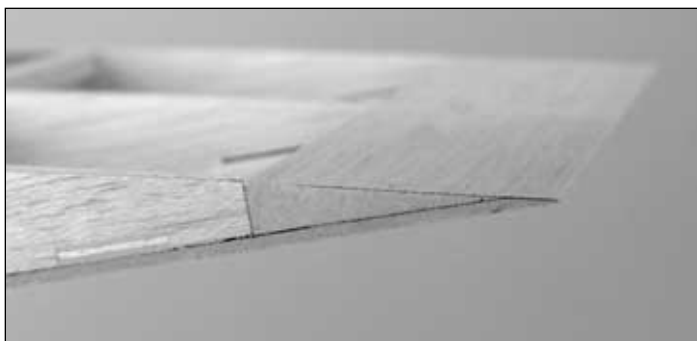

15. Sand the top of the trailing edge block even with the top of the center-section.

16. Remove the 1/4" x 1/2" balsa sticks you tack-glued across the outer ribs. Reposition the center-section over the plan.

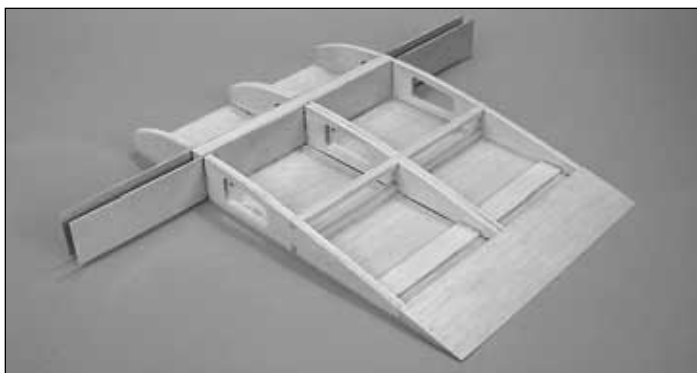

17. Test fit all four die-cut 1/16" plywood **wing joiners** and the top center main spar. Note that the "WJ" stamped onto each wing joiner must be toward the top.

18. Remove the wing joiners and the top center main spar. Apply 30-minute epoxy to all joining surfaces and permanently glue the pieces into position. Wipe away excess epoxy before it hardens. Be certain the bottom of each wing joiner is fully contacting the bottom center-section sheeting.

Refer to this photo for the following three steps.

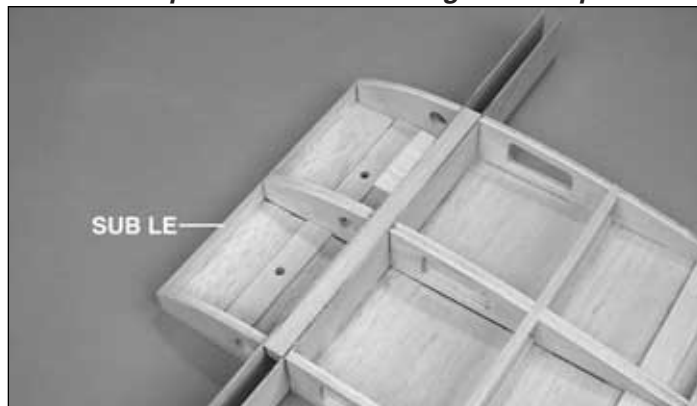

19. Glue a leftover 3/32" balsa sheet inside the bottom center-section sheeting where shown on the plan to reinforce the opening that will be cut later for the aileron servo wires.

20. Cut the **center-section sub LE (leading edge)** from the 1/16" x 3/4" x 36" balsa stick. Glue the sub LE into position.

21. Poke a T-pin through the bottom center-section sheeting in the center of the holes in the forward wing bolt plate. This will note where to drill holes later for the wing bolts. **Hint:** For the most accuracy, use a 1/4" brass tube sharpened on one end to cut a circular hole in the sheeting.

22. Make the **aft support blocks** by cutting the 1/2" x 3/4" x 9-1/16" balsa block into two 3-13/16" lengths. Make the **forward support blocks** by cutting the 3/4" x 1-1/4" x 9-1/16" balsa block into two 3-13/16" lengths.



23. Glue both aft support blocks to the aft wing bolt plates and glue both forward support blocks to the forward wing bolt plates. Shape the top of the blocks to match the top of the center-section.

Finish the Center-Section

SAND TO MATCH
AIRFOIL

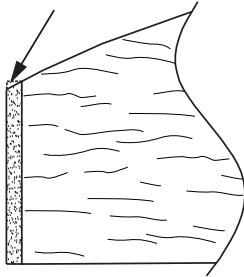

❑ 1. Use a bar sander with 80-grit sandpaper to sand the top of the center-section so all the ribs, spars, joiners and sub LE are even. Relocate or remove any T-pins that will be concealed under the sheeting when it's glued into position.

❑ 2. Use thick CA or Great Planes Pro Wood Glue to glue the top center-section sheeting into position.

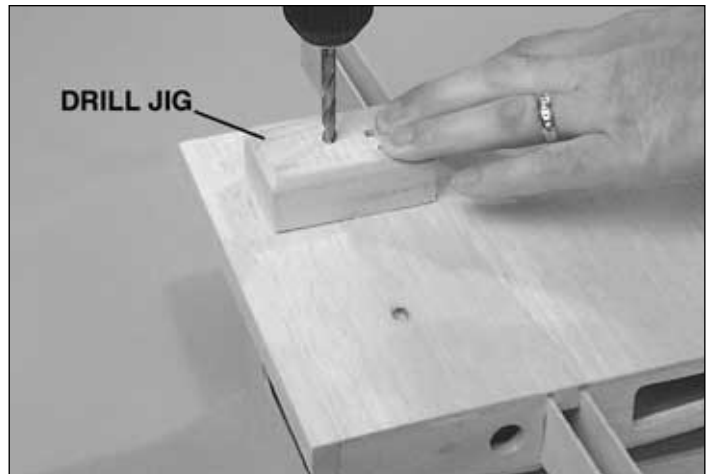

How to drill perpendicular holes.

To be certain the holes are perpendicular to the bottom surface of the wing, make a **drill jig** by using a drill press to drill a 1/4" hole through a hardwood block. Set up the drill press to drill the hole vertically. Use the drill jig to guide the drill, thus ensuring that the holes are perpendicular.

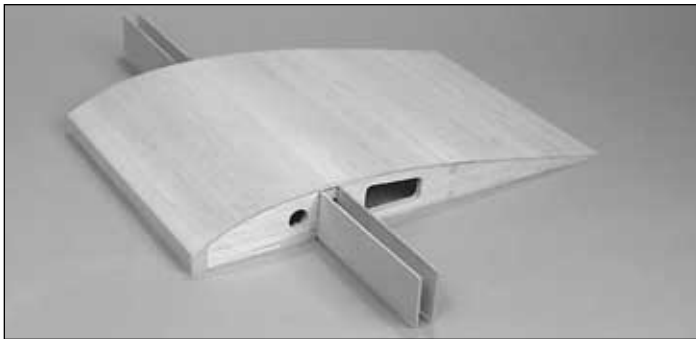

❑ 3. Remove the center-section from the building board. Trim the edges of the top sheeting even with the ribs and the sub LE. Cut the **center-section LE** from the 3/8" x 7/8" x 36" balsa stick and glue it into position. Trim the LE even with the ends of the center-section and the top sheeting, but do not round the LE until instructed to do so.

❑ 4. Taking measurements from the plan, use a hobby knife with a #11 blade to cut a hole in the bottom sheeting over the die-cut hole in the middle of the aft wing bolt plate.

❑ 5. Refer to the Expert Tip that follows. Using the holes in the wing bolt plates as a guide, drill three 1/4" holes through the center-section of the wing.



❑ 6. Temporarily fit the 1/4-20 nylon wing bolts into the holes in the center-section. Use a ballpoint pen to draw a circle on the sheeting around the heads of the bolts. Remove the wing bolts, then use a hobby knife to cut the sheeting to accommodate the heads so they will be inset below the sheeting. **Hint:** Use a dowel with sandpaper on the end to sand the bottoms of the holes smooth.

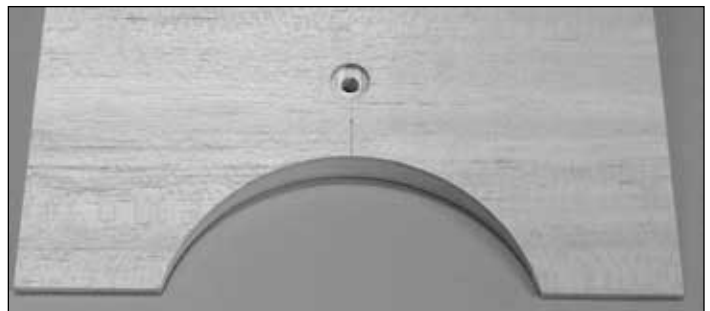

❑ 7. Use a small razor saw or a hobby knife to cut the circular opening in the trailing edge of the center-section. Sand the edges of the opening smooth.

Build the Outer Panels

Build the **right** wing panel first, so you can follow the photos the first time through.

1. Place the **right** wing panel plan over your **flat** building board and cover it with Plan Protector.

2. Gather the two 3/8" x 1/2" x 27-1/2" balsa sticks leftover from the center-section and the two 3/8" x 1/2" x 30" balsa sticks supplied in the kit. These four sticks will be the **main spars** for the outer wing panels.

TWO WARPED SPARS INSTALLED
THIS WAY WILL RESULT IN A
STRAIGHT WING



TWO WARPED SPARS INSTALLED
THIS WAY WILL RESULT IN A
WARPED WING



3. Pair the main spars so the warps, if any are present, will cancel each other out as shown in the sketch. Use a ballpoint pen to mark the spars so they will be installed in the wing as intended to cancel the warps. Set the spars aside.

Refer to this photo for the following four steps.

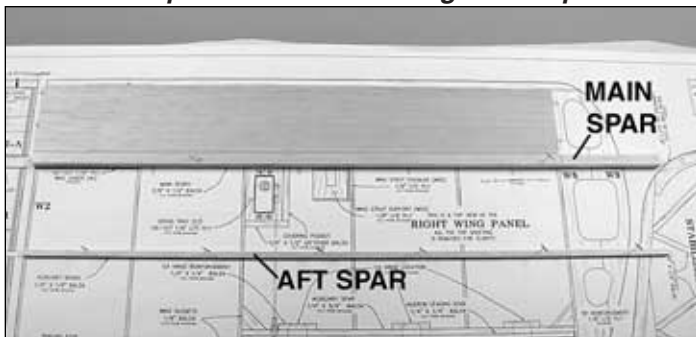

4. Make a **bottom LE sheet** by cutting a 3/32" x 4" x 30" balsa sheet to a length of 22-3/4". Use a long straightedge and a hobby knife with a #11 blade to true one of the *long* edges of the sheet. This will be the aft edge.

5. Pin the bottom LE sheet to the plan, aligning the aft edge and the tip where indicated by the arrows on the plan.

6. Glue one of the main spars to the bottom LE sheet pinned to the plan (being certain it is oriented as you intended to cancel out a warp). The aft edge of the spar aligns with the aft edge of the sheet and the root end of the spar aligns with the root end of the sheet. The tips of the spar will be trimmed to the correct length later.

7. Pin one of the 1/4" x 1/4" x 27-1/2" **aft spars** (leftover from the center-section) over its location on the plan. The same as the bottom main spar, the root end of the aft spar aligns with the root of the bottom LE sheet and the tip of the aft spar will be trimmed later.

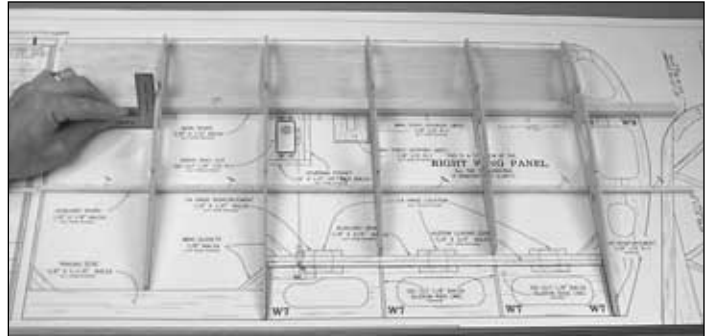

8. Glue the die-cut 1/8" balsa **ribs W3** through **W6** to the spars and bottom LE sheeting. As you proceed, use a small builder's square to hold each rib vertical and be certain the ribs are fully contacting the building board. If necessary, use T-pins to hold the ribs down to the building board.

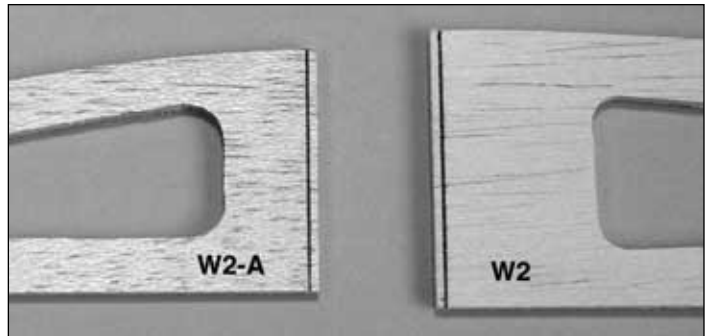

9. Use a straightedge and a ballpoint pen to draw a line on the die-cut 1/8" balsa rib **W2-A** 1/16" from the **aft** edge. Draw a line on the die-cut 1/8" balsa rib **W2** 1/16" from the **front** edge.

10. Use a hobby knife to cut about halfway through both ribs on the line.

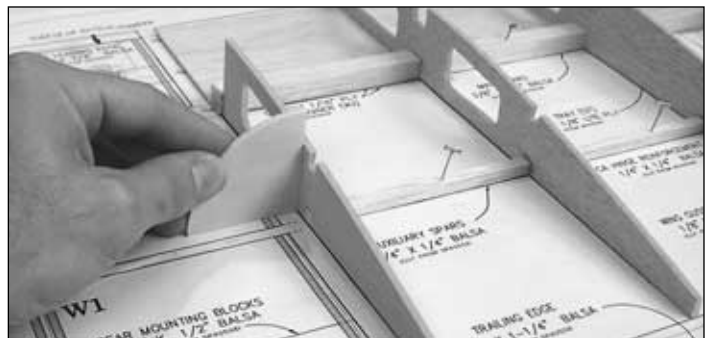

11. Use the die-cut 1/8" plywood **dihedral gauge** to set the die-cut 1/8" balsa rib **W2** at the correct angle, then glue it into position.

12. Glue the 3/8" x 1/2" x 30" balsa **top main spar** and the 1/4" x 1/4" x 30" balsa **top aft spar** to the assembly. Use the dihedral gauge to hold **W2** at the correct angle when gluing it to the spars.

13. Make the **tip reinforcement** for rib W6 where shown on the plan from leftover 1/8" plywood, then glue it into position.

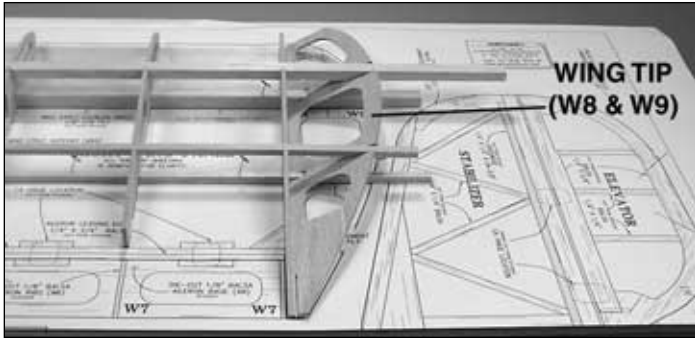

14. Glue together both die-cut 3/32" balsa **wing tip parts W8 and W9** to make a **wing tip**. Sand a bevel to the bottom edge of the wing tip where it joins the wing. Test fit the wing tip to the wing, make adjustments to the wing tip where necessary, and then glue it into position.

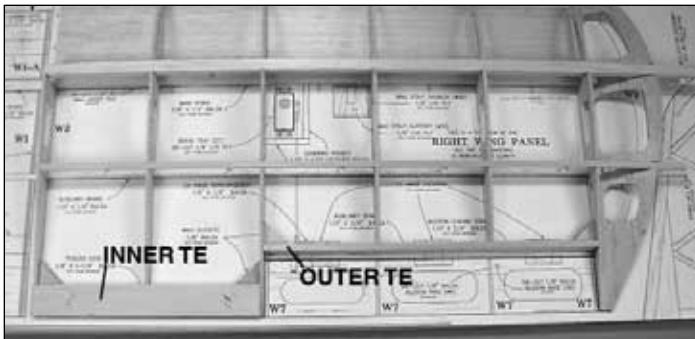

15. Cut the **outer trailing edge** from a 1/4" x 3/4" x 30" balsa stick and glue it into position to ribs W4 through W6. Glue a die-cut 1/8" balsa **gusset** to the outer TE and ribs W4 and W6.

16. Cut the **inner trailing edge** from the 3/8" x 1-1/4" x 24" balsa stick and glue it into position to ribs W2, W3 and W4 (if you're on the left wing panel, cut the inner TE from the remainder of the piece you used for the right panel). Glue the two gussets where shown on the plan.

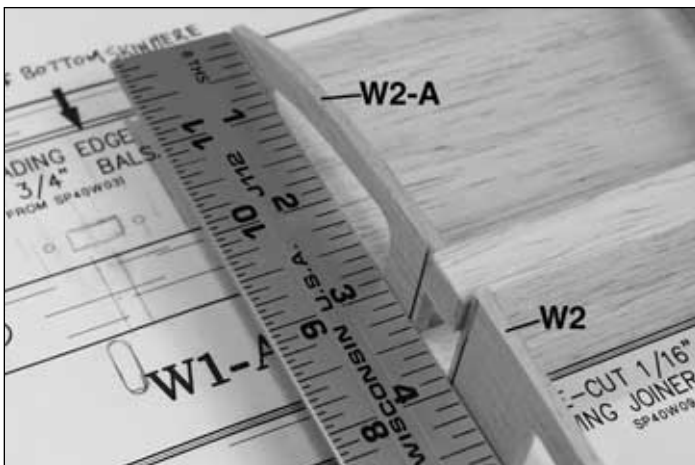

17. Glue rib W2-A into position using the dihedral gauge to set it at the correct angle and a straightedge to align it with rib W2.

18. Use the remainder of the 1/16" x 3/4" balsa stick you used for the center-section sub leading edge as the sub leading edge for the outer panel (if you're building the left wing panel, use a 1/16" x 3/4" x 30" balsa stick for the sub LE). Trim the end of the sub LE to match the angle of the wing tip, then glue the sub LE into position.

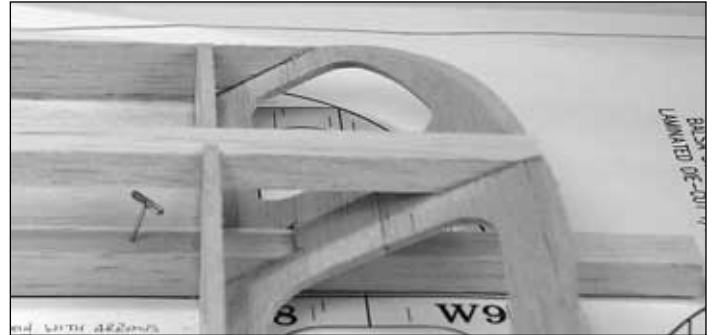

19. Cut the top main spar and the top aft spar at the wing tip. Use a bar sander with 80-grit sandpaper to sand the sub LE and the wing tip even with the ribs.

20. Cut two 1-3/8" **shear webs** from the 3/32" x 4" x 30" balsa sheet and glue them to the front of the main spars between ribs 3 & 4 and 4 & 5 as shown on the plan. Save the rest of the sheeting for the top of the wing.

21. Remove the wing from the building board. The same as you did for the trailing edge block on the center-section, shape the inner trailing edge and the outer trailing edge of the outer panel to match the shape of the top of the wing. Trim the bottom spars even with the wing tip. Sand the bottom LE sheeting even with the sub LE.



22. Use a bar sander with 80-grit sandpaper to sand the root end of the wing panel true and even. Use a razor saw to cut along the lines you marked on ribs W2-A and W2, making a slot to accommodate the 1/16" ply joiners.

23. Take the right wing panel plan off your building board. Place the **left** wing panel plan over your building board, then return to step 4 and follow the instructions to build the **left** wing panel. Be certain to place the **left** wing panel plan over your building board, so you don't build another right wing.

Join the Wing Panels

1. Test fit both wing panels to the center-section. Lay the wing on your flat workbench and place weights on the center-section to hold it down. Raise both wing tips 1/4" by placing a leftover 1/4" balsa stick under rib W6 on both ends of the wing. Make adjustments where necessary for a good fit between both outer panels and the center-section.

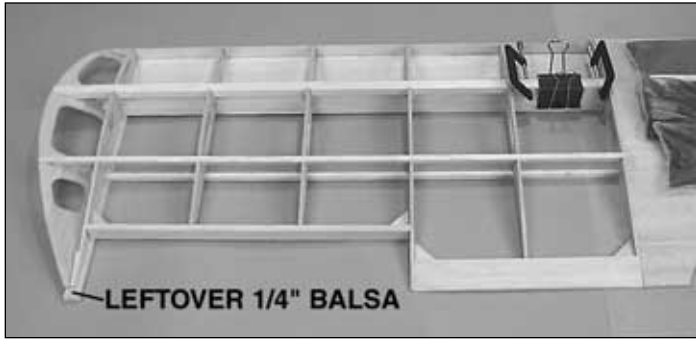

2. Once you have achieved a good fit between the joining wing sections, mix up a batch of 30-minute (or 45-minute) epoxy and coat all joining surfaces. Join the outer panels to the center-section the same as you did in the previous step (with weights on the center-section and both tips propped-up 1/4"). Use clamps to hold the pieces together. Use T-pins to hold ribs W2 and W2-A to W1 and W1-A. Wipe away excess epoxy before it hardens and do not disturb the wing. If there is a gap between the top outer panel spars where they join the top center-section spars, add microballoons or milled fiberglass to the leftover epoxy and use it to fill the gap.

3. After the epoxy has fully hardened, remove the wing from your workbench and take off the clamps. Use a hobby knife to trim any excess blobs of epoxy and sand the top and bottom of the wing.

4. Guide a piece of string through both wing panels from rib W4 into the center-section. Later, the servo wires will be attached to the string so they can be pulled through a hole that will be cut in the bottom of the center-section for connecting to the receiver.

Refer to this photo for the following four steps.



5. Pin the right wing panel to the building board. Sheet the top of the right wing panel using the remainder of the

3/32" x 4" x 30" balsa sheet you cut the shear webs from. Note that the sheet must be shifted slightly forward of the top main spar, so it will reach the sub LE (the gap between the sheet and the top of the ribs will be filled after the sheeting is done). If necessary, soften the outside of the sheet by dampening it with window cleaner or water so it will bend around the ribs easier.

6. Remove the right wing panel from the building board. Pin the left wing panel to the building board and sheet it the same way.

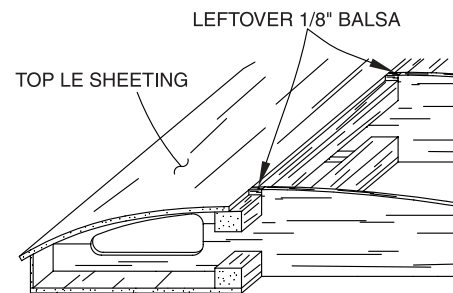

7. Fill the gap between the tops of the ribs and the LE sheeting with leftover 1/8" balsa. Sand the sheeting even with the sub LE and the wing tip. Sand the spars even with the wing tip.

8. Glue the 3/8" x 7/8" balsa leading edges to the wing. Trim the LE's even with the sheeting and the wing tip, then final-shape them as shown in the cross-sections on the plan.

Build the Ailerons

The ailerons are built on the plan with the wing in position, thus ensuring the best fit.

Refer to this photo for the following four steps.



1. Place the right wing panel plan over your building board and cover the aileron plan with Great Planes Plan Protector. Align the right wing panel with the plan and pin it into position.

2. Mark the location of the aileron ribs on the top of the die-cut 1/8" balsa aileron base.

3. Cut the aileron leading edge to the length shown on the plan from the remainder of the 1/4" x 3/4" x 30" balsa stick you used for the outer TE of the wing. Use T-pins or clamps to hold the aileron LE to the outer TE.

4. Use thin or medium CA to glue the aileron base to the aileron LE. Glue four die-cut 1/8" balsa **aileron ribs W7** to the aileron base and the aileron LE.



5. Remove the clamps (if you've used any) and T-pins that will get in the way of sanding, but leave the aileron and wing pinned down. Sand the top of the aileron LE and the aileron ribs to match the wing.

6. Remove the aileron and the wing from the plan. Cut six 1-1/2"-long **hinge blocks** from leftover 1/4" x 1/4" balsa sticks and glue them to the outer TE and the aileron LE where shown on the plan. Make certain the hinge blocks are centered vertically.

7. Mark a centerline on the LE of the aileron and on the outer TE of the wing. Cut the hinge slots and temporarily join the aileron to the wing with the hinges. Make adjustments to the hinge slots where necessary, so the hinge slots align and the aileron aligns with the wing.

8. Trim the hinge block, then glue the die-cut 1/8" plywood **control horn plate** to the aileron base and the aileron LE (*you can see the control horn plate in the following photo*).



9. Use a razor plane or a bar sander with 80-grit sandpaper to sand a bevel on the leading edge of the aileron.

You may go back and build the left aileron now, or proceed and hook up the servo first.

Hook Up the Ailerons

1. Test fit the aileron servo in the die-cut 1/8" plywood **aileron servo tray**. If necessary, make adjustments so the servo will fit.



2. Glue two leftover 1/4" x 1/2" balsa sticks to the **outer** and **aft** edge of the servo tray. (The photo shows the right servo tray. If this is your second time through, be certain you are building the **left** servo tray.)

3. Turn the aileron servo tray over. Glue strips of leftover 1/8" ply across the **top** to give the servo mounting screws something more to "bite" into.



4. Glue the aileron servo tray into position as shown. Glue an additional strip of leftover 1/4" x 1/4" balsa to the side of rib W4. Drill 1/16" holes for the servo screws, then mount the aileron servo to the tray with the screws that came with it.

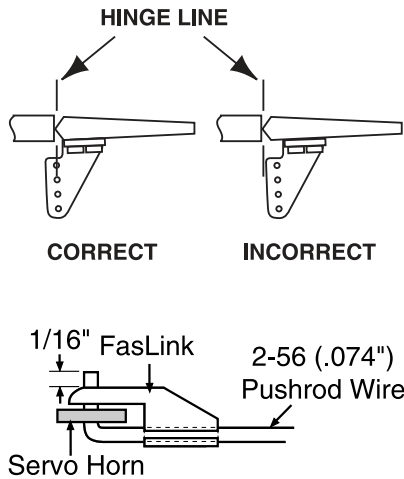
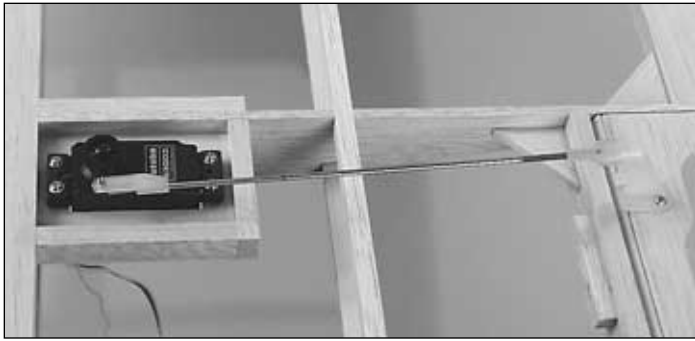

5. Use a Hobbico Servo Horn Drill (HCAR0698) (or a #48 or 5/64" drill bit) or a hobby knife to enlarge the hole in the aileron servo arm for the aileron pushrod. Connect the aileron servo to the aileron with the hardware shown on the plan and in the photo. When mounting the aileron control horn to the aileron, use the holes in the horn as a guide to drill 1/16" holes for the #2 x 3/8" screws. Add a drop of thin CA to each hole and allow it to harden before mounting the horn.

6. If you haven't already done so, build the other aileron, then mount the servo and connect it to the aileron the same way.

Just a few last-second things to do, then it's on to the fuselage.

Finish the Wing

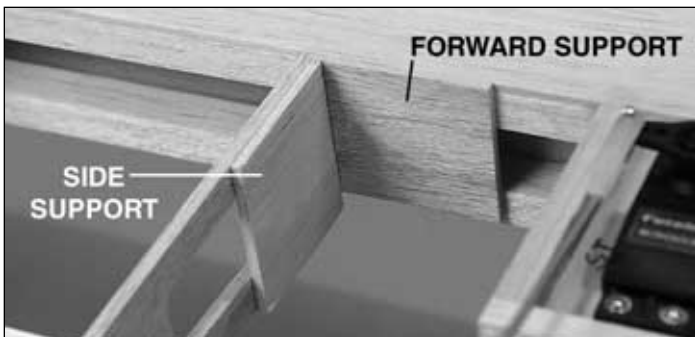

1. Glue the die-cut 3/32" balsa **forward support** to the spars with the bottom edge even with the bottom of the wing. Glue the die-cut 1/8" plywood **side support** to rib W5.

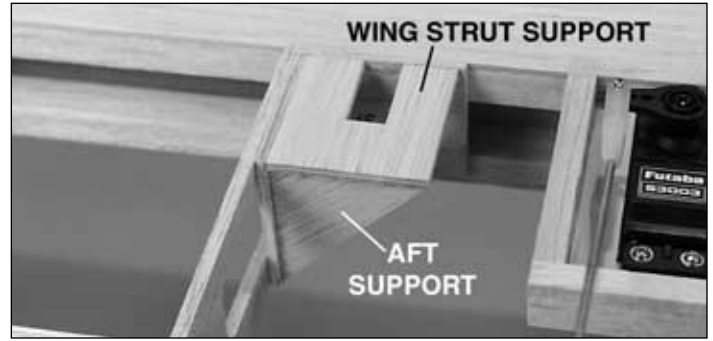

2. Glue the die-cut 1/8" plywood **wing strut support** to the forward support and the side support, then glue the die-cut 3/32" balsa **aft support** into position as shown.

3. Cut a hole in the bottom wing sheeting that will not interfere with the main wing struts, then use the string you built into the wing to route the servo wires through the hole and out to the servos. Connect the extension cords to the servo wires. Secure the connection with vinyl tape or clips intended for that purpose.

BUILD THE FUSELAGE

Build the Fuselage Sides & Top

1. Position the fuselage plan so the **fuselage side view** is over your **flat** building board. Cover the plan with Great Planes Plan Protector.

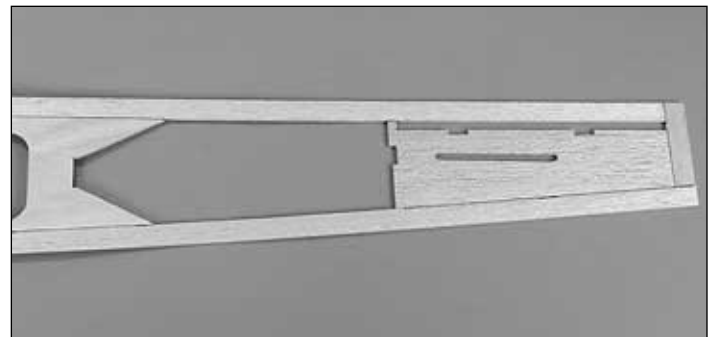
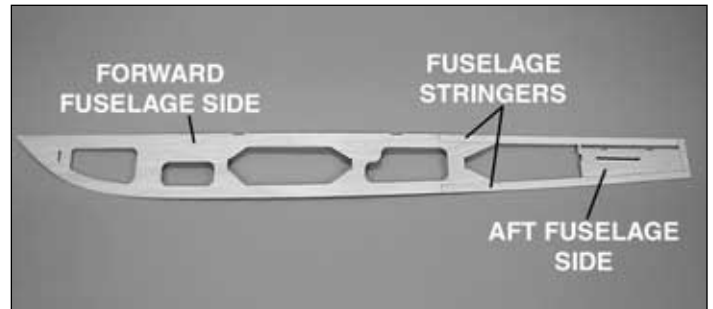

2. Pin one of the die-cut 1/8" plywood **forward fuselage sides** and one of the die-cut 1/8" balsa **aft fuselage sides** over their locations on the plan. Cut the **fuselage stringers** from a 1/8" x 1/2" x 36" balsa stick and glue them into position, joining the forward and aft fuselage sides.

❑ 3. Remove the fuselage side from the plan and sand both sides flat.

❑ 4. Build another fuselage side the same way.

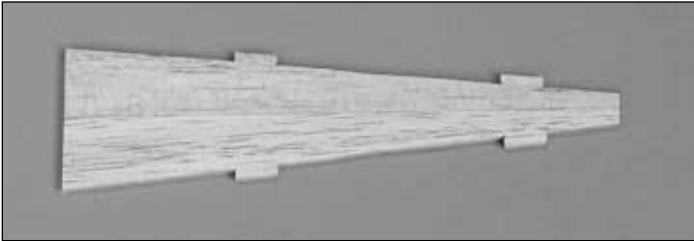

❑ 5. Glue both die-cut 1/8" balsa **stab bases** together.

❑ 6. Test fit the servos in the die-cut 1/8" plywood **forward fuse top** to be certain they fit. If necessary, enlarge the opening to accommodate the servos.

❑ 7. Position the fuse plan so the **bottom view** of the fuselage is over your building board and cover it with Great Planes Plan Protector. Pin the forward fuse top over its location on the plan. Be certain the fuse top aligns with the plan (align the cut-out in the front of the fuse top for the engine mount with the plan).

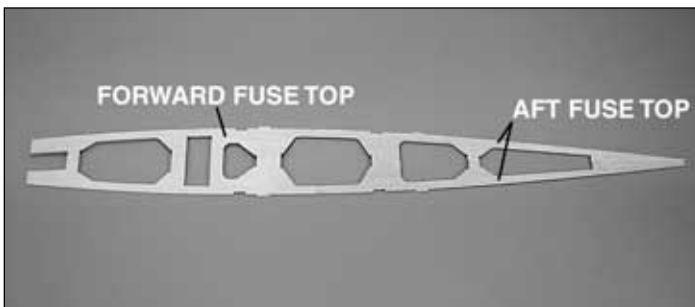

❑ 8. Working over the plan, glue both halves of the die-cut 1/8" balsa **aft fuse top** to each other and to the forward fuse top. Hold the aft fuse top to the building board with T-pins.

Frame the Bottom of the Fuselage



❑ 1. Glue the die-cut 1/8" plywood **formers F1, F2, F3, F5, F6** and the die-cut 1/8" balsa **former F7** into position on the fuselage top (be certain that the hole in F2 is on the same side of the fuselage as the carburetor arm on your engine). As you proceed, use a builder's square to be certain each former is perpendicular to the building board. **Note:** While

building the fuselage, do not build up large fillets of glue, as they may interfere with some of the other parts that will be added to the assembly later. When the fuselage is nearly completed, we will remind you to reinforce areas that you may have missed or areas that require additional strength.

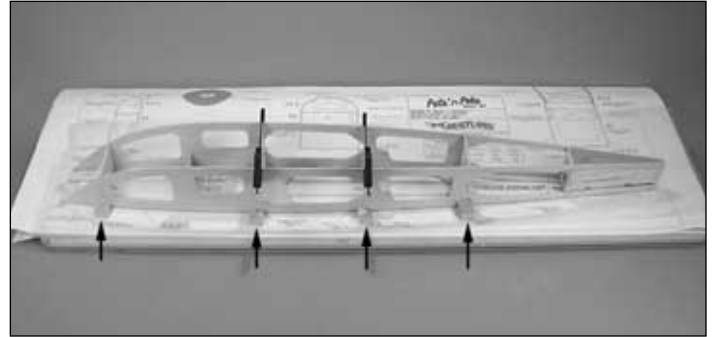

❑ 2. Without using any glue, join both fuselage sides to the fuse top and the formers. Hold the fuselage sides in position with T-pins and clamps. **Hint:** Cut several balsa blocks from a 3/4" x 3/4" balsa stick (or similar size, not supplied) and pin the blocks to the building board tightly, holding the fuse sides to the fuse top.

❑ 3. Make adjustments to any of the notches or tabs where necessary for a good fit. Be certain the top edge of both fuse sides is fully contacting the plan. Use medium or thin CA to securely glue the fuse sides to the fuse top and to all the formers.

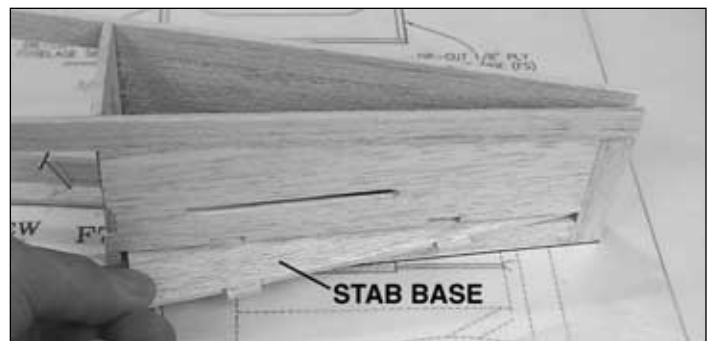

❑ 4. Insert the stab base into the aft end of the fuse through the slot for the stab in one of the fuse sides. Raise the stab base up into position, making certain it is fully seated into the notches, then glue it into place.

❑ 5. Refer to the photo in the following step, then glue the die-cut 1/8" plywood **engine mount doubler** to the bottom of the forward fuse top. Be certain the cutout in the doubler matches the cutout in the forward fuse top.

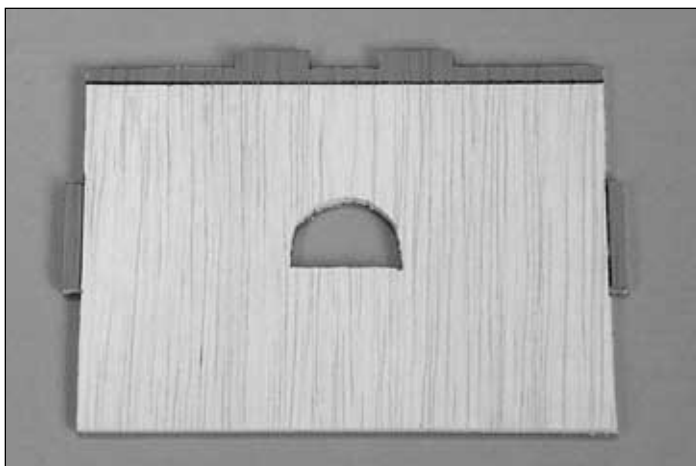
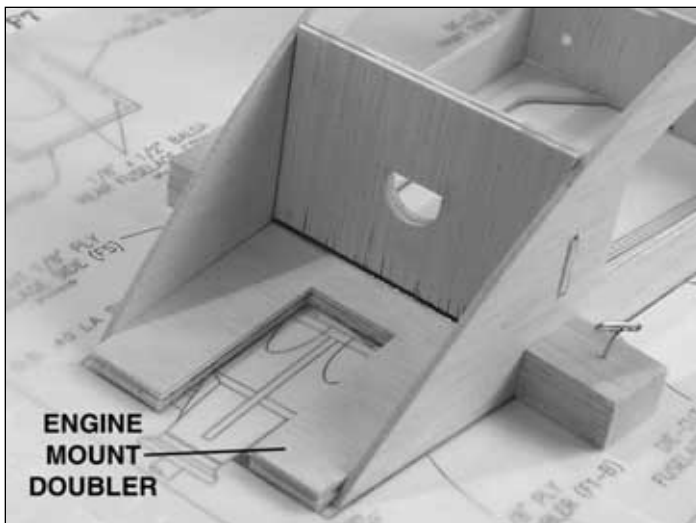

6. Trim 1/8" from the top of the remaining die-cut 1/8" plywood former F1, and trim the tab from both sides as indicated by the shaded area. Glue F1 into position as shown.

Refer to this photo for the following two steps.

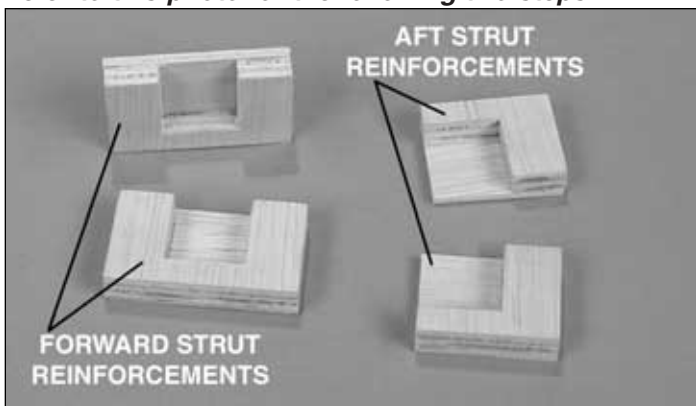

7. Make two 3/8"-thick **forward strut reinforcements** by gluing together two die-cut 1/8" plywood **forward strut reinforcements (FR)** and one die-cut 1/8" plywood **forward strut reinforcement plate (FSP)** (the parts are symmetrical, so there isn't a right and a left).

8. Make two 3/8"-thick **aft strut reinforcements** by gluing together two die-cut 1/8" plywood **aft strut reinforcements (RR)** and one die-cut 1/8" plywood **aft strut reinforcement plate (RSP)**. Be certain you make a **right** and a **left**.

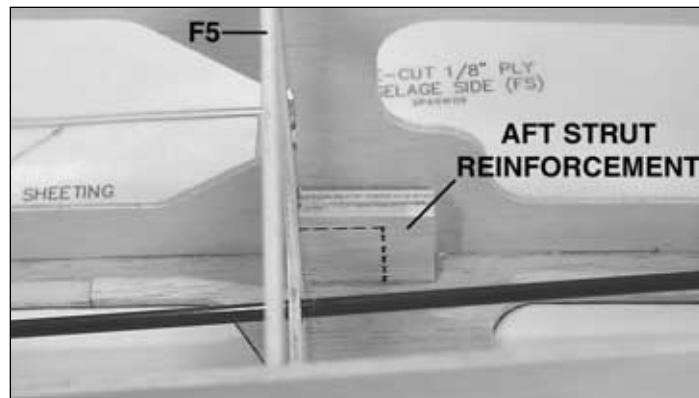
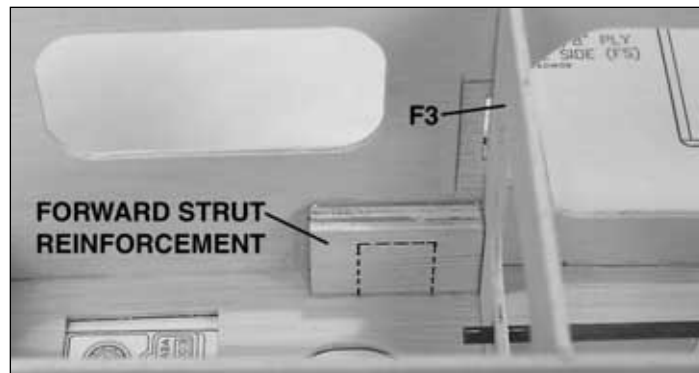

9. Remove the fuse from the building board. Referring to the photo and the fuse plan for the correct orientation, use 30-minute epoxy to glue all four strut reinforcements into position. The dashed lines on the reinforcement plates indicate the position of the reinforcements behind them. **Immediately** proceed to the following step.

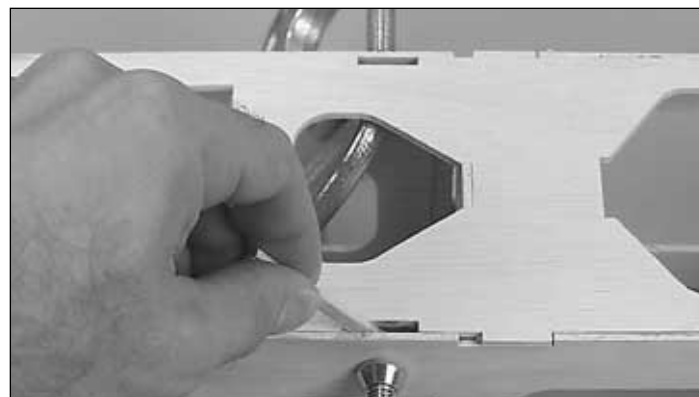

10. **IMPORTANT:** Use leftover balsa sticks to remove epoxy that has been squeezed into the cavity created by the reinforcements and the fuse sides.



11. Reposition the fuse upside-down over the plan. Cut both 36" grey outer pushrod guide tubes to a length of 27", then roughen them with coarse sandpaper so glue will adhere. Install the pushrod tubes in the fuse as shown on the plan. Glue the tubes in the exit slots with 30-minute epoxy and microballoons and glue them to the formers with CA. Later, the tubing and glue will be sanded flush with the fuse sides.

Refer to this photo for the following three steps.

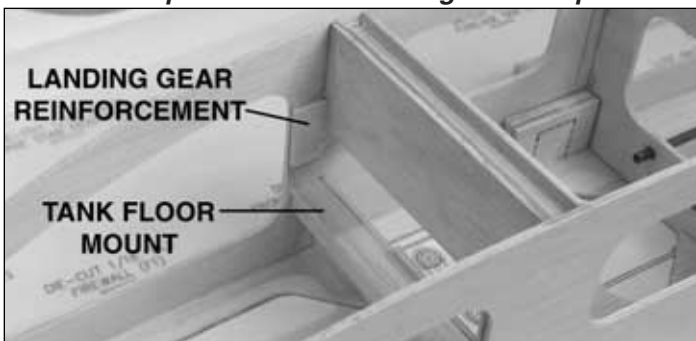

12. Use epoxy to glue together the five die-cut 1/8" plywood **landing gear mount** pieces **L1** through **L5** as shown on the fuselage side-view. Wipe away excess epoxy before it hardens.

13. Cut the **tank floor mount** from a leftover 3/8" x 1/2" balsa stick, then glue it to the front of former F2 where shown on the plan.

14. Use 30-minute epoxy to glue the landing gear mount and both die-cut 1/8" plywood **landing gear reinforcements** to the fuse sides. Note that the bottom of the gear mount should be even with the fuse sides and the gear reinforcements are centered between the edges of the openings in the fuse sides.

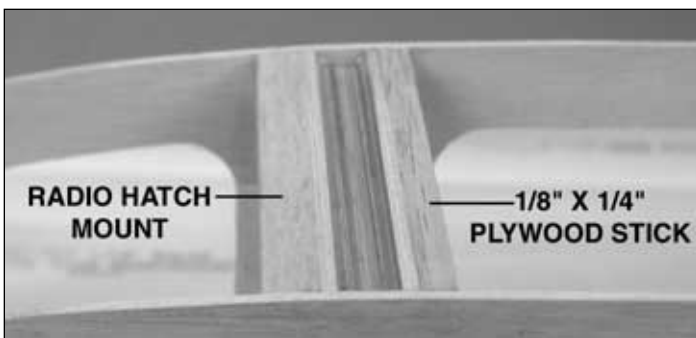

15. Cut the **radio hatch mount** from a leftover 1/2" x 3/8" balsa stick and glue it across the front of the landing gear

mount. Cut the **servo hatch mount** from another leftover 1/2" x 3/8" balsa stick and glue it across the front of former F3. Cut a 1/8" x 1/4" stick to the correct length from leftover 1/8" plywood and glue it across the back of the landing gear mount between the fuse sides. Sand the landing gear mount, hatch mounts and the fuselage formers even with the bottom of the fuse.

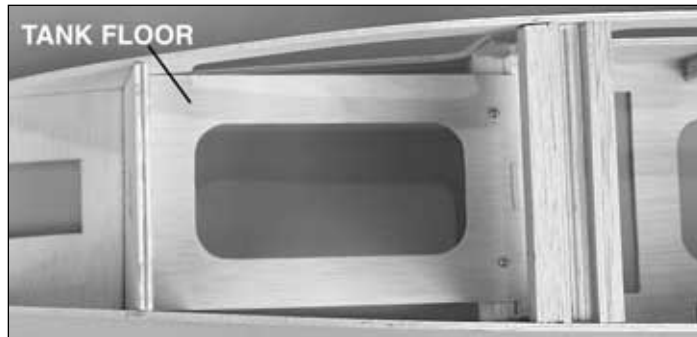

16. Position the die-cut 1/8" plywood **tank floor** F2-B in the fuse, then drill 1/16" holes through the aft end of the tank floor and the tank floor mount. Remove the tank floor. Add a few drops of thin CA to the holes in the tank mount and allow to harden. Enlarge the holes in the tank floor with a 3/32" drill bit. Temporarily mount the tank floor in position with two #2 x 3/8" screws.



17. Sheet the bottom of the fuse from former F3 aft with a 3/32" x 3" x 36" balsa sheet.



18. Use the remainder of the 3/32" x 3" x 36" balsa sheet you used to sheet the fuse bottom, and part of an additional 3/32" x 3" x 36" balsa sheet, to make the **servo hatch**. Make the **catch** from strips of leftover 1/8" plywood and as shown on the plan. Glue a piece of leftover 3/32" balsa to the plywood strip across the aft edge of the landing gear

Refer to the sketch and these photos for the following three steps.

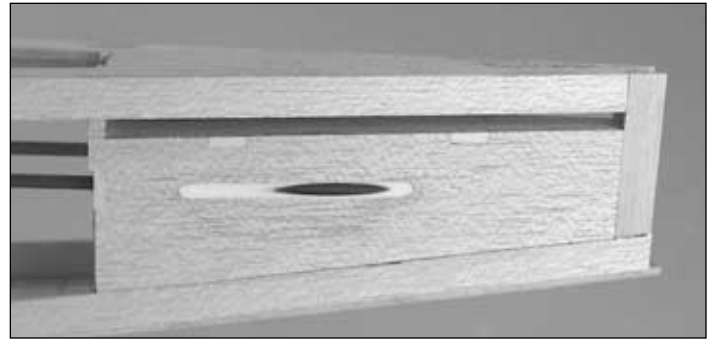
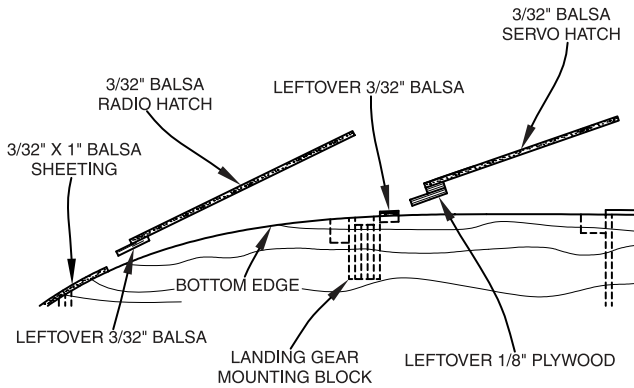

22. Sand the pushrod guide tubes even with the fuse sides.

Join the Fin to the Fuselage

1. If you haven't done so already, final-sand the fin and stab.
2. Temporarily install the stab into the fuse. Measure the distance between both stab tips and the fuse sides. Adjust the stab until both measurements are the same and the stab TE is centered.

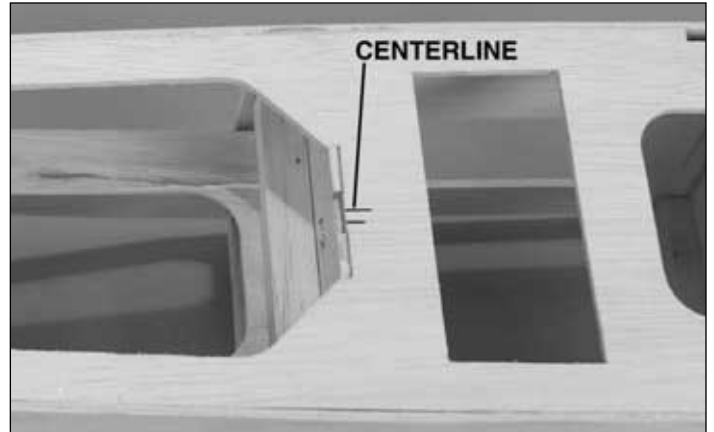

3. Mark a centerline on the exact center of the fuse top over former F2. Mark another line 1/8" to the left of the centerline.

4. Stick a T-pin through the centerline you marked in the top of the fuse over F2. Tie a small loop in one end of a 40" piece of non-elastic string such as monofilament or Kevlar fishing line. Slip the loop in the string over the T-pin.

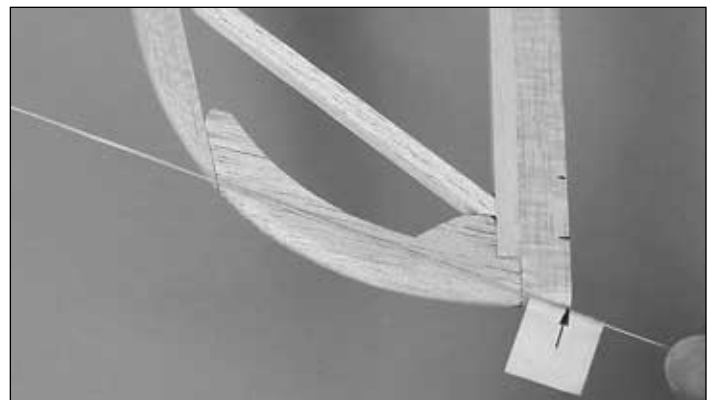

5. Fold a piece of masking tape over the string near the other end and draw an arrow on it. Slide the tape along the

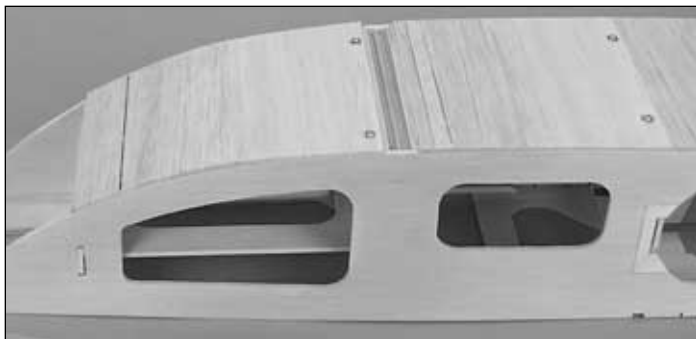
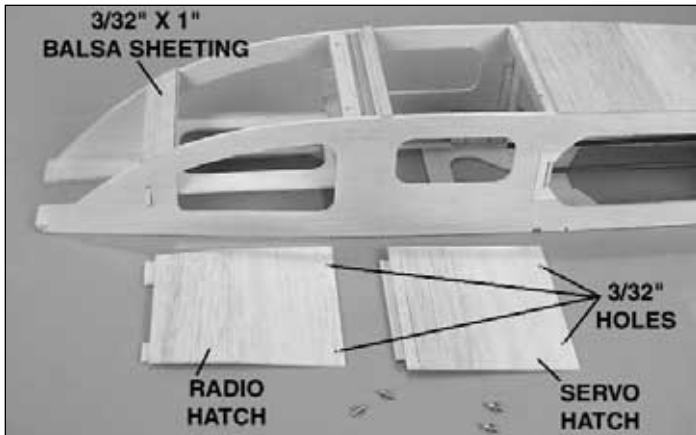

19. Drill two 1/16" holes through the aft end of the servo hatch and the servo hatch mount. Enlarge the holes in the hatch only with a 3/32" drill. Add a drop of thin CA to both holes in the servo hatch mount and allow to harden. Temporarily mount the hatch to the fuse with two #2 x 3/8" screws and #2 washers.

20. Glue a piece of 3/32" x 1" balsa sheeting across the bottom of the fuse from the middle of former F1 aft. Make the **radio hatch** the same way you made the servo hatch, then screw it into position with two #2 x 3/8" screws and #2 washers.

21. Remove the fuselage from the plan. Sand the edges of the bottom sheeting and the hatches even with the fuse sides.

string and align the arrow with one end of the stab as shown in the photo. Swing the string over to the same position on the other end of the stab. While keeping the TE of the stab centered in the fuse, adjust the stab and slide the tape along the string until the arrow aligns with both sides of the stab. Be certain the stab remains centered, side-to-side, during this process.



❑ 6. Lightly mark the top and bottom of the stab along both sides of the fuse, so you will be able to apply the covering up to the line. The lines will serve as a guide for covering and gluing in the stab when it's time.

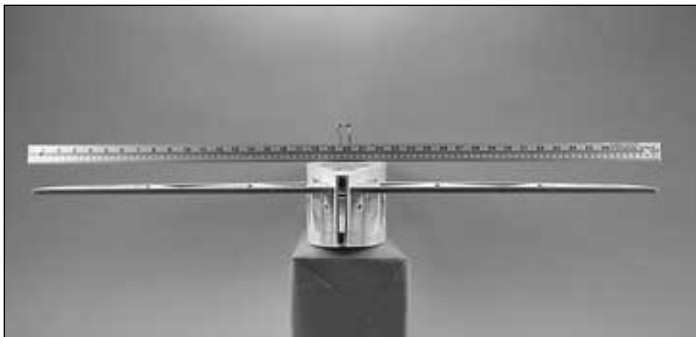

❑ 7. Place a straightedge across the top of the fuse over former F3. View the fuse from about ten feet back and see if the stab is parallel with the straightedge. If it is not, carefully sand the fuse where the stab fits to get it parallel with the straightedge.

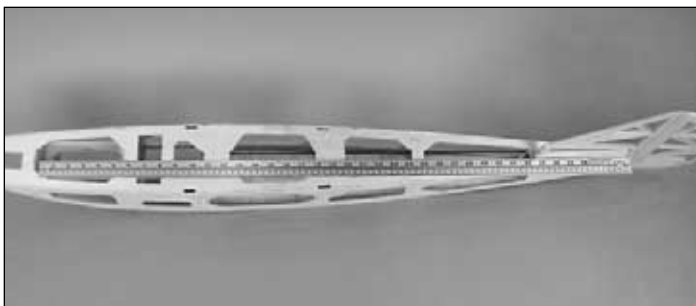

❑ 8. Fit the fin to the fuse. Position a 36" (or longer) straightedge along the left side of the fin. Adjust the straightedge and the fin so the front of the straightedge aligns with the mark you made earlier that is 1/8" left of the centerline. Now the stab is centered laterally. Hold it into position with T-pins.

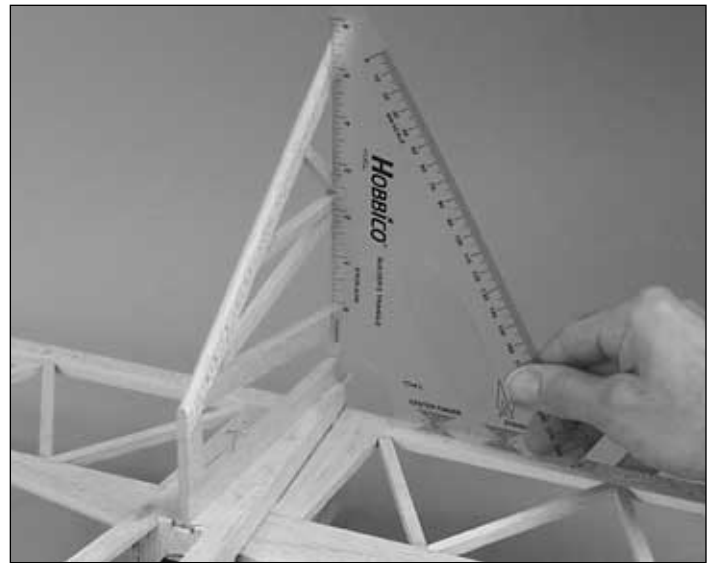

❑ 9. Use 30-minute epoxy to glue the fin to the fuse. Before the epoxy hardens, use a builder's square to make certain the fin is perpendicular to the stab. If necessary, use masking tape to pull the tip of the fin to one side of the stab or the other to get it vertical.

Frame the Top of the Fuselage

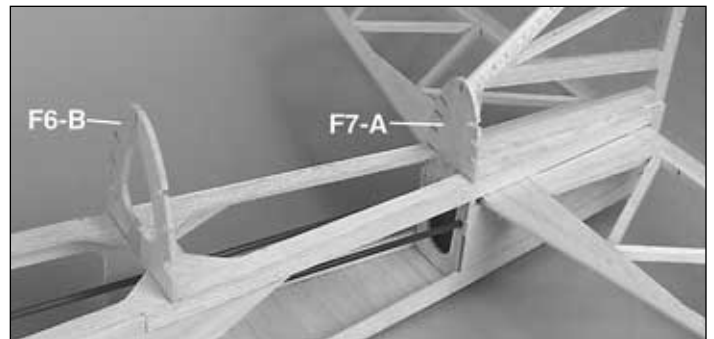

❑ 1. Glue both halves of the die-cut 1/8" balsa **former F6-B** together. Glue former F6-B and the die-cut 1/8" balsa **former F7-A** into position on the fuse top.



❑ 2. Glue a leftover 1/4" x 5/8" balsa stick to the fuse top between the two notches for the aft wing struts. Glue both halves of the die-cut 3/32" balsa **cockpit floor** together. Glue the cockpit floor and the die-cut 1/8" balsa former F4-A into position.

Refer to this photo while gluing in the turtle deck stringers.



3. Test fit, cut, then glue seven 1/8" x 3/8" x 24" balsa **turtle deck stringers** into the notches in formers F6-B and F7-A. The three bottom stringers on both sides of the fuse extend all the way to the TE of the fin.

4. Bevel the inside edges of the stringers to get a good fit to the fin, then glue them to the fin.

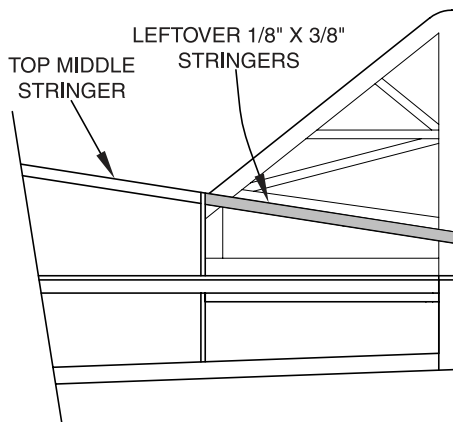

5. Glue leftover 1/8" x 3/8" stringers to both sides of the fin in line with the top, middle stringer. Sand all the stringers even with the fuse sides above the stab. Blend the aft end of the stringers to the fin TE.

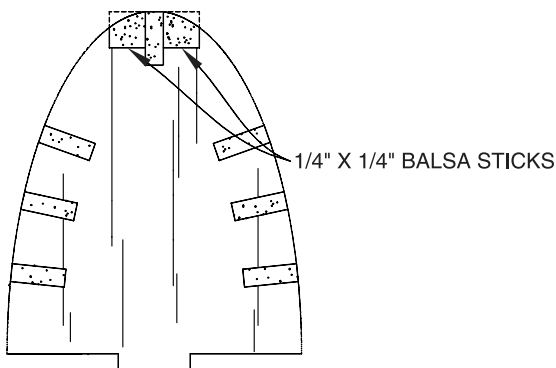

6. Cut a 1/4" x 1/4" x 24" stick to fit on both sides of the top, middle stringer between formers F7-A and F6-B, then glue it into position. Round the stringers to match the shape of the turtle deck.

7. Sand the front of the stringers even with former F-6B. Glue together both halves of the die-cut 3/32" balsa **former F6-A**. Glue F6-A into position.

Refer to this photo for the following three steps.

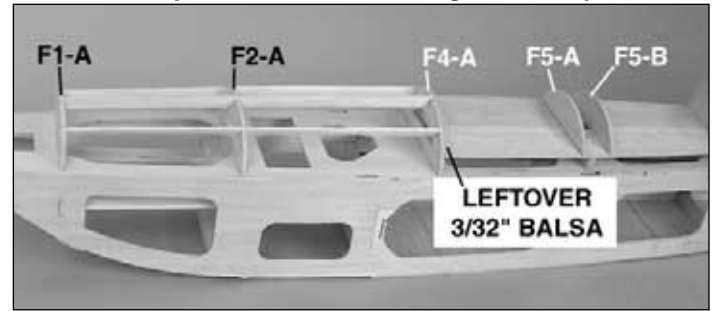

8. Glue the die-cut 1/8" balsa **formers F1-A, F2-A, F5-A and F5-B** into position where shown on the plan. Use a builder's square to be certain the formers are vertical when gluing them into position.

9. From two 1/8" x 3/8" x 30" balsa sticks, cut the three stringers that run from F1-A to F4-A. Glue the stringers into position.

10. Glue a sheet of leftover 3/32" balsa to the aft side of former F4-A and shape it to match the former.

Make the Main Wing Struts

1. Use a hobby knife and a straightedge to accurately cut the **front main strut template** from the fuselage plan.



2. Lightly spray the back of the template with 3M 75 Repositionable spray adhesive or 3M 77 Super spray adhesive. Stick the template to a 3/16" x 3/4" x 6" plywood stick. Spray the other side of the ply stick with spray adhesive and stick it to another 3/16" x 3/4" x 6" plywood stick.

3. Use a razor saw to cut the notch in one end of the front main struts, and use a bar sander with 80-grit sandpaper to sand the bevel on the other end of the front main struts.

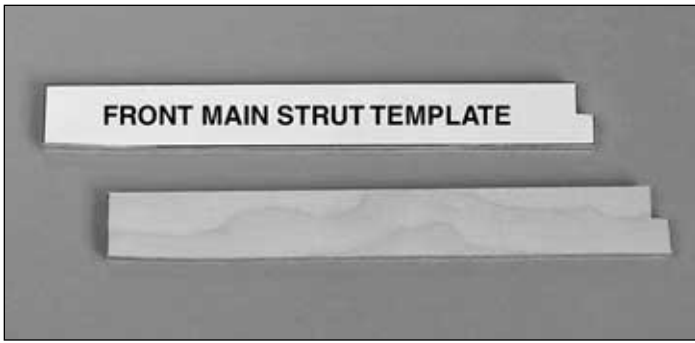

❑ 4. Separate the struts. Use cigarette lighter fuel or other solvent to remove the template and wash the spray adhesive from the struts. Mark the struts as “F” for front.

❑ 5. Use the **rear main strut template** to make two **rear main struts** the same as you made the front main struts. Mark the rear main struts as “R.” Make one **front support** and one **rear support** using the templates provided on the plan and two more 3/16" x 3/4" x 6" plywood sticks.

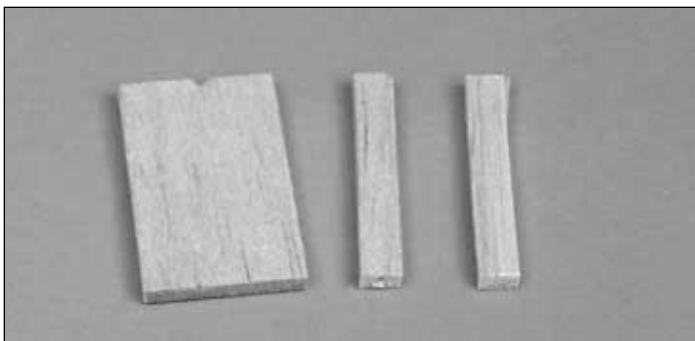

❑ 6. Cut one 1" x 1-3/4" piece and two 1/4" x 1-3/4" pieces from leftover 1/8" balsa.

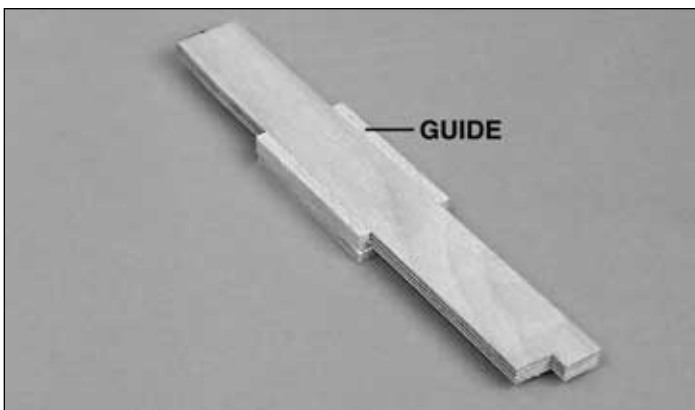

❑ 7. Build a **guide** around one of the front main struts from the balsa pieces you cut in the previous step. Be careful not to glue the strut to the guide. Sand the 1/4" pieces even with the strut.

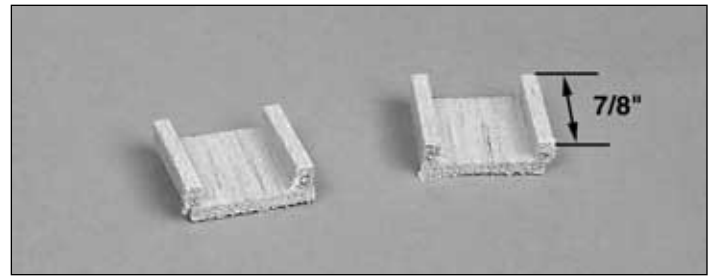

❑ 8. Remove the guide from the strut, then cut it into two 7/8" pieces.

Refer to this photo for the following three steps.

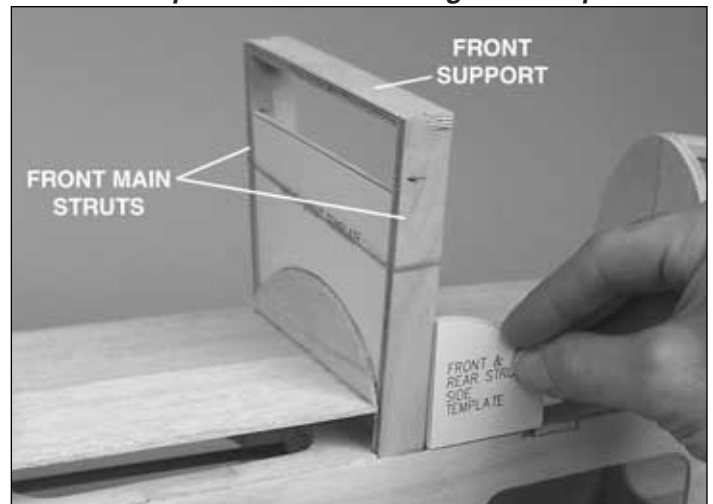

❑ 9. Test fit the front main struts into the pockets on both sides of the fuselage. If necessary, enlarge the notches in the fuse top to accommodate the struts. Be certain the struts are positioned as shown on the plan.

❑ 10. Position the front support on top of the front main struts. Use rubber bands to hold the main struts to the support.

❑ 11. Use spray adhesive to glue the **main strut side template**, the **front main strut template** and the **rear main strut template** to a piece of thin cardboard or plywood (not supplied). Cut out the strut templates. Use the front main strut template and the side main strut template to position the front main struts as shown.

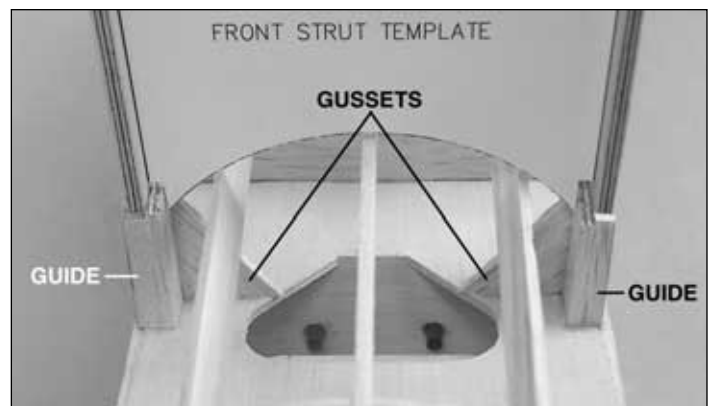

❑ 12. Position the guides on the front main struts. Use the templates to be certain the struts are set correctly, then glue

the guides to the fuse top, but not to the struts. Make **gussets** from leftover 1/8" balsa to support the guides, then glue the gussets into position.

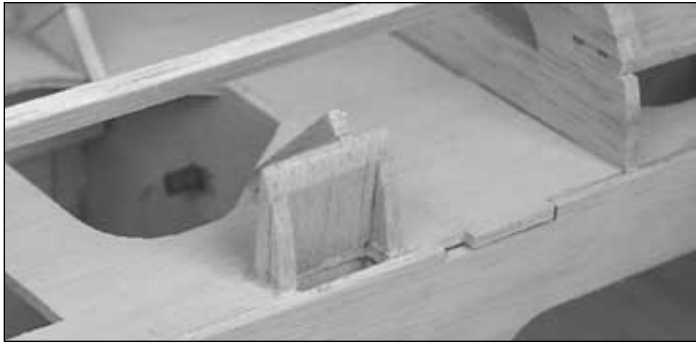

❑ 13. Remove the main struts from the fuse. Using the formers as a guide, carefully sand the guides even with the curvature of the fuse.

❑ 14. Fit the **rear** main struts to the fuse and the rear support to the top of the struts. Use the rear main strut template and the main strut side template to set the main struts at the correct angle. Notch the cockpit floor as necessary.

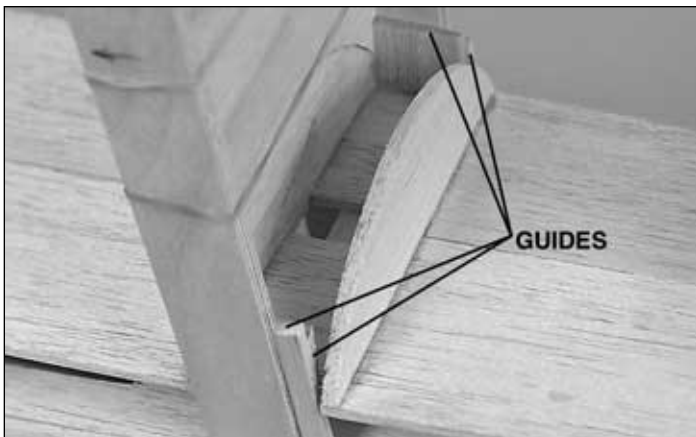

❑ 15. Use leftover 1/8" balsa to build guides around the inside edge and the aft edge of the rear main struts. Use care not to glue the struts to the guides or to the fuse. (The photo of the finished guides in the following step will provide additional information on how to construct them.)



❑ 16. Remove the rear main struts. Sand the guides even with the rounded shape of the formers.

The fuse could be sheeted now, but first let's mount the engine and fuel tank, while most of the inside is still accessible.

Mount the Engine

❑ 1. Sand the front of the engine mount even with the bottom of the fuse sides.

❑ 2. Test fit your engine to the engine mount. If necessary, widen the mount to accommodate the engine.



❑ 3. Use a Great Planes Dead Center Hole Locator (GPMR8130) or something similar to mark the location of the mounting holes onto the engine mount.

❑ 4. Drill 1/8" holes through the engine mount where you marked the holes. Use a 4-40 x 3/4" SHCS (socket-head cap screw) with a #4 washer to draw four 4-40 blind nuts into the holes in the bottom of the engine mount. Use a few drops of CA to permanently glue the blind nuts into position. Harden the top surface of the mount where the engine mounting lugs rest by applying thin CA to the area and allowing it to fully harden before mounting the engine.

❑ 5. Temporarily mount the engine to the fuse with four 4-40 x 3/4" screws and four #4 washers. Place two additional #4 washers on each rear mounting screw under the engine to provide the correct down thrust.

❑ 6. Assemble the fuel tank per the instructions included with the tank. Be certain the weight at the end of the fuel pick-up line inside the tank cannot contact the back of the tank. Otherwise, it may become stuck above the fuel level and discontinue fuel flow. Mount the tank to the tank floor with R/C foam rubber and rubber bands (use a few additional rubber bands for mounting the battery pack and receiver later on). Reinsert the tank and tank mount into the fuse.



❑ 7. Drill 1/4" holes through former F1-A to pass the fuel lines. Temporarily connect the fuel lines to the tank and route them through the former to make sure the holes are in the correct location.

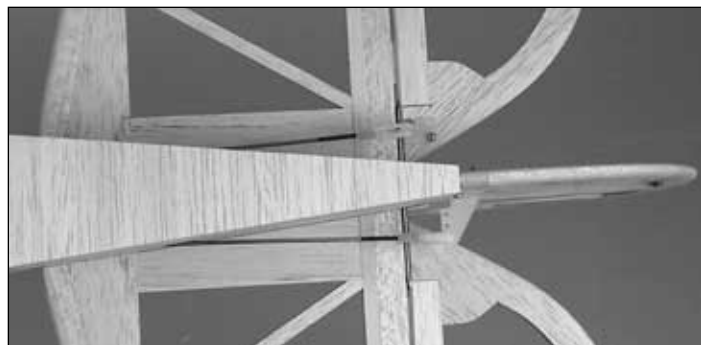

❑ 4. The same way you did the ailerons, connect the elevator and rudder to the servos using the pushrods and hardware shown on the plan. Use 2-56 x 5/8" screws to secure the large control horns to the rudder and elevator.

❑ 5. Drill a 3/16" hole through F1-A for the throttle pushrod guide tube. If using the O.S.® MAX LA .40, the location of the hole is shown on the fuse plan in the cross-section at F1-A. If using a different engine, drill the hole so the throttle pushrod will align with the arm on the carburetor.

❑ 6. Use one of the guide tubes leftover from the elevator or rudder pushrod for the throttle. Roughen the tube with coarse sandpaper so glue will adhere, then glue it into position. Connect the throttle servo to the carb using a pushrod with a nylon clevis on the carb arm and a brass screw-lock pushrod connector with a nylon retainer and a 4-40 x 1/8" screw on the servo arm.

Connect the Pushrods

❑ 1. Cut two 3/8" x 4" **servo mount doublers** from leftover 1/8" plywood. Glue the doublers to the top of the forward fuse top at the edges of the opening for the servos. Position the servos in the fuselage as shown on the plan. Drill 1/16" holes for mounting the servos, then mount the servos to the fuse with the screws included with the servos.



❑ 2. Cut a slot in the fin TE where shown on the plan to accommodate the nylon tail gear mount. Trim the rudder LE to accommodate the mount, then drill a 3/32" hole for the tail gear. Temporarily mount the tail gear and the rudder to the fuse.

❑ 3. If the stab and elevators are not already on the fuse, temporarily join them with the hinges so you can make the pushrods.

Sheet the Top of the Fuselage

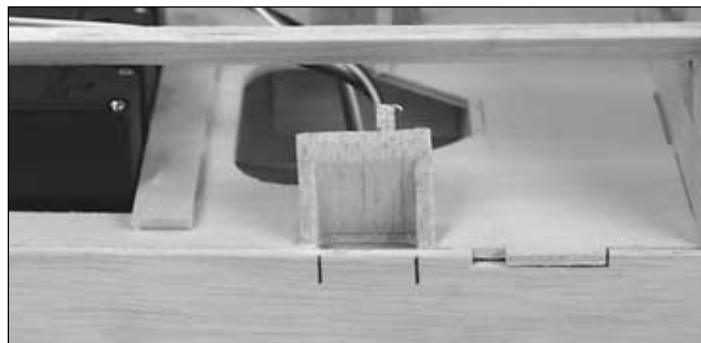

❑ 1. Mark the location of the front and rear wing struts on both sides of the fuselage.



❑ 2. Cut a 3/32" x 4" x 30" balsa sheet into two 15" pieces. Use both sheets to sheet one side, then the other side of the front of the fuselage from former F1-A to F4-A. **Hint:** Before

gluing the first sheet into position, use it as a pattern to make the second sheet. Wet the outside of the sheets with window cleaner to help them bend easier.

- ❑ 3. Use the **cockpit sheeting template** on the plan to make the two cockpit sheets from the remaining 3/32" x 4" x 30" balsa sheet. **Note:** Make the sheets slightly larger than the template to allow for trimming to exact size.

For the best appearance, it is easiest to paint the cockpit floor and instrument panels now, before enclosing the cockpit. You could glue 600-grit sandpaper to the cockpit floor and paint the instrument panels black, then apply the instrument panel decals, or use your own methods to finish the cockpits.

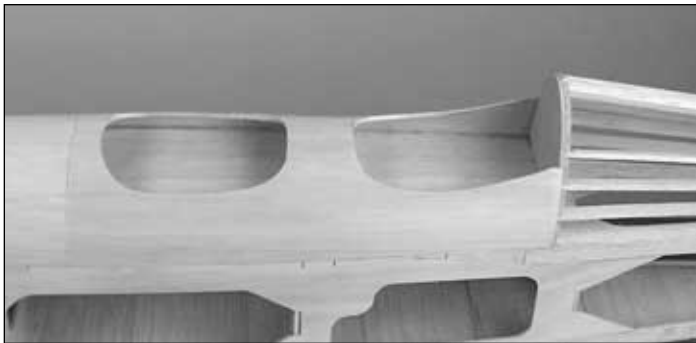

- ❑ 4. Test fit, then trim one of the cockpit sheets to the correct size, then glue it into position. Glue the other cockpit sheet into position.

- ❑ 5. Use lightweight balsa filler where needed to fill any gaps and allow to dry.

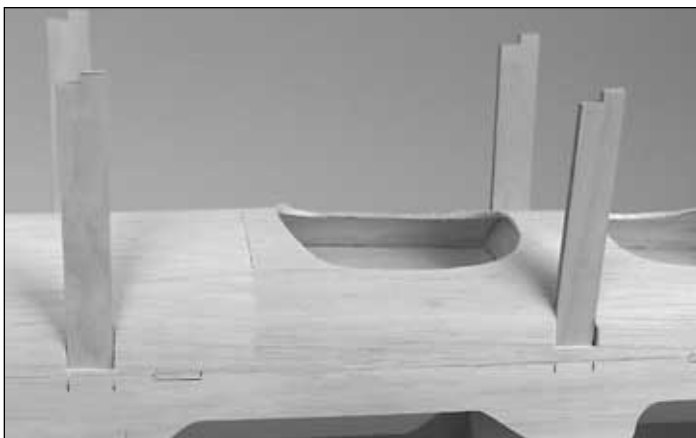

- ❑ 6. Trim the sheeting as necessary to accommodate the wing struts. Test fit the wing struts into the fuse.

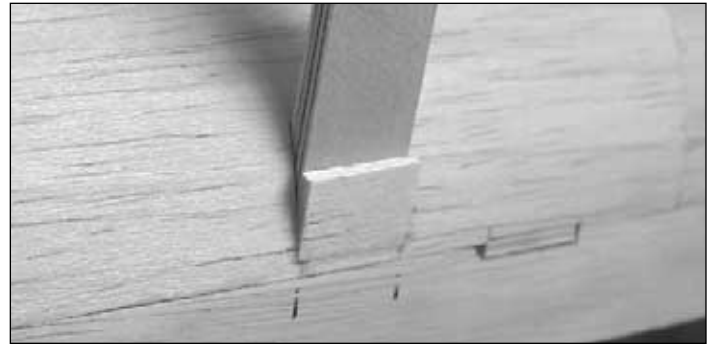

- ❑ 7. With the wing struts temporarily installed in the fuse, carefully glue leftover pieces of 3/32" balsa to the fuse sheeting over the struts.

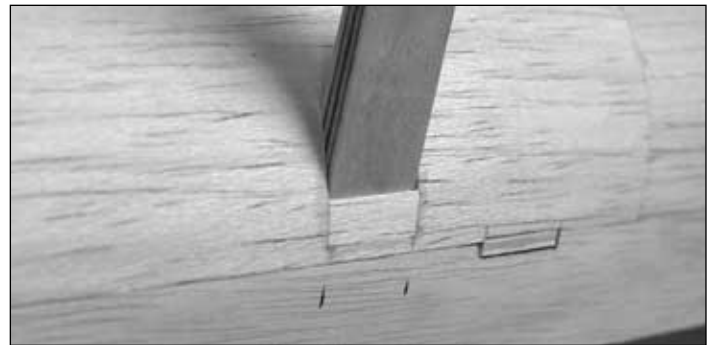

- ❑ 8. Remove the struts, then sand the leftover pieces of balsa to the shape of the fuse. Sand the rest of the fuse sheeting even and smooth. Reinstall the struts to see how it all looks!

Mount the Landing Gear

Refer to this photo to mount the landing gear.

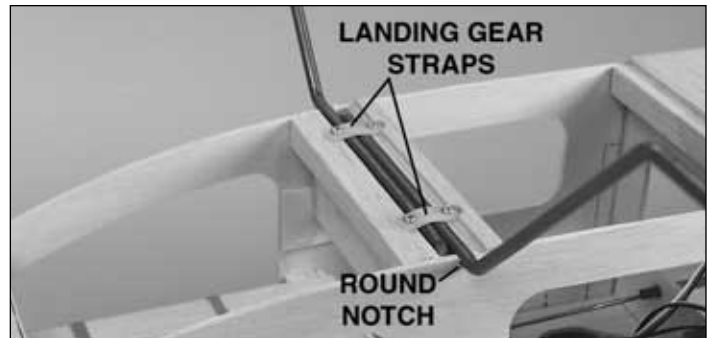

- ❑ 1. Drill #8 (or 3/16") holes into the landing gear mount where shown on the plan for the prebent 3/16" landing gear wires. Chamfer the edges of the holes so the wires can go all the way in, then cut round notches in the fuse sides to accommodate the gear.

- ❑ 2. Use a rotary tool with a cut-off wheel, or a metal file to chamfer the ends of the landing gear wires to remove burrs. Test fit the gear into the mounts. Make adjustments where necessary.

- ❑ 3. Remove the landing gear wires. Position the nylon landing gear straps on the landing gear mounts so the holes

in the straps will be centered over the outer ply pieces. It may be necessary to trim part of the bottom sheeting to accommodate the straps.

❑ 4. Drill 1/16" holes into the landing gear mounts for the screws that hold the straps. Screw four #2 x 1/2" screws into the holes, then remove the screws. Add a few drops of thin CA to the holes and allow to fully harden.

❑ 5. Temporarily mount the gear to the fuse with the straps and screws.

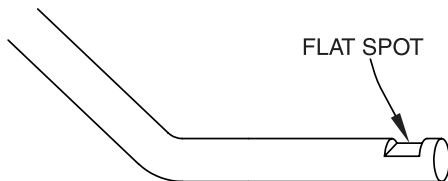

❑ 6. If necessary, enlarge the holes in the wheels you will be using with a #8 drill. File a flat spot on the landing gear wire for the set screw that holds the outer wheel collar on. Mount the wheels to the gear with four 3/16" wheel collars and set screws (one wheel collar on each side of both wheels).

❑ 7. While you're at it, mount a 1" tail wheel on the tail gear and secure it with a 3/32" wheel collar and a set screw.



❑ 8. Use the pattern provided on the plan to make the **landing gear covers** from leftover 3/32" balsa. Glue strips of leftover 1/8" balsa to the back of the covers to form a "U" channel that will position and help secure the covers to the gear. Test fit the covers to the gear. Make adjustments where necessary for a good fit. After the landing gear covers are ...covered, they will be secured to the landing gear with RTV silicone sealer.

While the fuselage is upside-down, let's finish up the bottom under the engine.

❑ 9. Remove the engine. Use epoxy or fuelproof paint to coat the engine compartment under the engine mount. Be careful not to get any paint into the blind nuts.

❑ 10. Cut a piece of leftover 3/32" balsa to fit the bottom of the fuse under the engine. Fuelproof the inside of the sheet, then glue it into position.

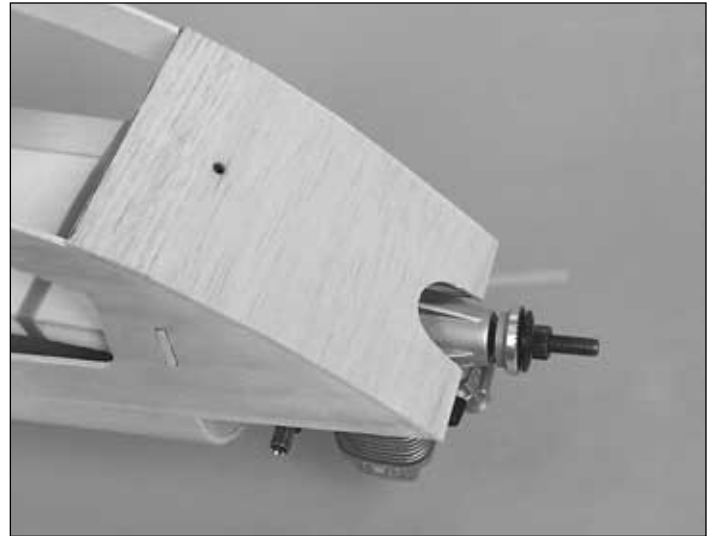

❑ 11. Sand the sheeting even with the fuse sides. Trim the front of the sheeting to accommodate the engine. (Note the drainage hole drilled so spilled fuel does not collect in the compartment.)

❑ 12. While you have your fuelproof paint out, remove the landing gear and fuelproof the groove in the landing gear mount and the engine mount.

Join the Main Wing Struts

Note: The main wing struts will be glued to the supports (the horizontal ply sticks that the wing bolts to), but the wing struts will not be glued into the fuse until after the model has been covered.

❑ 1. Shape the edges of the wing struts to your preference. You could leave the edges square or slightly round them (as we have done on the model in the photos).

❑ 2. Temporarily fit the struts into the fuse. Position the front and rear supports on top of the struts. Place the forward and aft strut templates between the struts, then place rubber bands around the struts to hold it all together.

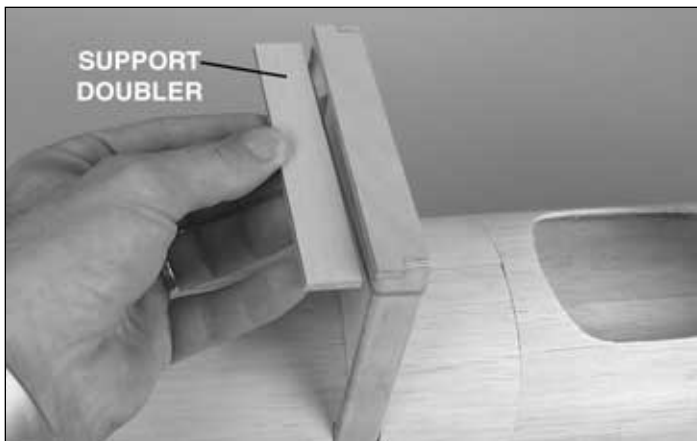

3. Cut the **support doublers** to fit under the supports from the remaining 3/16" x 3/4" x 6" plywood sticks.

4. Use epoxy to glue the support doublers to the supports.

5. Raise the stab approximately 7" off your workbench by placing blocks under the aft end of the fuselage. Without using any glue, fit the supports to the struts. Place the wing on top of the supports and place weights on top of the wing to hold it in place.

Refer to this sketch for the following two steps.

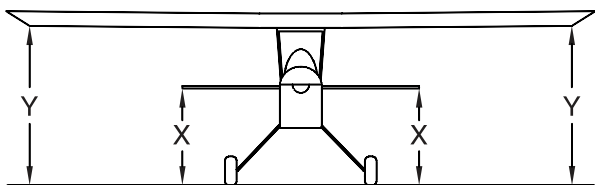

6. Measure the distance between both stab tips and the workbench (as indicated by the "X" in the sketch). Place balsa sheets under one of the wheels until the distances between both stab tips and the workbench are the same and the stab is level (parallel with the workbench).

7. Measure the distance between both ends of the wing under rib W6 and the workbench (as indicated by the "Y" in the sketch). If the distances between both wing tips and the workbench are the same, then the wing is in alignment with the stab. If the distances between both wing tips and the workbench are not the same, remove the wing and the wing struts. Sand the bottom of the taller struts until the wing aligns with the stab.



8. Use 30-minute epoxy to glue the front and rear supports to the struts. For additional strength, add Great Planes

Milled Fiberglass (GPMR6165) to the epoxy. Wipe away excess epoxy before it hardens and do not disturb the model. **Note:** Although the struts go into the fuselage at an angle, they are still removable after the supports are glued on.

The length of the wing struts determines the wing incidence. The wing incidence has a **great** effect on how the model flies. Although you have cut the wing struts using the templates provided, there is still the possibility for small building errors which could change the intended wing incidence. We **strongly** urge you to check the wing incidence using an incidence meter before permanently gluing the struts into the fuselage. If you do not have an incidence meter at your immediate disposal, you may still proceed with construction as long as you get one and measure the wing incidence before permanently gluing the struts into position.

The wing incidence shown on the plan is in relation to the stab, which is zero degrees. The wing incidence is positive 1 degree.

Now that the wing has been aligned with the stab, and the supports have been glued into position, it's time to check the wing incidence.

9. With the wing struts in position, rest the wing on top of the supports. Lay weights on top of the wing to hold it down.

10. Place a Great Planes AccuPoint™ Laser Incidence Meter, or another incidence meter suitable for measuring incidences of model airplanes, on the stab. Be certain the elevator is neutral (you may clamp strips of hardwood or a straightedge across the stab and elevator to ensure that the stab is centered). Use blocks of wood or something similar to block-up the aft end of the fuselage until the stab is level and the incidence meter reads zero.

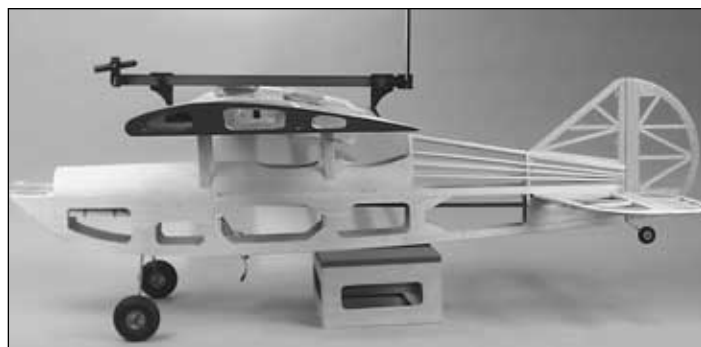

11. Without disturbing the model, remove the incidence meter from the stab and place it on the center-section of the wing. Read the incidence. If it reads one degree positive the incidence is correct. If the reading on the wing is less than one degree, the **aft** wing struts must be shortened to lower the trailing edge of the wing until the correct wing incidence is achieved. If the reading on the wing is more than one degree, the **front** struts must be shortened to lower the leading edge of the wing until the correct wing incidence is achieved. Adjust the length of the front or aft struts by trimming both sides equally at the bottom until the wing incidence is one degree. **Note:** A 1/16" change in the length

of the struts equals an approximately one degree change in incidence.

- ❑ 12. Mark the exact center of the aft support where the wing bolt hole will be drilled.

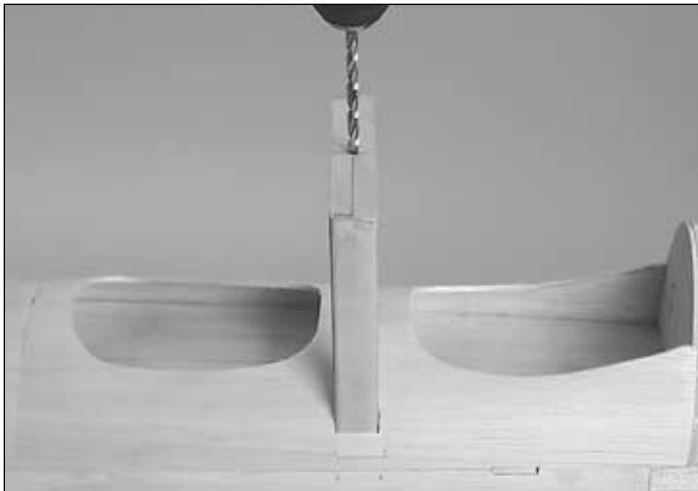

- ❑ 13. Use a #7 drill to drill a hole through the center of the aft strut. Use a 1/4-20 tap to cut threads into the hole.

- ❑ 14. Place the wing on the struts. Bolt the wing to the aft strut with a 1/4-20 nylon wing bolt (you may cut the bolt to a length of 1-1/8"), but do not tighten the bolt all the way.

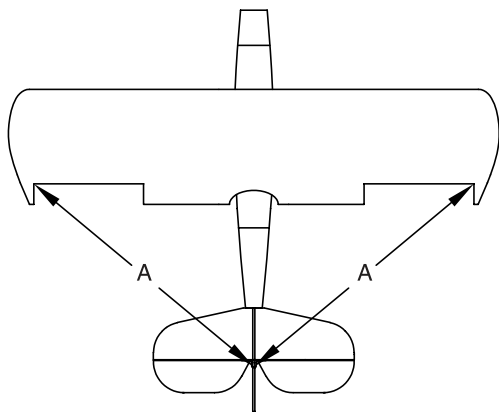

- ❑ 15. Measure the distance between both wing tips and the end of the fuse. Rotate the wing about the aft wing bolt until the distances are equal and the wing is centered as indicated by "A" = "A" in the sketch.

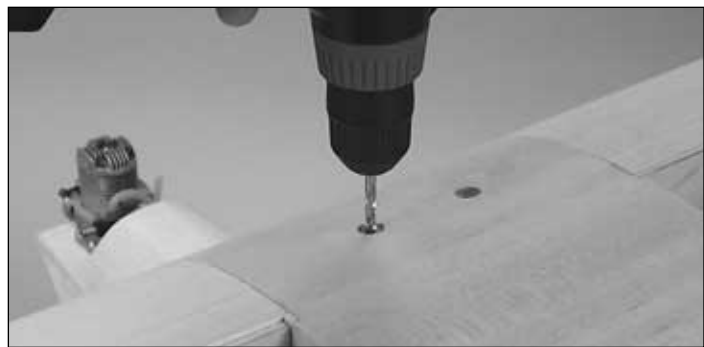

- ❑ 16. Once you have achieved the correct alignment, hold the wing in position and drill #7 holes through the forward supports using the holes in the wing as a guide. Tap 1/4-20 threads into the support. Add a few drops of thin CA to the holes in both supports and allow to fully harden. Re-tap the threads.

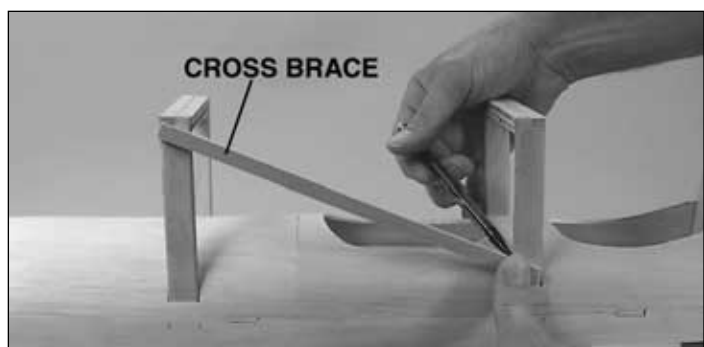

- ❑ 17. Before bolting the wing into position, cut two 10" **cross braces** from the 3/16" x 3/8" x 20" basswood stick. Hold one of the cross braces up to the main wing struts, then mark where it is to be cut to fit between the struts as shown on the plan.

- ❑ 18. Mark the other cross brace for the other side of the struts the same way.



- ❑ 19. Mount the wing to the supports. Cut the cross braces where you marked them. Test fit the cross braces between the struts to make sure they fit well. Make adjustments where necessary. The cross braces will be glued to the main wing struts after the fuselage has been covered and the main wing struts have been glued into position.

- ❑ 20. Round the corners of the cross braces just the same as you did for the main wing struts.

- ❑ 21. Cut the hole in the bottom of the center-section where shown on the plan for the aileron servo wires.

FINAL CONSTRUCTION

Build the Static Wing Struts

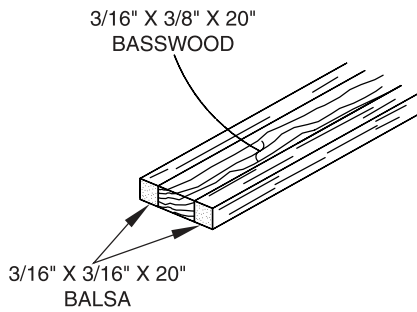

1. Make a **static wing strut** by gluing two 3/16" x 3/16" x 20" balsa sticks to one 3/16" x 3/8" x 20" basswood stick. Cut the static wing strut to a length of 19-3/16".

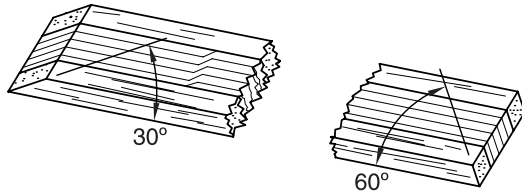

2. Use the detailed drawing of the static wing strut on the wing plan as a template to cut the angles on the ends of the strut.



3. Use a #11 blade to bevel the opening in the 1/8" ply wing strut support in the right wing half.



4. Fit the top of the static strut into the wing strut support in the right wing, then fit the bottom of the static strut into the fuse as you bolt the wing into position. See if the static struts are at correct length (they will most likely be slightly too long, as this allows for trimming to the correct length). If necessary, remove the wing and the strut. Trim the strut to the correct length so it does not put any stress on the bottom fuse sheeting or the wing. The strut is not functional and should be slightly loose so it can "float" between the wing and fuse.

5. Round the edges of the strut for a finished appearance.

6. Once you have determined the correct length of the static strut, build the other the same way. **Note:** The static struts are not structural, but are intended to be in position during flight for appearance.

Prepare the Model for Covering

1. Disassemble the model and remove all components that will interfere with final sanding and covering, such as the engine, landing gear, pushrods, hinges, etc.

2. Apply lightweight balsa filler to scratches, dents and uneven glue joints that require filler. Before applying filler to small dents and scratches, moisten the area with water, causing the wood to swell.

3. After the filler has dried, final-sand all parts of the model with progressively finer grits of sandpaper, finishing with 400-grit.

4. Use compressed air, a dust brush, or a tack-cloth to remove balsa dust from the model so the covering will adhere well.

5. If you haven't done so already, paint the cockpit interiors with fuelproof paint. It is best to do this before covering the model, as it is possible for paint to "bleed" through the balsa sheeting and contact the back of the covering. If this happens, some paints can cause blemishes in the covering.

Cover the Model

Cover the model following the suggested covering sequence.

Tail Surfaces:

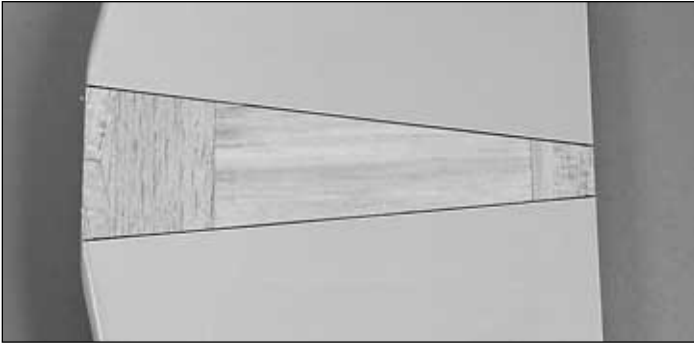

- 1. Bottom, then the top up to the lines you marked, leaving the center uncovered for gluing to the fuse. Cut the covering over the vent-holes drilled near the tips so heated air can escape.
- 2. Bottom, then the top of the elevators.
- 3. Rudder. (The fin will be covered after the fuselage is covered.)

Fuselage:

- 1. Hatches
- 2. Bottom
- 3. Sides
- 4. Fin
- 5. Landing gear covers

Wing:

- 1. Circular cut-out in the trailing edge of the center-section.
- 2. Bottom of wing tips.
- 3. Bottom of wing.
- 4. Top of wing.
- 5. Ailerons.
- 6. Cover (or paint) the static struts.

Glue the Main Wing Struts into Position

Now that the fuselage has been covered, it's finally time to glue the main wing struts to the fuse. But first, the stab must be glued into position so the wing incidence can be confirmed.

- 1. Use 30-minute epoxy to glue the stab into the fuse. Use the "pin-and-string" technique to confirm that the stab is aligned and centered just the same as you did while building the model. Use a tissue dampened with alcohol or other solvent to wipe away excess epoxy before it hardens.
- 2. Trim the covering from the fuse where the main wing struts fit.
- 3. Temporarily join the elevators to the stab with the hinges. Place the incidence meter on the stab, being certain

that the elevator remains centered. The same as was done before, raise the aft end of the fuse so the stab is level and the incidence meter reads zero.

During the next two steps it will be important to proceed rapidly, so the correct wing incidence can be finalized.

- 1. Mix up a batch of 30-minute epoxy. Thoroughly coat the main wing struts and the insides of the "pockets" in the fuse where the struts go. Fit the struts into the fuse.
- 2. Bolt the wing to the struts. Confirm that the stab is still set at zero degrees. Attach the incidence meter to the wing and measure the incidence. It should read 1 degree positive, just the same as when you were building the struts during construction. If necessary, raise the front or aft struts slightly to achieve one degree of wing incidence when the stab is zero. Wipe away excess epoxy before it hardens and do not disturb the model.
- 3. After the epoxy has fully hardened, finish-sand the cross braces, rounding the corners to match the main wing struts. Remove the wing from the fuse. Place waxed paper on top of the forward support, then bolt the wing back to the fuse. Use 30-minute epoxy to glue the cross braces to the main wing struts as shown on the plan and in the photo at step 19 on page 32.



- 4. Remove the wing from the struts. Paint the struts with fuelproof paint. It is best to brush-paint the struts. If you only have spray paint (such as Top Flite LustreKote®), spray the paint through a tube (to keep most of it from becoming airborne) into a cup. Do this in a well ventilated area. Allow LustreKote to sit for about 30 minutes before brushing it onto the struts.
- 5. While you have some fuelproof paint ready, coat the engine mount and the front of former F1-A. Coat other areas of the model that require protection from engine exhaust such as the grooves in the main landing gear mounts, the holes near the bottom of the fuse for the static struts, the cockpits (if you haven't done so already), the fuel tank area and the inside of the hatches.

Finish the Cockpits

- 1. If you haven't done so already, paint the cockpit interior with fuelproof paint. Cut out the instrument panel decals and

install them on the instrument panels. Paint a pilot(s) of your choice and securely glue him into position. If you use only one pilot, place him in the aft cockpit.

❑ 2. Use the windshield pattern on the plan to make two windshields from the .02" x 3-1/2" x 12" clear plastic sheet. After cutting out the **windshields**, sand the edges smooth with 320-grit sandpaper.



❑ 3. Position one of the windshields on the fuselage. Use a fine-point felt-tip pen to trace the outline of the windshield onto the covering. Trim the covering from the model along the line you marked.

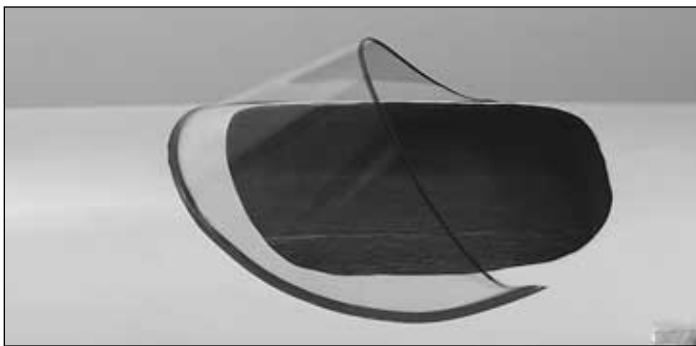

❑ 4. Use canopy glue such as J & Z Products Z R/C 56 (JOZR5007) or CA to glue one of the windshields to the fuse. If you use CA be careful not to use too much as it will "fog" the plastic around the glue joint. Do not use CA accelerator. Add 1/8" striping tape where the canopy meets the fuse.

❑ 5. Glue the other windshield to the fuse the same way.

Join the Control Surfaces

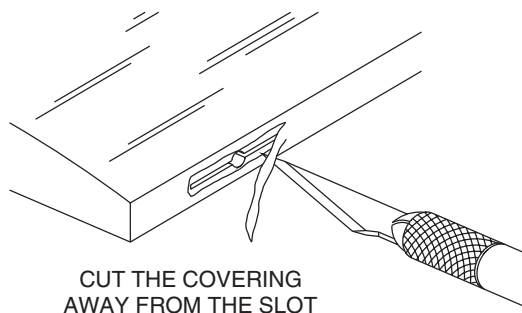

❑ 1. Starting with the stab and the elevators, remove a small strip of covering from each hinge slot. Do not simply

cut slots in the covering, but remove a small strip of covering so it will not interfere with the CA when gluing in the hinges.

❑ 2. Roughen the elevator joiner wire with coarse sandpaper so glue will adhere. Insert the joiner wire into the fuse.

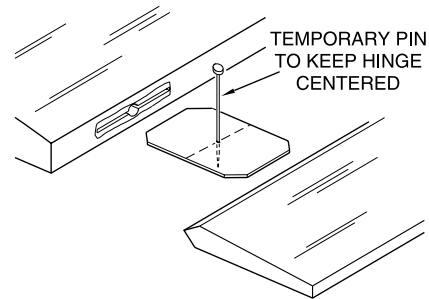

❑ 3. Test fit the elevators to the stab and the joiner wire with the hinges. If any of the hinges do not stay centered, temporarily insert a pin into the middle of the hinge to keep it centered.

❑ 4. Use a piece of leftover pushrod wire or a toothpick to thoroughly coat the inside of the holes and the grooves in both elevators with 30-minute epoxy. Join the elevators to the joiner wire and the stab with the hinges. Use a piece of a paper towel or a tissue dampened with alcohol or other suitable solvent to wipe away excess epoxy. **Hint:** Before joining the elevators to the stab, remove the hinges. Add a few drops of household oil to a tissue and wipe it along the TE of the stab and the LE of the elevators, **lightly** coating the surfaces with a **fine** film of oil. This will keep excess CA and epoxy from gluing the elevators to the stab.

❑ 5. Remove any pins you may have used to keep the hinges centered. Be certain there is a **small** gap between the elevators and the stab—just enough to slip a piece of paper through or to see light through. Add four to six drops of thin CA to the top and bottom of each hinge. Wait a few seconds between drops to allow the CA to fully soak in.

❑ 6. Add a drop of oil or a dab of petroleum jelly to the tail gear wire where it fits into the nylon tail gear mount. Glue the nylon tail gear mount into the fin TE with 30-minute epoxy. Coat the hole in the rudder for the tail gear wire with epoxy. Join the rudder to the fin with the hinges. Add four to six drops of thin CA to both sides of each hinge.

❑ 7. Join the ailerons to the wing the same way.

Hook Up the Controls

❑ 1. Mount the engine and reinstall the servos and all the hardware you removed before covering the model. Don't forget about the washers under the rear of the engine to set the correct down thrust. If you haven't done so already, cut a hole in the bottom of the center-section of the wing where shown on the plan to pass the aileron servo wire.

❑ 2. Connect servo extension cords to the aileron servos. We used one Hobbico 6" extension cord (HCAM2000) for

each servo. Secure the connection between the extension cord and the servo with tape or clips intended for that purpose.

3. Use the strings you previously built into the wing to pull the extension cords through the hole in the bottom of the center-section of the wing. Connect the extension cords to a "Y" connector. We used a Futaba AEC-13 Dual extension cord (FUTM4130).

4. Cut a hole through the fuse sheeting in an inconspicuous location where you can route an aileron servo wire up to the servo wire coming from the wing. On our model we cut this hole just inside the right front main wing strut.

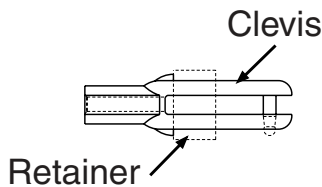

5. Connect all the pushrods to the control surfaces. Be certain to install the screws that hold the servo arms to the servos and use silicone retainers to secure the clevises to the horns on the control surfaces. Add a drop of thread locking compound to the screw that holds the throttle pushrod to the brass pushrod retainer on the throttle servo, then tighten the screw.

6. Mount the main landing gear with the screws and landing gear straps the same way you did before. Secure the landing gear covers to the landing gear wire with RTV silicone adhesive.

7. If you haven't done so already, securely mount the wheels to the landing gear with the wheel collars and set screws. Before installing the set screws into the wheel collars, add a drop of thread locking compound to each set screw, then tighten. Be certain you have filed flat spots on the landing gear wire for the wheel collars that hold the wheels on.

8. Mount the receiver and battery pack where shown on the plan. Use R/C foam rubber to cushion the receiver and battery and securely mount them to the bottom of the fuel tank floor. You can use the same rubber bands that hold the tank to the top of the floor, or use additional rubber bands.

9. Mount the on/off switch to the left fuselage side (opposite the engine exhaust) in a location that will not interfere with other components.

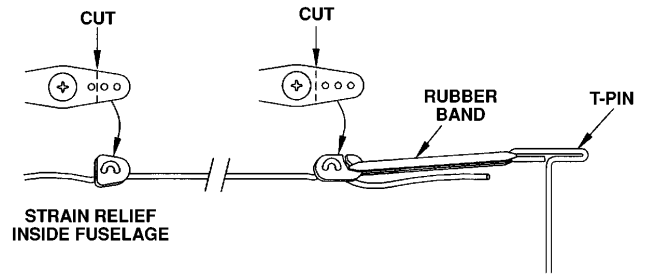

10. Extend the receiver antenna and route it through the fuselage. Connect the end of the antenna to the tip of the fin or stab with a T-pin and a rubber band or other hardware suitable for that purpose. You can make a hook from a cut off servo arm.

11. Make all the necessary radio system connections (servo, switch and battery), to operate the radio.

GET THE MODEL READY TO FLY

Check the Control Directions

1. Turn on the transmitter and receiver and center the trims. If necessary, remove the servo arms from the servos and reposition them so they are centered. Reinstall the servo arm screws.

2. With the transmitter and receiver still on, check all the control surfaces to see if they are centered. If necessary, adjust the clevises on the pushrods to center the control surfaces.

3. Make certain that the control surfaces and the carburetor respond in the correct direction as shown in the diagram. If any of the controls respond in the wrong direction, use the servo reversing switches in the transmitter to reverse the servos connected to those controls. Be certain the control surfaces have remained centered. Adjust if necessary.

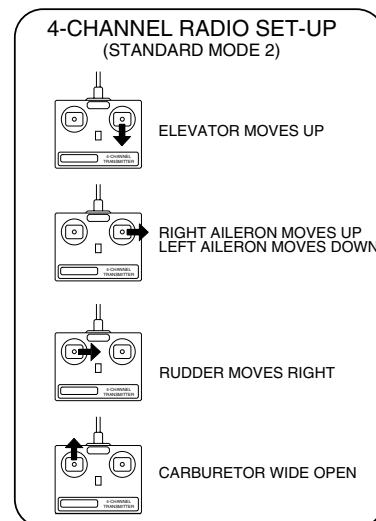

Set the Control Throws



Use a Great Planes AccuThrow (or a ruler) to accurately measure and set the control throw of each control surface as indicated in the chart that follows. If your radio does not have dual rates, we recommend setting the throws at the high rate settings.

Note: The throws are measured at the **widest part** of the elevators, rudder and ailerons.

These are the recommend control surface throws:

	High Rate	Low Rate
ELEVATOR:	1-1/2" [38mm] up 1-1/2" [38mm] down	3/4" [19mm] up 3/4" [19mm] down
RUDDER:	1-1/2" [38mm] right 1-1/2" [38mm] left	1" [25mm] right 1" [25mm] left
AILERONS:	1" [25mm] up 1" [25mm] down	3/4" [19mm] up 3/4" [19mm] down

IMPORTANT: The Pete 'n Poke has been **extensively** flown and tested to arrive at the throws at which it flies best. Flying your model at these throws will provide you with the greatest chance for successful first flights. If, after you have become accustomed to the way the Pete 'n Poke flies, you would like to change the throws to suit your taste, that is fine. However, too much control throw could make the model difficult to control, so remember, "more is not always better."

Balance the Model (C.G.)

More than any other factor, the **C.G.** (balance point) can have the **greatest** effect on how a model flies, and may determine whether or not your first flight will be successful. If you value this model and wish to enjoy it for many flights, **DO NOT OVERLOOK THIS IMPORTANT PROCEDURE.** A model that is not properly balanced will be unstable and possibly unflyable.

At this stage the model should be in ready-to-fly condition with all of the systems in place including the engine, propeller, spinner, landing gear, wheels, covering and paint, and the radio system.

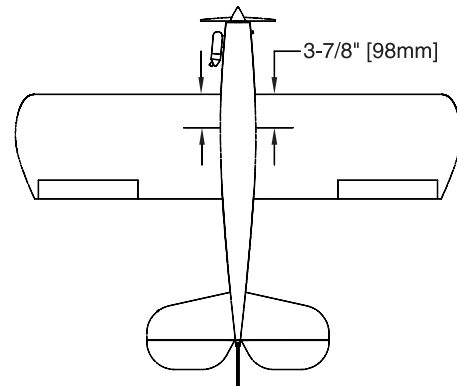

1. Use a felt-tip pen or 1/8"-wide tape to accurately mark the C.G. on the **bottom** of the wing on both sides of the main wing struts. The C.G. is located 3-7/8" [98mm] back from the leading edge of the wing.

This is where your model should balance for your first flights. Later, you may wish to experiment by shifting the C.G. up to 5/8" [16mm] forward or 5/8" [16mm] back to change the flying characteristics. Moving the C.G. forward may improve the smoothness and stability, but it may then require more speed for takeoff and make it more difficult to slow for landing. Moving the C.G. aft makes the model more maneuverable, but could also cause it to become difficult to control. In any case, start at the location we recommend and do not at any time balance your model outside the recommended range.

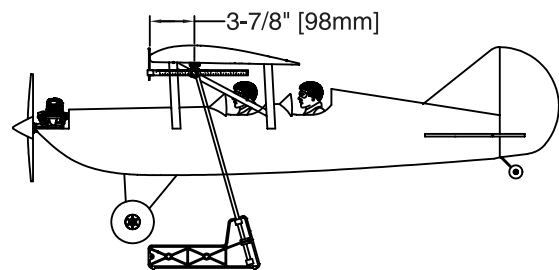

2. With the wing attached to the fuselage, all parts of the model installed (ready to fly) and an empty fuel tank, place the model on a Great Planes CG Machine, or lift it at the balance point you marked.

❑ 3. If the tail drops, the model is “tail heavy” and the battery pack and/or receiver must be shifted forward or weight must be added to the nose to balance. If the nose drops, the model is “nose heavy” and the battery pack and/or receiver must be shifted aft or weight must be added to the tail to balance. If possible, relocate the battery pack and receiver to minimize or eliminate any additional ballast required. If additional weight is required, nose weight may be easily added by using a “spinner weight” (GPMQ4645 for the 1 oz. weight, or GPMQ4646 for the 2 oz. weight). If spinner weight is not practical or is not enough, use Great Planes (GPMQ4485) “stick-on” lead. A good place to add stick-on nose weight is to the firewall. Begin by placing incrementally increasing amounts of weight on the fuse over the firewall until the model balances. Once you have determined the amount of weight required, it can be permanently attached. If required, tail weight may be added by cutting open the bottom of the fuse and gluing it permanently inside.

Note: Do not rely upon the adhesive on the back of the lead weight to permanently hold it in place. Over time, fuel and exhaust residue may soften the adhesive and cause the weight to fall off. Use #2 sheet metal screws, RTV silicone or epoxy to permanently hold the weight in place.

❑ 4. **IMPORTANT:** If you found it necessary to add any weight, recheck the C.G. after the weight has been installed.

Balance the Model Laterally

❑ 1. With the wing level, have an assistant help you lift the model by the engine propeller shaft and the bottom of the fuse under the TE of the fin. Do this several times.

❑ 2. If one wing always drops when you lift the model, it means that side is heavy. Balance the airplane by adding weight to the other wing tip. **An airplane that has been laterally balanced will track better in loops and other maneuvers.**

PREFLIGHT

Identify Your Model

No matter if you fly at an AMA sanctioned R/C club site or if you fly somewhere on your own, you should always have your name, address, telephone number and AMA number on or inside your model. It is **required** at all AMA R/C club flying sites and AMA sanctioned flying events. Fill out the identification tag on the page 41 and place it on or inside your model.

Charge the Batteries

Follow the battery charging instructions that came with your radio control system to charge the batteries. You should always charge your transmitter and receiver batteries the night before you go flying, and at other times as recommended by the radio manufacturer.

Note: Checking the condition of your receiver battery pack is **highly recommended**. All battery packs, whether it's a trusty pack you've just taken out of another model, or a new battery pack you just purchased, should be cycled, noting the discharge capacity. Oftentimes, a weak battery pack can be identified (and a valuable model saved!) by comparing its actual capacity to its rated capacity. Refer to the instructions and recommendations that come with your cycler. If you don't own a battery cycler, perhaps you can have a friend cycle your pack and note the capacity for you.

Balance the Propeller

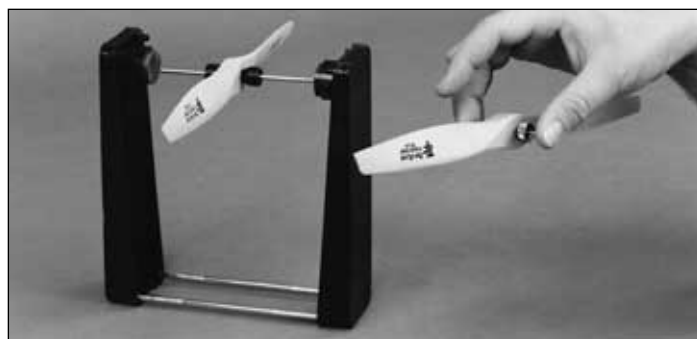

Carefully balance your propeller and spare propellers before you fly. An unbalanced prop can be the single most significant cause of vibration that can damage your model. Not only will engine mounting screws and bolts loosen, possibly with disastrous effect, but vibration may also damage your radio receiver and battery. Vibration can also cause your fuel to foam, which will, in turn, cause your engine to run hot or quit.

We use a Top Flite Precision Magnetic Prop Balancer™ (TOPQ5700) in the workshop and keep a Great Planes Fingertip Prop Balancer (GPMQ5000) in our flight box.

Ground Check

If the engine is new, follow the engine manufacturer's instructions to break-in the engine. After break-in, confirm that the engine idles reliably, transitions smoothly and rapidly to full power and maintains full power—indefinitely. After you run the engine on the model, inspect the model closely to make sure all screws remained tight, the hinges are secure, the prop is secure and all pushrods and connectors are secure.

Range Check

Ground check the operational range of your radio before the first flight of the day. With the transmitter antenna collapsed and the receiver and transmitter on, you should be able to walk at least 100 feet away from the model and still have control. Have an assistant stand by your model and, while you work the controls, tell you what the control surfaces are doing. Repeat this test **with the engine running** at various speeds with an assistant holding the model, using hand signals to show you what is happening. If the control surfaces do not respond correctly, **do not fly!** Find and correct the problem first. Look for loose servo connections or broken wires, corroded wires on old servo connectors, poor solder joints in your battery pack or a defective cell, or a damaged receiver crystal from a previous crash.

ENGINE SAFETY PRECAUTIONS

Failure to follow these safety precautions may result in severe injury to yourself and others.

Keep all engine fuel in a safe place, away from high heat, sparks or flames, as fuel is very flammable. Do not smoke near the engine or fuel; and remember that engine exhaust gives off a great deal of deadly carbon monoxide. Therefore **do not run the engine in a closed room or garage.**

Get help from an experienced pilot when learning to operate engines.

Use safety glasses when starting or running engines.

Do not run the engine in an area of loose gravel or sand; the propeller may throw such material in your face or eyes.

Keep your face and body as well as all spectators away from the plane of rotation of the propeller as you start and run the engine.

Keep these items away from the prop: loose clothing, shirt sleeves, ties, scarfs, long hair or loose objects such as pencils or screwdrivers that may fall out of shirt or jacket pockets into the prop.

Use a "chicken stick" or electric starter to start the engine. Do not use your fingers to flip the propeller. Make certain the glow plug clip or connector is secure so that it will not pop off or otherwise get into the running propeller.

Make all engine adjustments from behind the rotating propeller.

The engine gets hot! Do not touch it during or right after operation. Make sure fuel lines are in good condition so fuel will not leak onto a hot engine, causing a fire.

To stop a glow engine, cut off the fuel supply by closing off the fuel line or following the engine manufacturer's recommendations. Do not use hands, fingers or any other body part to try to stop the engine. To stop a gasoline powered engine, an on/off switch should be connected to the engine coil. Do not throw anything into the propeller of a running engine.

AMA SAFETY CODE (excerpt)

Read and abide by the following Academy of Model Aeronautics Official Safety Code:

GENERAL

1. I will not fly my model aircraft in sanctioned events, air shows, or model flying demonstrations until it has been proven to be airworthy by having been previously successfully flight tested.

2. I will not fly my model aircraft higher than approximately 400 feet within 3 miles of an airport without notifying the airport operator. I will give right of way to, and avoid flying in the proximity of, full-scale aircraft. Where necessary an observer shall be used to supervise flying to avoid having models fly in the proximity of full-scale aircraft.

3. Where established, I will abide by the safety rules for the flying site I use, and I will not willfully and deliberately fly my models in a careless, reckless and/or dangerous manner.

7. I will not fly my model unless it is identified with my name and address or AMA number, on or in the model.

9. I will not operate models with pyrotechnics (any device that explodes, burns, or propels a projectile of any kind).

RADIO CONTROL

1. I will have completed a successful radio equipment ground check before the first flight of a new or repaired model.

2. I will not fly my model aircraft in the presence of spectators until I become a qualified flier, unless assisted by an experienced helper.

3. I will perform my initial turn after takeoff away from the pit or spectator areas, and I will not thereafter fly over pit or spectator areas, unless beyond my control.

4. I will operate my model using only radio control frequencies currently allowed by the Federal Communications Commission.

CHECK LIST

During the last few moments of preparation your mind may be elsewhere, anticipating the excitement of your first flight. Because of this, you may be more likely to overlook certain checks and procedures that should be performed after your model is built. To help avoid this, we've provided a checklist to make sure you don't overlook these important areas. Many are covered in the instruction manual, so where appropriate, refer to the manual for complete instructions. Be sure to check the items off as you complete them (that's why we call it a *check list!*)

1. Fuelproof all areas exposed to fuel or exhaust residue such as the engine mount area, the landing gear mounts, the inside of the hatches, etc.
2. Check the C.G. according to the measurements provided in the manual.
3. Be certain the battery and receiver are securely mounted in the fuse. Simply stuffing them into place with foam rubber is not sufficient.
4. Extend your receiver antenna and make sure it has a strain relief inside the fuselage to keep tension off the solder joint inside the receiver.
5. Balance your model *laterally* as explained in the instructions.
6. Use thread locking compound to secure critical fasteners such as the set screws that hold on the wheels, screws that hold the carburetor arm (if applicable), screw-lock pushrod connectors, etc.
7. Add a drop of oil to the axles so the wheels will turn freely.
8. Make sure all hinges are **securely** glued in place.
9. Reinforce holes for wood screws with thin CA where appropriate (servo mounting screws, cowl mounting screws, etc.).
10. Confirm that all controls operate in the correct direction and the throws are set up according to the manual.
11. Make sure there are silicone retainers on all the clevises and that all servo arms are secured to the servos with the screws included with your radio.
12. Secure connections between servo wires and Y-connectors or servo extensions, and the connection between your battery pack and the on/off switch with vinyl tape, heat shrink tubing or special clips suitable for that purpose.
13. Make sure any servo extension cords you may have used do not interfere with other systems (servo arms, pushrods, etc.).
14. Make sure the fuel lines are connected and are not kinked.
15. Use an incidence meter to check the wing for twists and attempt to correct before flying.
16. Balance your propeller (and spare propellers).
17. Tighten the propeller nut and spinner.
18. Place your name, address, AMA number and telephone number on or inside your model.
19. Cycle your receiver battery pack (if necessary) and make sure it is fully charged.
20. If you wish to photograph your model, do so before your first flight.
21. Range check your radio when you get to the flying field.

FLYING

The Pete 'n Poke Sport 40 is a great-flying model that flies smoothly and predictably. The Pete 'n Poke does not, however, pose the self-recovery characteristics of a primary R/C trainer and should be flown only by R/C pilots who have already learned how to fly a trainer.

CAUTION (THIS APPLIES TO ALL R/C AIRPLANES): If, while flying, you notice any unusual sounds, such as a low-pitched "buzz," this may indicate control surface *flutter*. Because flutter can quickly destroy components of your airplane, any time you detect flutter you must **immediately** cut the throttle and land the airplane! Check all servo grommets for deterioration (this may indicate which surface fluttered), and make sure all pushrod linkages are secure and free of play. If the control surface fluttered once, it probably will flutter again under similar circumstances unless you can eliminate the free-play or flexing in the linkages. Here are some things which can cause flutter: Excessive hinge gap; Not mounting control horns solidly; Poor fit of clevis pin in horn; Side-play of pushrod in guide tube caused by tight bends; Poor fit of Z-bend in servo arm; Insufficient glue used when gluing in the elevator joiner wire; Excessive *play* or *backlash* in servo gears; and Insecure servo mounting.

Takeoff

Before you get ready to takeoff, see how the model handles on the ground by doing a few practice runs at **low speeds** on the runway. Hold "up" elevator to keep the tail wheel on the ground. If necessary, use pliers to bend the tail gear wire so the model will roll straight down the runway when the rudder is centered. If you need to calm your nerves before the maiden flight, shut the engine down and bring the model back into the pits. Top off the fuel, then check all fasteners and control linkages for peace of mind.

Remember to takeoff into the wind. Due to its high wing, the Pete 'n Poke is affected by crosswinds more than other models. Make all attempts to takeoff directly into the wind until you get a better feel for how the model behaves in crosswinds. When you're ready to takeoff, point the model straight down the runway. Hold a bit of up elevator to keep the tail on the ground to maintain tail wheel steering, then gradually advance the throttle. As the model gains speed, decrease up elevator, allowing the tail to come off the ground. One of the most important things to remember with a tail dragger is to always be ready to apply **right** rudder to counteract engine torque. Gain as much speed as your runway will allow before gently applying up elevator, lifting the model into the air. At this moment it is likely that you will need to apply more right rudder to counteract engine torque. Be smooth on the elevator stick, allowing the model to establish a **gentle** climb to a safe altitude before turning into the traffic pattern.

Flight

For reassurance and to keep an eye on other traffic, it is a good idea to have an assistant on the flight line with you. Tell him to remind you to throttle back once the plane gets to a comfortable altitude. While full throttle may be desirable for takeoff, the Pete 'n Poke flies best near half-throttle settings.

Take it easy with the Pete 'n Poke for the first few flights, gradually getting acquainted with it as you gain confidence. Adjust the trims to maintain straight and level flight. After flying around for a while, and while still at a safe altitude with plenty of fuel, practice slow flight and execute practice landing approaches by reducing the throttle to see how the model handles at slower speeds. Add power to see how she climbs as well. Continue to fly around, executing various maneuvers and making mental notes (or having your assistant write them down) of what trim or C.G. changes may be required to fine tune the model so it flies the way you like. Mind your fuel level, but use this first flight to become familiar with your model before landing.

Landing

To initiate a landing approach, lower the throttle while on the downwind leg. Allow the nose of the model to pitch downward to gradually bleed off altitude. Continue to lose altitude, but maintain airspeed by keeping the nose down as you turn onto the crosswind leg. Make your final turn toward the runway (into the wind) keeping the nose down to maintain airspeed and control. Level the attitude when the model reaches the runway threshold, modulating the throttle as necessary to maintain your glide path and airspeed. If you are going to overshoot, smoothly advance the throttle (always ready on the right rudder to counteract torque) and climb out to make another attempt. When you're ready to make your landing flare and the model is a foot or so off the deck, smoothly increase up elevator until it gently touches down. Once the model is on the runway and has lost flying speed, hold up elevator to place the tail on the ground, regaining tail wheel control.

One final note about flying your model. Have a goal or flight plan in mind for **every** flight. This can be learning a new maneuver, improving a maneuver you already know, or learning how the model behaves in certain conditions (such as on high or low rates). This is not necessarily to improve your skills (*though it is never a bad idea!*), but more importantly so you do not surprise yourself by impulsively attempting a maneuver and suddenly finding that you've run out of time, altitude or airspeed. Every maneuver should be deliberate, not impulsive. For example, if you're going to do a loop, check your altitude, mind the wind direction (anticipating rudder corrections that will be required to

maintain heading), remember to throttle back at the top, and make certain you are on the desired rates (high/low rates). A flight plan greatly reduces the chances of crashing your model just because of poor planning and impulsive moves. **Remember to think!**

Have a ball! But always stay in control and fly in a safe manner.

GOOD LUCK AND GREAT FLYING!

This model belongs to:

Name

Address

City, State Zip

Phone number

AMA number

Fill out the tag and place it inside your model.

OTHER ITEMS AVAILABLE FROM GREAT PLANES



Great Planes SlowPoke™

Wing Area: 656.5 sq in
Weight: 2.5–3.5 lb
Fuselage Length: 36.5 in

The 50" span SlowPoke draws attention from onlookers, but demands less time, money and effort from the builder. Its compact size makes it ideal for small, low-cost engines, and easier to transport for small-field flying. CAD engineering

and lightweight, interlocking wood parts shorten frame-up to just one weekend. Requires a 4-channel radio with 3 servos, a 2-stroke .10-.25 or 4-stroke .26 engine and 2 rolls of MonoKote®. **GPMA0491**



Great Planes SlowPoke™ Sport 40

Wing Area: 1076 sq in
Weight: 6-6.5 lb
Fuselage Length: 49 in

Its vintage looks guarantee flight line compliments—while the low price, quick assembly and easy performance will please any pilot who wants to kick back and enjoy. The 61.5" span SlowPoke Sport 40 features interlocking wood parts that shorten frame-up to one weekend, plus a flat-bottom airfoil and huge wing area for outstanding lifting power! Requires a 4-channel radio with 5 servos, a 2-stroke .32-.46 or 4-stroke .40-.52 engine and 3 rolls of MonoKote®. **GPMA0492**



Great Planes AccuPoint™ Laser Incidence Meter

Measure incidence with one-quarter degree accuracy and amazing ease! Clamped to a wing, AccuPoint's bearing-supported laser sends a thin beam of ruby light to illuminate readings on the extra-large scale. Great for determining wing or stab incidence and wing washout, and also includes an accessory that readies it for measuring engine thrust angle. Works on wings of up to 16" chord—and comes with a battery for the laser and a 1-year warranty on parts and labor. **GPMR4020**



Great Planes C.G. Precision Aircraft Balancer™

Accurate balancing makes trainers more stable, low-wings more agile, and pylon planes move at maximum speed. The innovative C.G. Machine helps you achieve optimum balance easily, without measuring or marking—and without the errors that fingertip balancing can cause. You'll quickly pinpoint your plane's exact center of gravity. Then you'll know at a glance whether weight should be added, removed or relocated. The C.G. Machine works with kits and ARF models of any size and wingspan. Its slanted wire balancing posts support models weighing up to 40 pounds. **GPMR2400**



Great Planes Slot Machine™ Motorized Hinge Slotting Tool

You probably dread cutting hinge slots...for one project, the job can take over an hour! With the electric-powered Slot Machine, you'll safely and easily cut all of your kit's hinge slots in only about 10 minutes. The sawing action of its two blades cuts through wood—even hard spots—without gouging or compressing it like knife blades do. The result is a clean, consistent slot with room for CA to wick all around and form a dependable bond. The Slot Machine comes fully assembled with two pre-installed, replaceable blades and a rugged plastic body. U.S. Pat. 6,096,357. **GPMR4010**

TWO VIEW DRAWING
Use copies of this page to plan your trim scheme

