

Wing span [mm]:	2500
Wing area [dm <sup>2</sup> ]:	44
Aspect ratio:	14
Take-off weight [g]:	from 1500-2200g
Wing loading:	34-50g/dm <sup>2</sup>
Airfoil:	VS2/ VS3/ VS4/ VS5/ VS6 Modern F3b-F3f airfoils

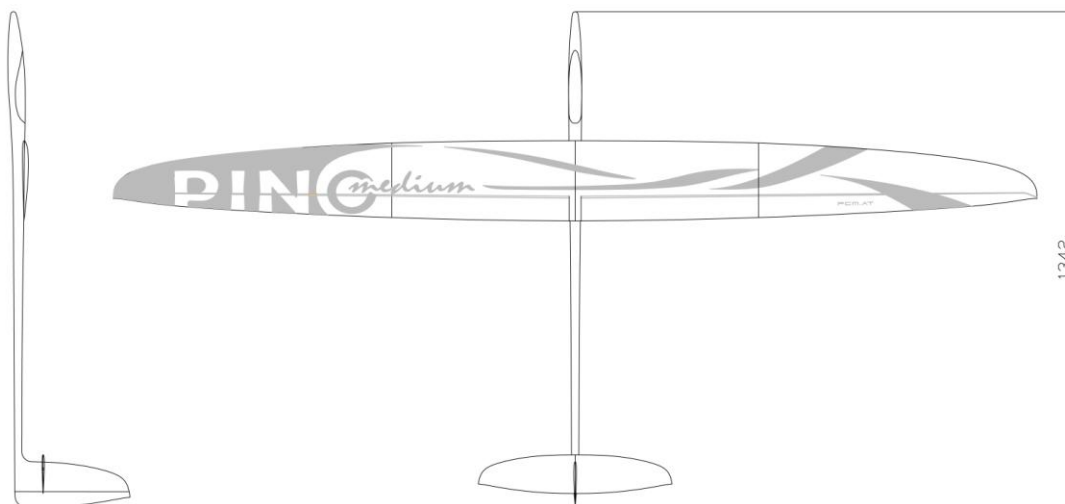
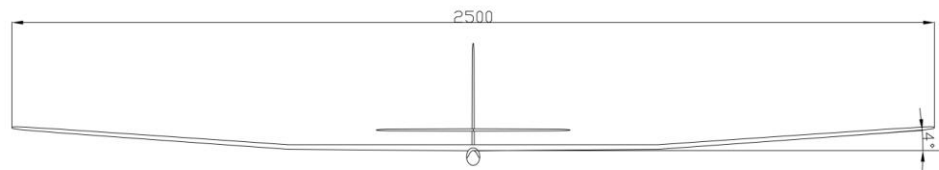

## BUILDING INSTRUCTION

Allround fun glider PINO – electric version

## CONTENTS

### DATA

1. Kit – contents	3
2. What else do you need?	3
3. Electronic equipment	3

### ASSEMBLING THE MODEL

4. Wing	4
4.1 Controlling flaps and ailerons	4
5. Fuselage	8
5.1 Servoboard	8
5.2 Electric drive	11
5.3 Contacts for flaps and ailerons	12
5.4 Connection of rudder	13
5.5 Canopy	13
5.6 Hook for winchstart	13
6. Ballast	14
7. Settings for the first flight	15

### OTHER

8. Check list before starting	18
9. Notes for use	18

**DATA**

**1. Kit – contents**

- Fuselage + canopy
- Wing
- Elevator
  
- Lever for controlling rudder, 1 pc.
- Lever for controlling ailerons, 2 pc.
- Lever for controlling flaps, 2 pc.
- Steel wire 1,2mm for rudder, 1 pc.
- M2,5 screw rod for controlling ailerons, 4 pc.
- 8x lever connectors M2,5
- 1x lever connectors M2
- M4 metal screws for fixing wing, 4 pc.
- M4 nylon screws for fixing wing, 4 pc.
- Spring-loaded contacts 2 pairs.

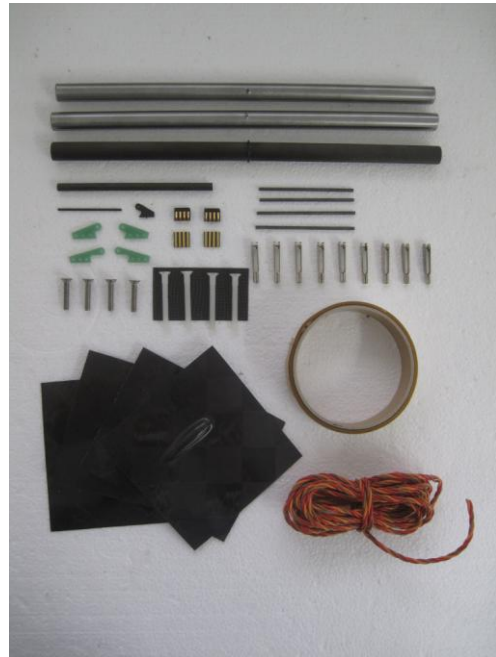

Building instruction (for download from our website)

Connectors / ballast:

	Segler / Glider	Elektro
<b>Normal (Slope)</b>		
<b>Medium</b>	1x Kohlestab / <i>carbon rod</i> 1x Stahl lang / <i>steel long</i> 2x Stahl kurz / <i>steel short</i>	1x Kohlestab / <i>carbon rod</i> 1x Stahl lang / <i>steel long</i> 2x Stahl kurz / <i>steel short</i>
<b>Ultralight</b>		

**2. What else do you need:**

- Epoxy-glue (for example UHU 300 endfest or Pattex Stabilith)
- Super glue (runny)
- Electrical equipment (On/Off-switch, cables, plug...)
- Electronic equipment
- Shrinking tube...

**3. Electronic equipment (recommendation)**

- Servo ailerons and flaps: - KST DS 135 MG
  - Servo rudder and elevator: - KST X08
  - Receiver: - for 4 wing servos, rudder and elevator servos
  - Motor: - Schambeck Powerline 1025
  - Controller: - YGE60LVS
  - Prop: - RFM 16 x 8,5 narrow
  - Spinner: - D=28mm
  - Accumulators: - Lipo 3S from 850-1000mA/h
- Following cells fit well into the fuselage:
- Wellpower SE CH8 850mA/h, 3S, 71g, 75/25/20
  - Wellpower SE „sonder“ 950mA/h, 3S, 70g, 75/25/19
  - Wellpower SE V2 CH8 1000mA/h, 3S, 93g, 64/32/23
- Source: Modellbau Lindinger

## 4. WING



### 4.1 Controlling flaps and ailerons

#### Fixing the servos

First of all, prepare the **surfaces** which will be glued. **Grind** them with a rough paper (about 80-40 grain size).

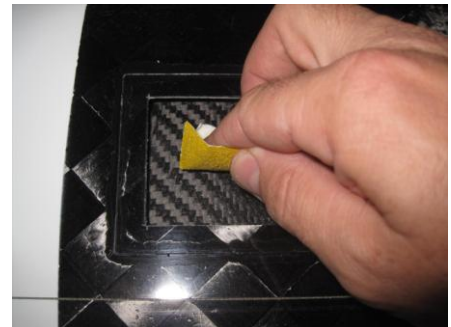

Then, set the servo to the **zero position** and **screw it to the frame**. The screwing is important, because if you screw the servo after gluing it into the wing, tension will occur and the surface of the wing will get wavy.

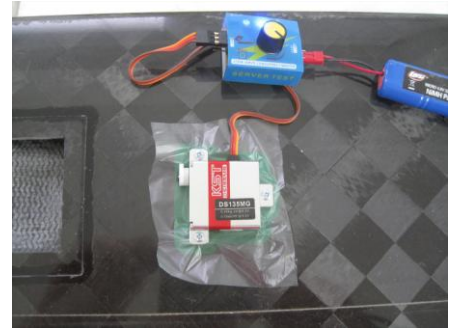

The **lever lengths:**

**Aileron: 8mm** (first hole of the smaller lever of the KST servos.)

**Flaps: 10mm** (first hole of the stronger lever of the KST servos.)

The length is measured from rotation center to hole center.



**Flap servo:**

Set the **servo** to its **zero position** and let the **lever** show a little bit **to the front**. So you get more break deflection.

**Aileron servo:**

Let the lever in **rectangular** position.

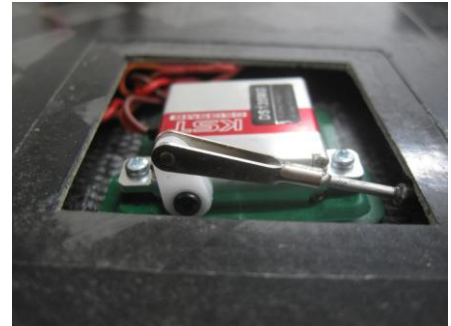

Verify the **free movement** of all the parts.



It will be necessary, that you **optimize the lever connector** as shown in the pictures besides.

It has to be done in different ways for the flaps and for the ailerons.



**Aileron servo**



**Flap servo**

Prepare the parts for gluing the control levers into the wing. **Grind all gluing surfaces**, the slot of the control surfaces and the levers themselves.



The **bolt** of the **lever connector** has sharp edges that are bigger than the bolt diameter. You should **remove these edges**, before you put the connector into the lever. It is easy to clean that bolt with nose pliers. Grab the bolt with the nose pliers and move the connector up and down about 3 times as shown in the picture. Repeat this that often until the connector is able to **move in the lever hole without a lot of friction**.

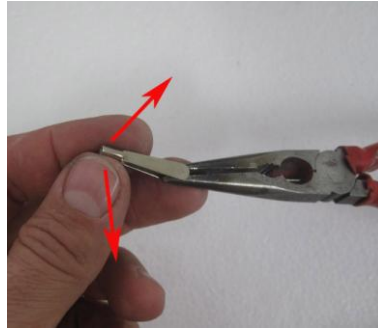

Before you glue the lever into the control surface, **fix the connector to the lever**.

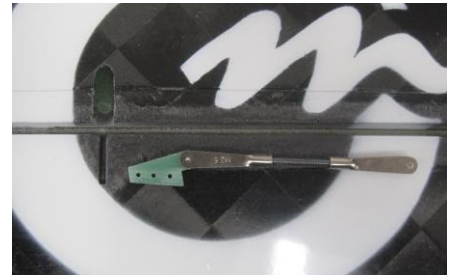

You can use **runny super glue** to fix the levers. This kind of bonding will be strong enough for the forces occurring.



**Cable mounting:**  
**Mill a hole** into the preformed space for the contacts. Make the hole big enough, so that the **contacts will not touch the carbon**.





Now, **slide the cables through** the hole.

Then **solder** the cable to the contacts.

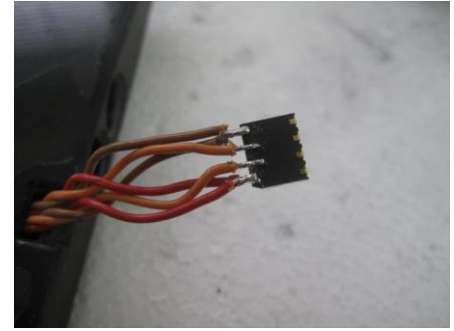

It is very important to **insulate all the contacts** that could touch the carbon. We use "Plasti Dip" for such purposes.

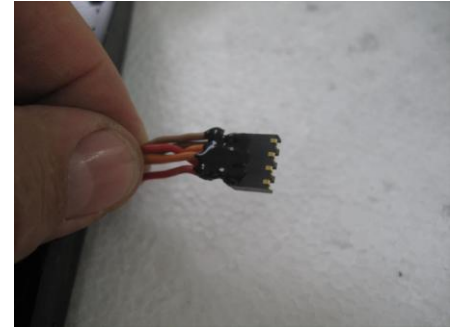

Make sure that the contact **fits easily** into the free space, which is provided for the contact, without putting any force on the soldered areas.



Before you fix the contact with a drop of runny super glue, check if **all the servos work well**.

**Anyone who is afraid that this work can not be carried out adequately, should use usual plug connections. If the spring contacts are installed incorrectly, the model may be totally lost.**

Now you can stick the **seals over the gaps**.



## 5. FUSELAGE – electric version

### 5.1 Servoboard

All necessary **holes** are already **pre-milled**.



CNC milled **wood parts** are included in the kit for mounting the **KST X08 V3**.

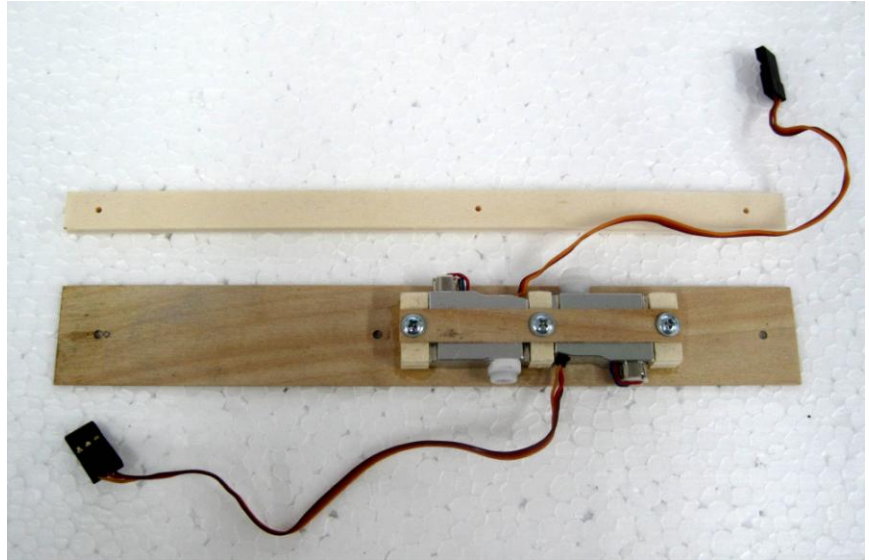

Set the parts together with **toothpicks**.

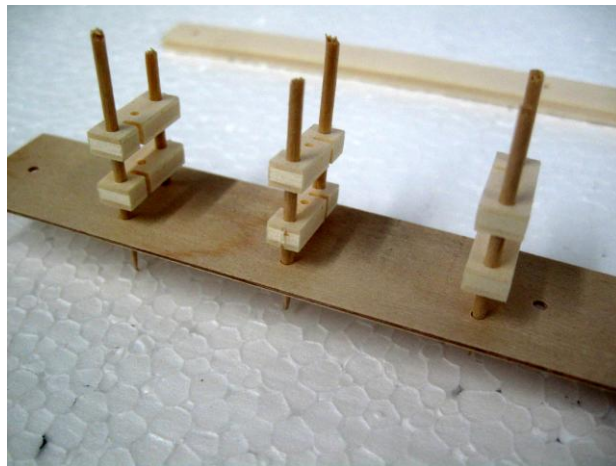



**Glue** everything with **super glue** and then cut off the toothpicks.

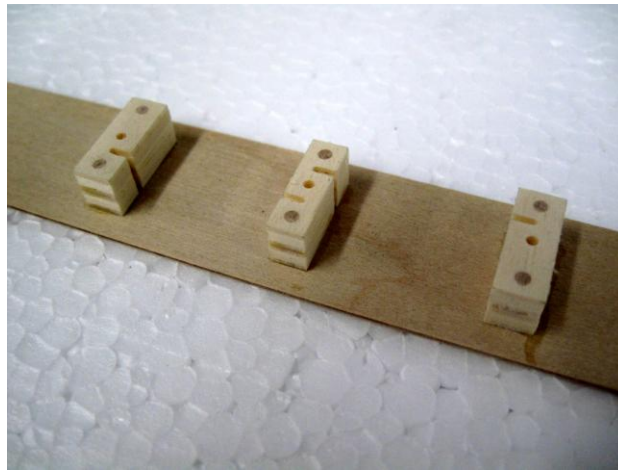

**Mount the servos** as shown in the picture.

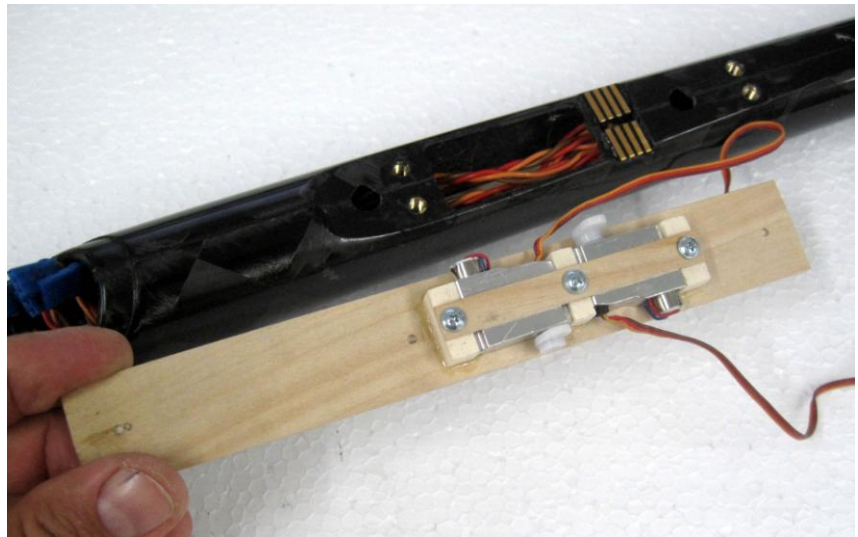

The **lever lengths** are:

**Elevator: 10mm** (big KST servo lever 2<sup>nd</sup> hole)

**Rudder: 8mm** (cross shaped KST servo lever 2<sup>nd</sup> hole)

Use the KST levers which are **nearer to the servo**. So you gain more space.

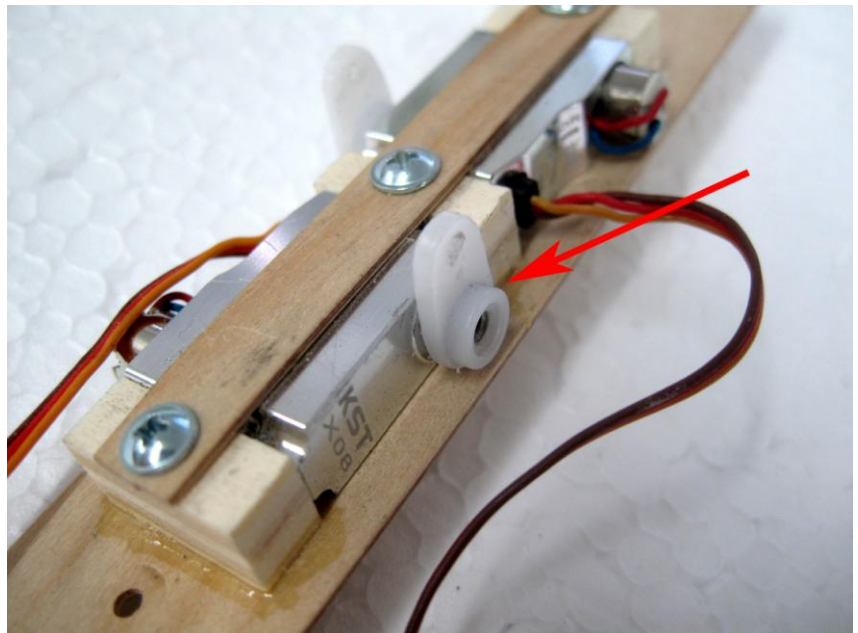

Now screw the **narrow board to the bottom** of the servoboard.

In order to glue it into the fuselage, put a mixture of **epoxy-cottonflocs just onto this narrow board**.

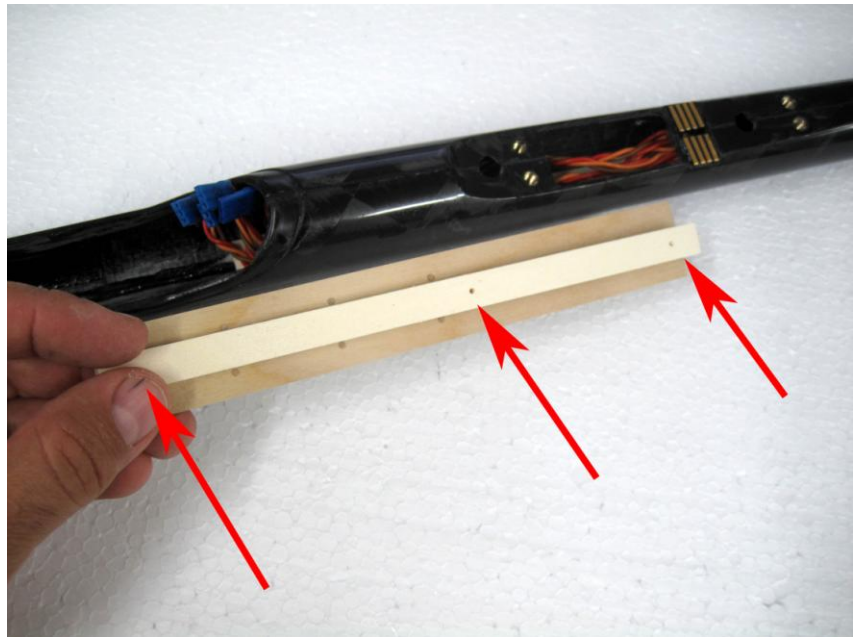

Then put the **servoboard into the fuselage**. **Connect the horns** to the pushrods and set everything to **zero** (servos and control surfaces). Then press the board down to **glue it well** to the bottom.

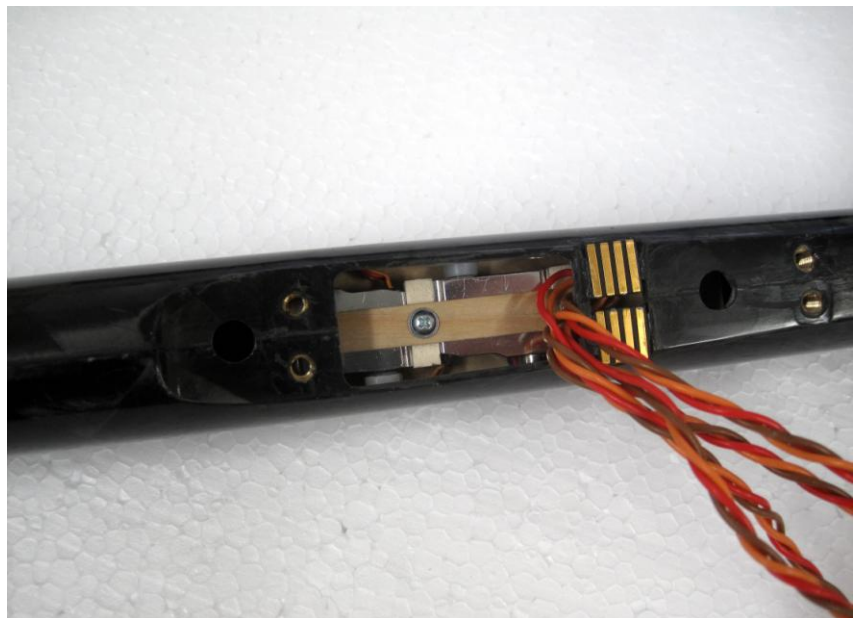

**Zero position of the elevator is 77mm.**

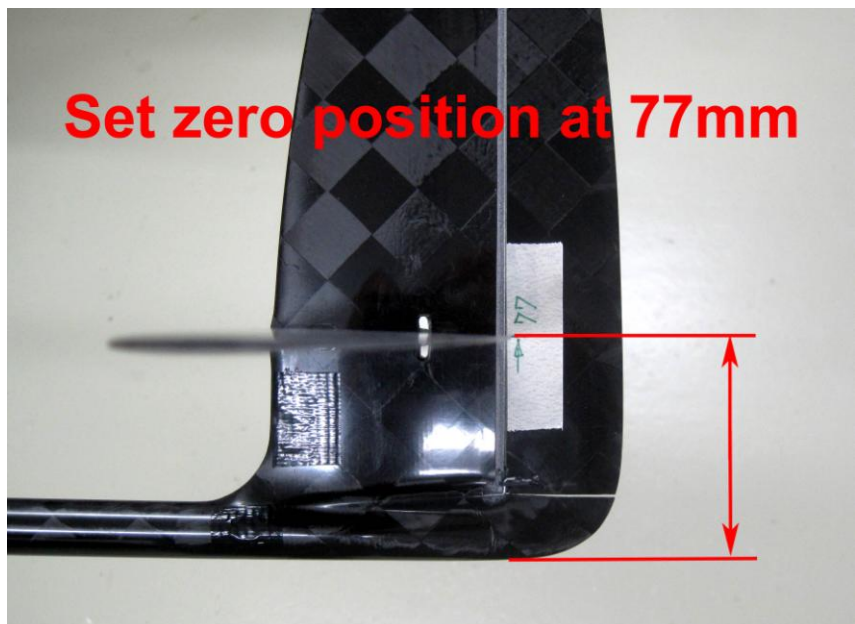

If you want to change the servos sometime, you can **loosen the screws through the holes in the fuselage.**

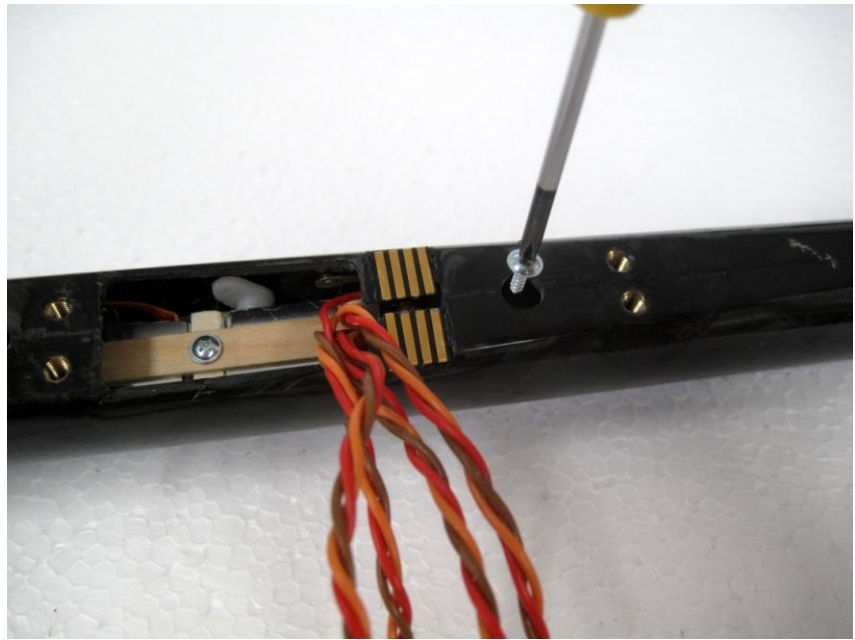

## 5.2 Electric drive

Now **glue the motor mounting** into the fuselage.

Grind a **45° angle** to the edges of the motor mounting and put it **1mm deeper into the fuselage** to get a bigger gluing area.



At the moment we recommend the **Powerline Pro Set** from Schambeck.





Here you see:  
If everything is installed, **enough space** is left to add a GPS, a vario, a logger or even a much bigger Lipo.

**Lipos from 850-1400mA/h** fit into the fuselage.

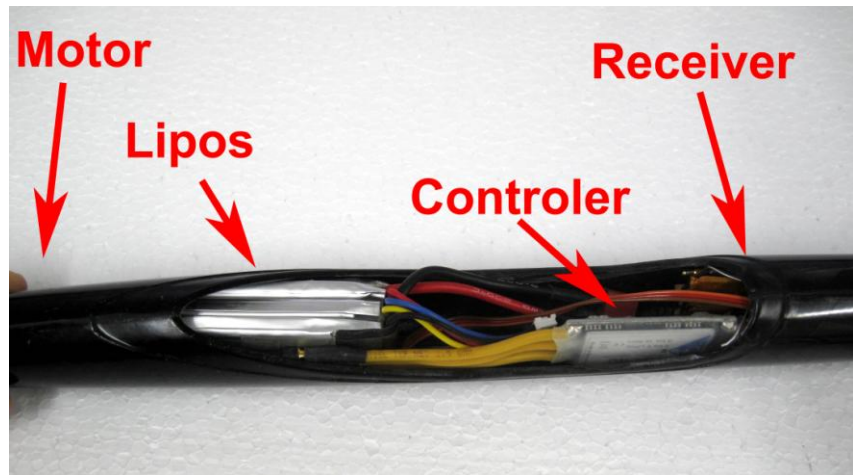

### 5.3 Contacts for flaps and ailerons

Next, let's finish the **aileron and flap contacts** for the fuselage.

The **cable length** should be about **32cm**. Pay attention that you solder the contacts in the same way as they are soldered in the wings.

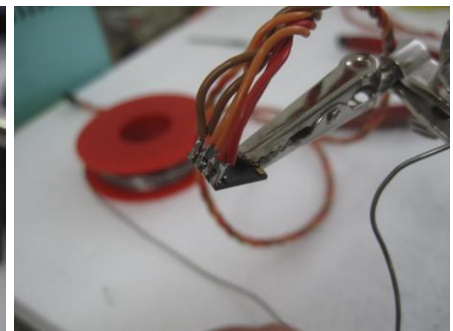
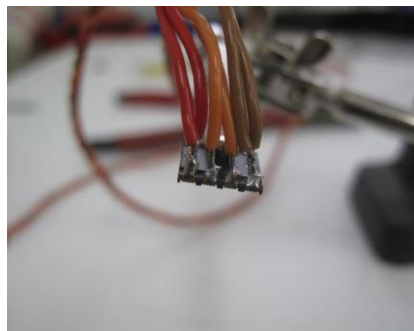

Then put a little bit **5 minute epoxy with cotton flocks** around the contacts. So you **insulate** and **strengthen** the soldered parts.



The rest of the contacts have to be **insulated extra**.

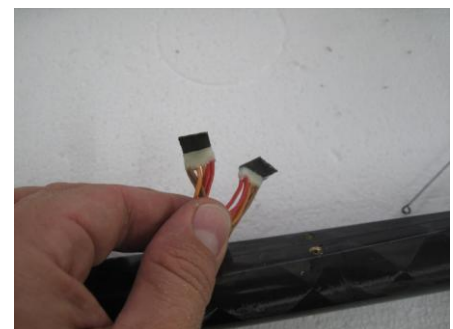

Before you fix the contacts to the fuselage with a runny super glue, make a **test, if everything is contacted well.**



#### 5.4 Connection of rudder

Fix the **lever in the control surface** and connect it to the **steel pushrod**.

Make a **mark for the zero position of the elevator** on the rudder.



#### 5.5 Canopy

We use a very simple solution to mount the canopy. Just **glue the carbon stick** into the canopy. Note that the gluing spot is only **in the middle** of stick and canopy, so you can thread the stick into the fuselage while the canopy remains on the outer side.

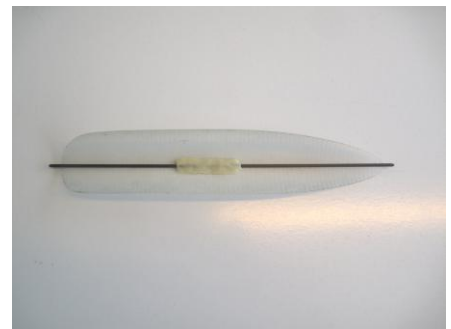

#### 5.6 Hook for winchstart

There is a **plywood part in the skin of the fuselage**, so that you can drill holes into the fuselage to position your hook. We recommend to start with a position of about **2cm in front of the CG**.





## 6. BALLAST

In the kit included are:

- 1x carbon rod
- 1x steel rod
- 2x short steel rods



You can use these rods as follows:

- **1x carbon rod** for **weak conditions** in the front hole. Adjust the CG of the plane with this rod inside.

**To optimize the center of gravity we have removed this front opening.**

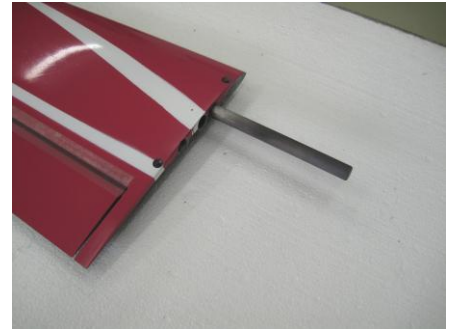

- **1x carbon + 1x steel rod** for **stronger conditions**

**To optimize the center of gravity we have removed the foremost opening.**

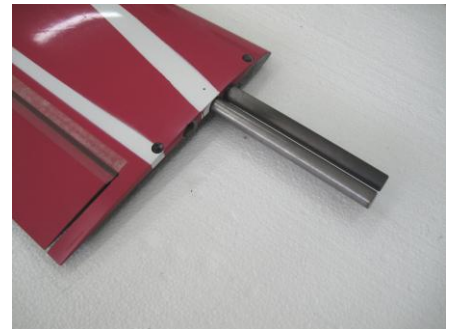

**1x carbon, 1x steel rod + 2x short steel** for **even stronger conditions.**

**To optimize the center of gravity we have removed the foremost opening.**

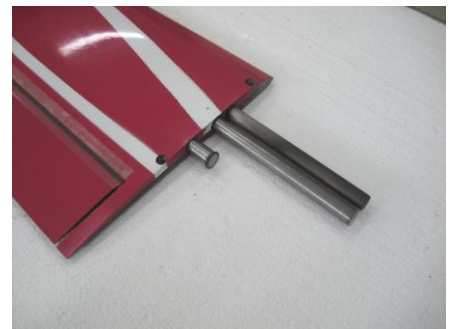

- **For extra strong conditions** you could put into a **40cm long steel rod** and two **20cm steel rods behind**. That ballast weights **700g**.  
When you fly with this setting, you have to take care that you **don't overload the wing structure**. So use the elevator softly, when you fly with that much ballast. Remember also that the landings have to be much softer with such an additional weight.



## 7. SETTINGS FOR FIRST FLIGHT

### Control adjustments PINO

14.07.2017

**CG: 91mm** (this CG is just for the electric version with prop RFM 16x8,5 narrow)

#### Maximum rudder deflection

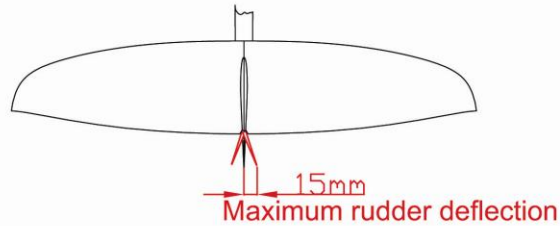

#### Maximum elevator deflection

(when you've got enough routine flying the plane you can increase the maximum elevator deflection)

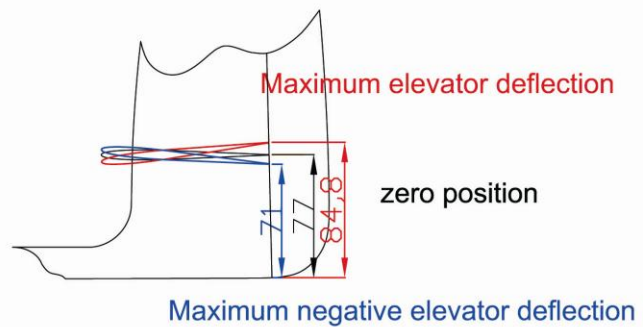

#### Maximum aileron deflection

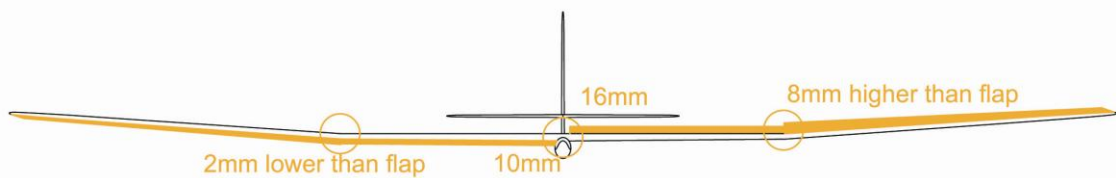

# Flap settings

28.10.2015

Thermaling position

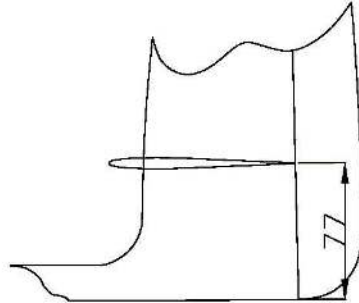

Elevator in zero position

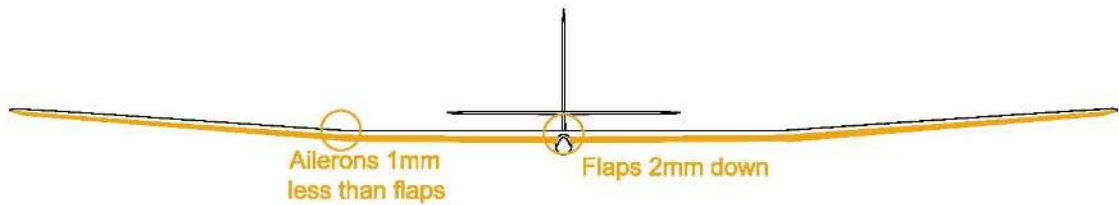

Speed setting

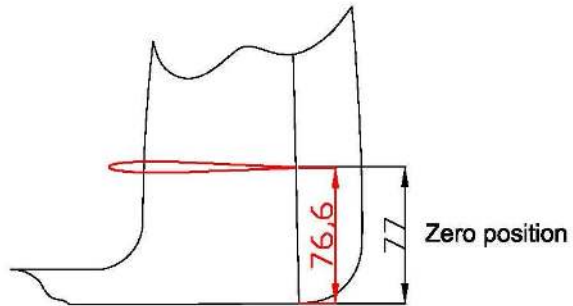

Elevator slightly pushed down

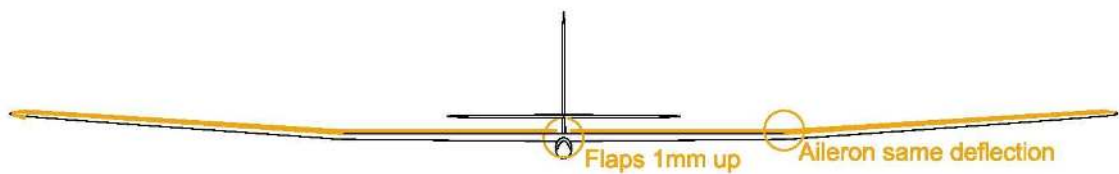

## "Butterfly" brake adjustment

14.07.2017

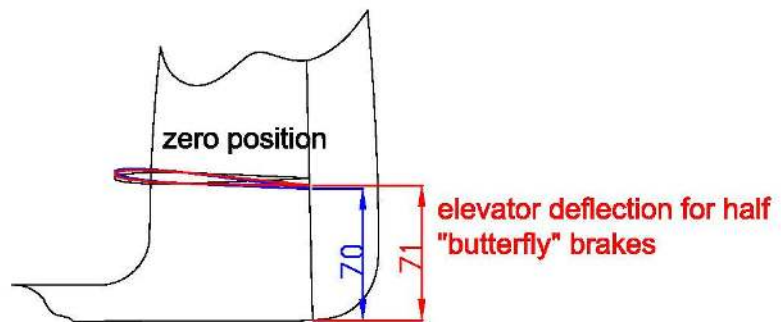

Elevator position for full "butterfly" brakes.

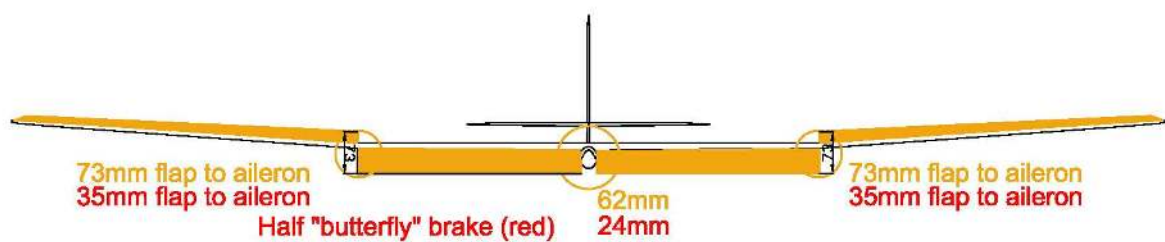

## OTHER

### 8. Check list before starting:

1. Check **centre of gravity**
2. Check **control surfaces**:
  - Do control surfaces move in the correct direction?
  - Check the greatest swings
3. Check **reception**
4. Check **control surfaces before each flight**.
  - Do all control surfaces still move correctly?
  - Is there enough power in the accumulator?
  - Are the brakes retracted?
  - You can save the retraction of the brakes in your start setting. By this, you can never start with extended brakes.
5. **Gentle launch** in the flat. If there are some wrong settings, you will realize it during a gentle throw in the flat.

### 9. Notes for the use

To avoid heating of the carbon surface, models with carbon wings should **not lie in the sun**.

**During flight** heating by the sun is no problem, as the model is **cooled by the wind**. **On ground** the glider should be kept **inside protective bags** or **in the shade**.

After every **ungentle landing**, you must **check your model for possible damage**, such as:

- Is the radio board still glued thoroughly?
- Did the leading edge of the wing burst open?
- Did rudder or elevator get damaged?