

**Configuration :**  PNP  FPV  RTF

Wingspan : 431mm

Length : 277mm

Material : EPP

Prop : 3.8\*3E

Battery : 7.4V 450mAh

Voltage : Only 2S

FC : FC01

ESC : 6A BLheli

Servo : WK-P0025(2.5g)\*2

Motor : XT1105\*5000KV

VTX : 200mW 48CH(FPV version)

Camera : RunCam micro swift 3(FPV version)

Transmitter : LDARC X6(RTF version)

Wing weight(no receiver & battery) :

PNP : 70g

FPV : 91g

RTF : 70g

Package weight :

PNP: 600g

FPV : 610g

RTF : 1150g

Package size :

PNP : 470\*290\*60mm

FPV : 470\*290\*60mm

RTF : 470\*290\*150mm



**Tools:**Screwdriver, foam glue, art knife and other tools

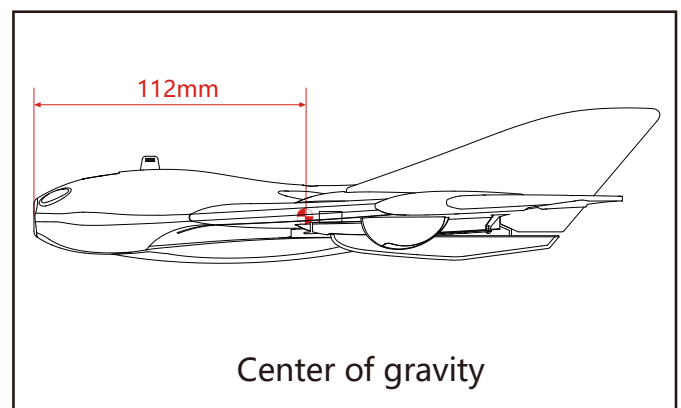
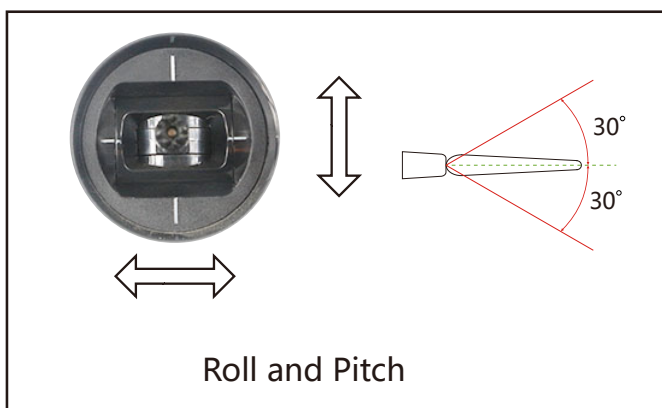

**Operate Step:** Open TX > Power on airplane > ESC & FC self test > ARM > Flying

Note: Be sure to open the transmitter first, then power on the plane; and be sure to the transmitter has been set up fail safe

## Pre-flight check:

Please switch to manual mode after the self-test is complete on the aircraft, at which point the left and right ailerons must be on the same horizontal surface as the wing root; if not inconsistent, it can be adjusted by the length of the steel rod.

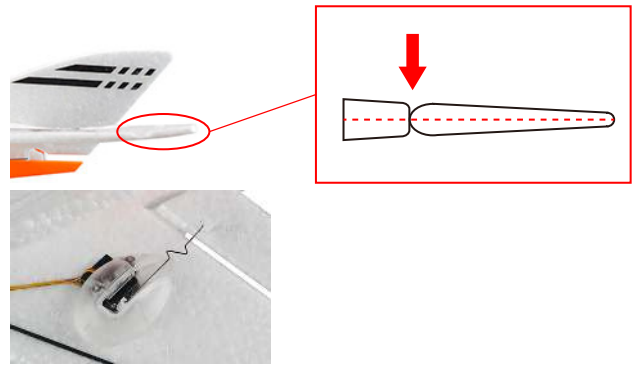

## FC

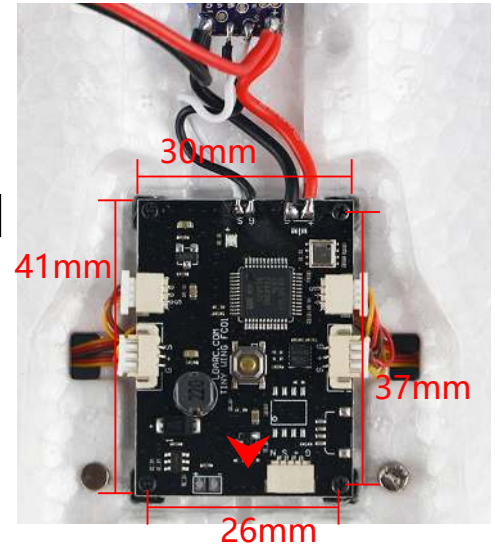
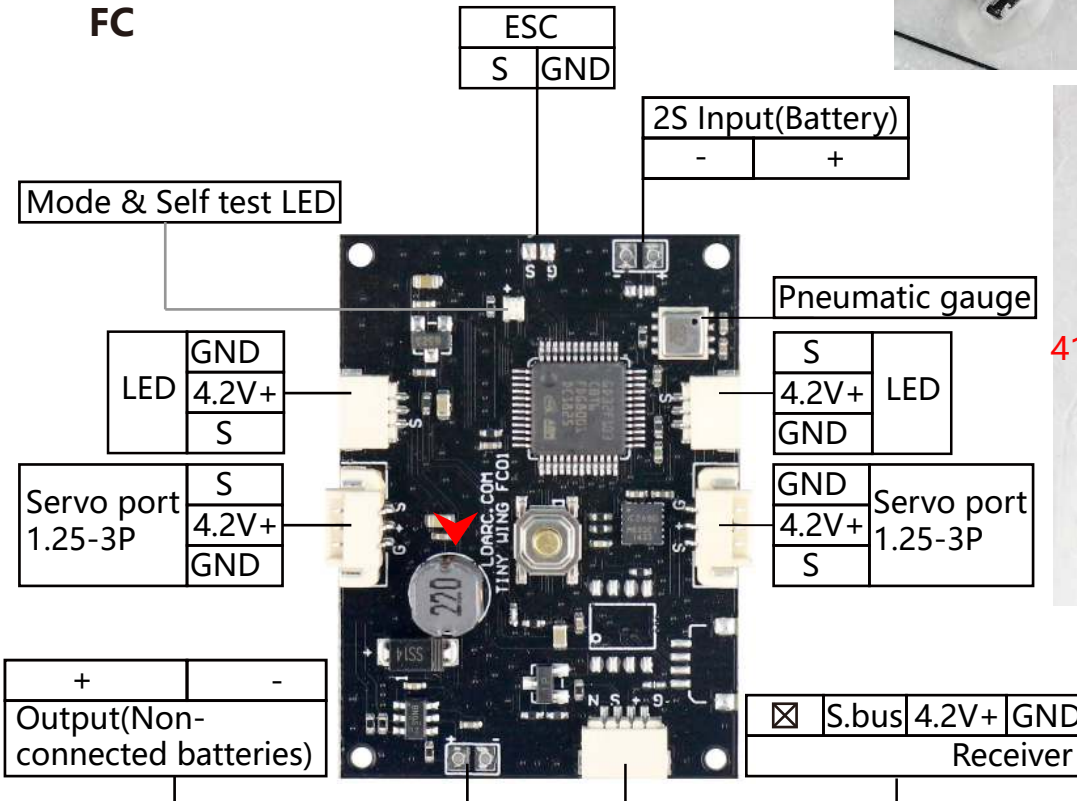

DIS-ARM/ARM	ARM	DIS-ARM
CH5	1700-2200	800-1699
LED	depends on (FLIGHT MODE)	RED keeps on

FLIGHT MODE	SELF LEVEL altitude hold on	MIX LEVEL altitude hold on	MANUAL MODE altitude shut down
CH6	1700-2200	1300-1699	800-1299
LED	GREEN keeps on	GREEN flashing	BLUE keeps on

To avoid airflow effects, stick a sponge above the barometer.

**Fail safe:** According to the TX and RX instructions setting fail safe, be sure that the motor stops when fail of TX.

**Receiver:** Use the S.BUS receiver, setting up fail safe and be sure that there is enough transmitter distance

**ESC self test:** Turn on the TX that is already bind, be sure 5CH is DIS-ARM, power on airplane and keep the airplane not moving, about 5S later, heard a long & short alarm sound means ESC finished self test

### Aircraft self-test:

Turn on the transmitter, which is already bind, and power on the plane, red LED fast flashing change to red bright, finish self test.

**Note:** Be sure to complete the plane's self-test before you fly, otherwise it is easy to crash.

**ARM mode:** CH5 (Dis-ARM, the LED always red; when ARM in self level mode, the LED always green; when ARM in mix level mode, the LED is green flashing; when ARM in manual mode, the LED always blue.

### Flight mode:

#### 1. Self level

- A: LED always green.
- B: Auto throw fly, according to the wind speed, push the throttle 70%~100% (pic1).
- C: Motor rotates, holding the plane horizontally thrown (pic2).
- D: Keep the set high flight when the plane climbs to a height of 20 meters, now finished auto throw fly.
- E: In the process of climbing, operate ailerons or lift, auto throw fly finished.
- F: Self level mode, control aircraft maximum tilt angle 40 degrees (pic3).

**Note:** Self level mode is not suitable for intense flight, if the speed changes too fast, the rod correction will be too high and the airplane will shaking.



- 2.Mix level(LED is green flashing,you can flip it 360 degrees; air pressure set high, current height hold)
- 3.Manual(LED is blue light,handfree operation,FC without any intervention)

**Transmitter setting:**

- 1.Create a new standard fixed-wing model(AIRPLANE),wing type(1AIL),tail type(NORMAL).
- 2.Channel sort definition: ① AIL; ② ELE; ③ THR; ④ RUD; ⑤ AUX(ARM/Dis-ARM); ⑥ MOD(Flight mode).

**FC function:**

- 1.Adjustable sensor and aircraft attitude (can be continuous switched through the flight mode channel, the speed is not too fast, because our remote control switch is a button).
- 2.Adjustable neutral point and rocker stroke (triggered by a button on the FC).

**Aircraft Attitude Correction:**

Power up in 20 seconds, switch remote control flight mode switch 6 times 1 second by 1 second (switch frequency not fast than 1 Hz), green LED on FC Flashing, after 6 seconds, recording the current aircraft attitude is self-stabilizing state of posture (before correction, it is best to place the head of the plane slightly upward).

**Remote Control Stroke Calibration:**

Power up in 20 seconds, press and hold the FC button 3 seconds, green LED flashing, note, green LED flashing is recording to the neutral position of the rocker.(before calibration,Please fine-tuning the plane well first.) note: the rocker can not move when the green LED flashing, the blue LED flashing after 6 seconds, means enter the remote control stroke correction, now, the rocker up and down to the maximum position exercise once, then the LED returns to normal instructions, the correction ends.

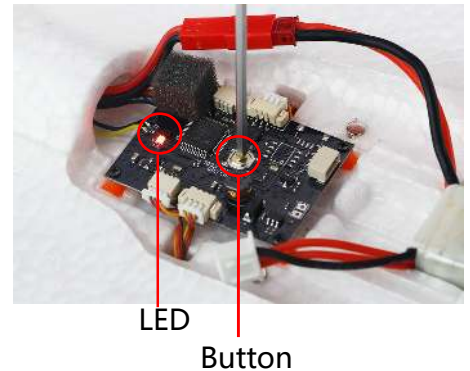

**Note:**

- 1.The calibration button can be only pressed effectively in 20 seconds of first power, power on more than 20 seconds, and then press invalid.
- 2.Neutral point before correction and correcting, rocker can not move.
- 3.The locking switch must be locked before it can enter the correction.

**ESC throttle calibration:(Do not install propeller)**

- 1.Throttle above midstick and power on,keep throttle is above midstick for 3s(8 times Alarm)(Pic1);
- 2.then pull throttle is below midstick and keep 3s(2 times Alarm), throttle calibration finished(Pic2).



**PNP Flight ready work:**

- 1.Stick the EPP accessory well.
- 2.Calibrate aircraft posture, remote control neutral point and rocker stroke (calibration method reference preflight preparation)
- 3.Install the propeller.

**RTF version 450X radio instructions :**

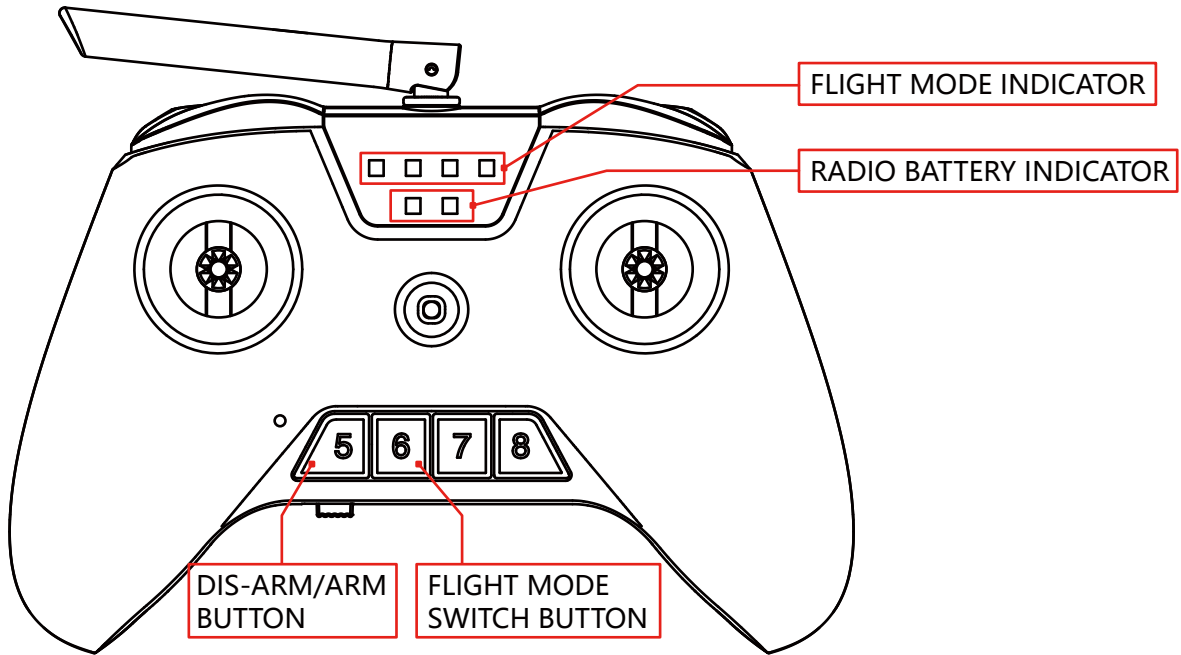

Flight mode indicator on radio ■always on	450X DIS-ARM, the LED on 450X wings will ■always on
	Click the 【DIS-ARM/ARM BUTTON】 on radio will ARM 450X
Flight mode indicator on radio ■always on	450X ARM, the LED on 450X wings will ■always on, fight mode 【SELF LEVEL】 , altitude hold enable
	Click the 【DIS-ARM/ARM BUTTON】 on radio will DIS-ARM 450X
	Click the 【FLIGHT MODE SWITCH BUTTON】 on radio will switch between 【SELF LEVEL】 and 【MIX LEVEL】
Flight mode indicator on radio ■flashing slow	Press the 【FLIGHT MODE SWITCH BUTTON】 3 seconds on radio will switch to 【MANUAL】
	450X ARM, the LED on 450X wings will ■flashing, fight mode 【MIX LEVEL】 , altitude hold enable
	Click the 【DIS-ARM/ARM BUTTON】 on radio will DIS-ARM 450X
Flight mode indicator on radio ■flashing fast	Click the 【FLIGHT MODE SWITCH BUTTON】 on radio will switch between 【SELF LEVEL】 and 【MIX LEVEL】
	Press the 【FLIGHT MODE SWITCH BUTTON】 3 seconds on radio will switch to 【MANUAL】
	450X ARM, the LED on 450X wings will ■always on, fight mode 【MANUAL】 , altitude hold disable
Flight mode indicator on radio ■flashing fast	Click the 【DIS-ARM/ARM BUTTON】 on radio will DIS-ARM 450X
	Click the 【FLIGHT MODE SWITCH BUTTON】 on radio will switch to 【SELF LEVEL】

# KIT Configuration Lists

## KIT



\*2PCS

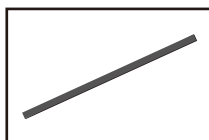

\*4PCS



Stiker\*2PCS

**Include 2PCS KIT**

### Part 1



\*2PCS

### Part 2



\*4PCS



\*4PCS



\*2PCS

### Part 3



Prop\*10PCS  
orange,white,clear

### Part 4



\*2PCS



\*2PCS



\*2PCS



\*2PCS

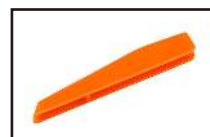

\*4PCS



\*2PCS



\*8PCS

**Orange & Black**

### Part 5



\*4PCS



\*2pairs

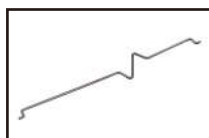

\*4PCS



\*4PCS



ST2.0\*6\*4PCS



ST1.5\*5\*16PCS



Heat shields\*2pairs



M2\*5\*8PCS

### Part6

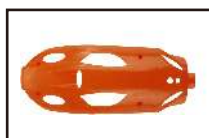

\*1PC



\*1PC



\*2PCS



\*2PCS



\*1PC



Heat shields\*2pairs



M2\*5\*4PCS



ST1.2\*4\*8PCS



## PNP



PNP\*1PC



\*2PCS



Prop\*10PCS  
(orange, white, clear)



M2\*8\*8PCS



Battery\*1PC



Sticker\*1PCS

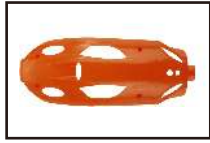

\*1PC



\*1PC



\*2PCS

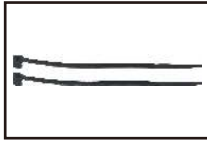

\*2PCS



\*1PC



Heat shields\*2Pairs



M2\*5\*4PCS



ST1.2\*4\*8PCS

## FPV



FPV\*1PC



\*2PCS



Prop\*10PCS  
(orange, white, clear)



M2\*8\*8PCS



Battery\*1PC



Sticker\*1PC

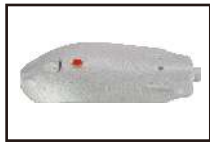

\*1PC

## RTF



PNP\*1PC



\*2PCS



Prop\*10PCS  
(orange, white, clear)



M2\*8\*8PCS



Battery\*1PC



TX\*1PC

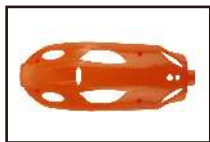

\*1PC



\*1PC



\*2PCS

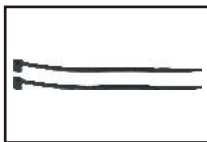

\*2PCS



\*1PC



Sticker\*1PCS



M2\*5\*4PCS



ST1.2\*4\*8PCS



Heat shields\*2Pairs

## FPV install step:

1. Weld OK the FC and VTX connect wire

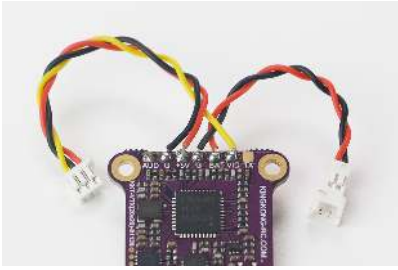

2. Use M2\*3.5 screw install camera, and use glue stick the canopy & magnet together.



3. Connect VTX antenna, stick EVA, and fixed the antenna well.



4. Install VTX, then connect together with FC & camera.

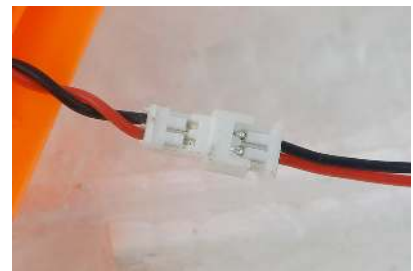
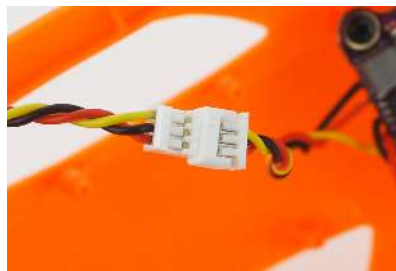
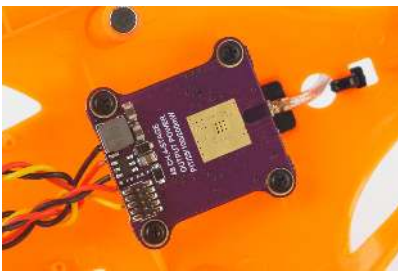

## Install steps:

1. Weld the motor, ESC, FC and power cable together, recommend that the power cable and signal cable cut to 30mm.

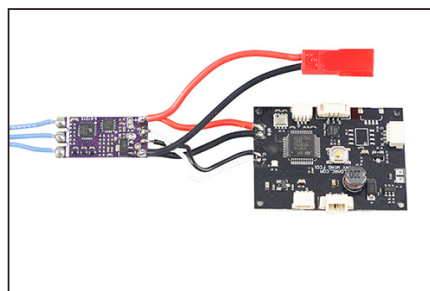
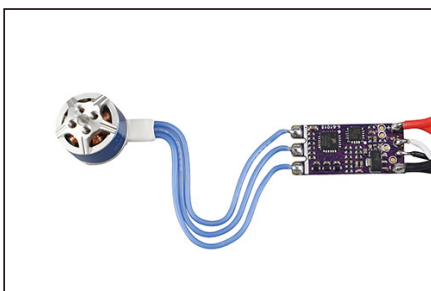

2. Use foam glue to stick EPP, plastic parts, magnets, reinforced bars well

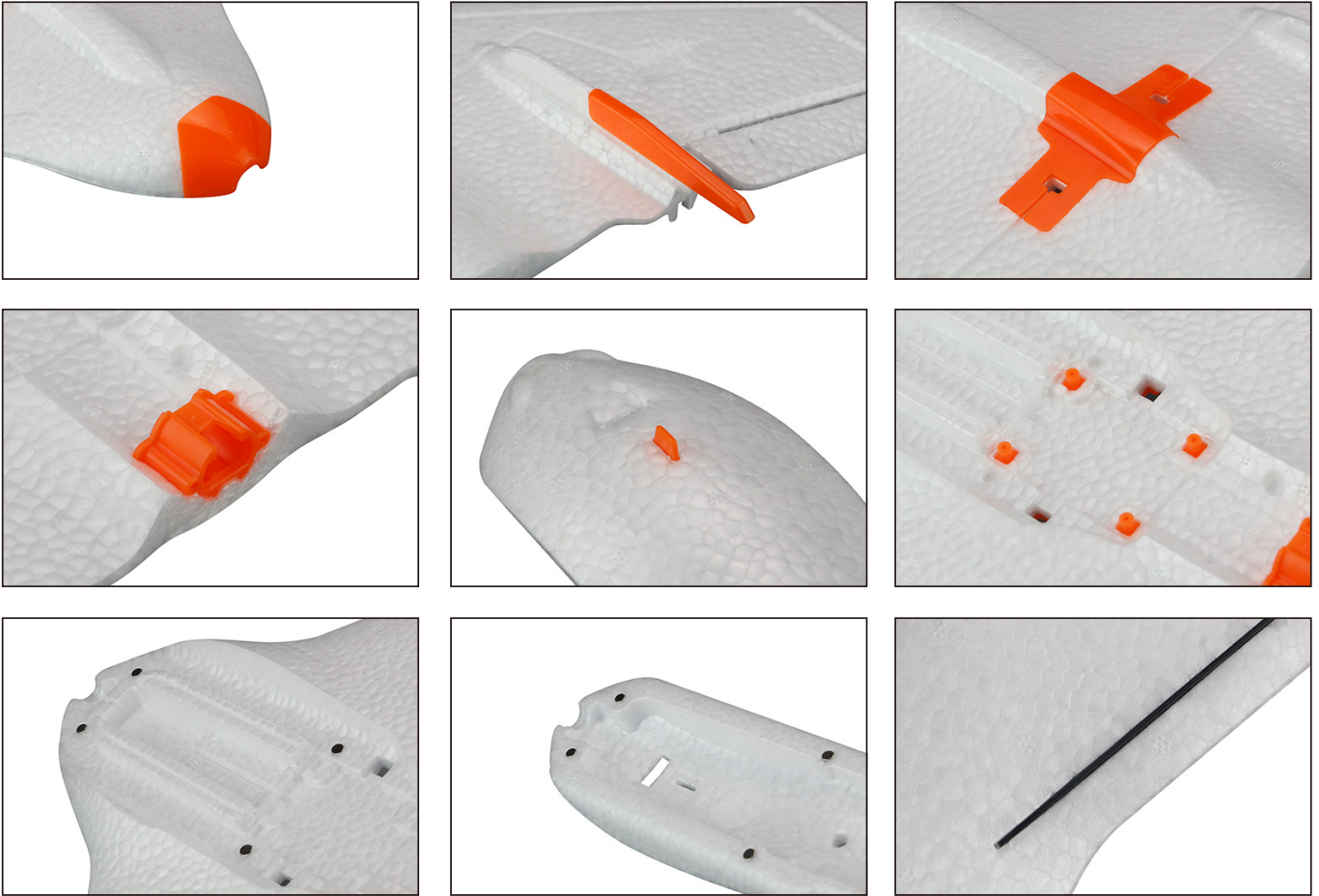

3. Use ST1.5\*5 screw install LED, servo, rudder angle, steel wire rod and lampshade.

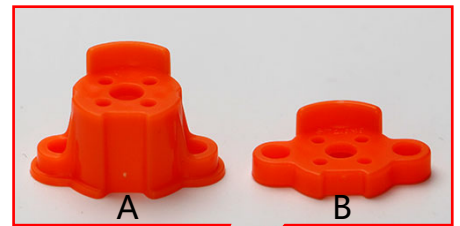
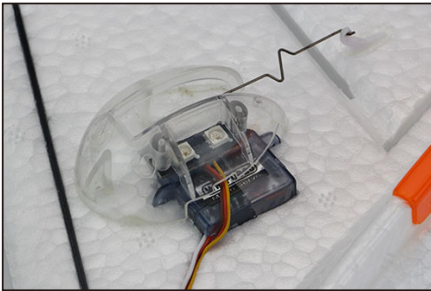

4. Use ST1.5\*5 screw install FC, ST2.0\*6 screw install motor set, then stick the EPP well.

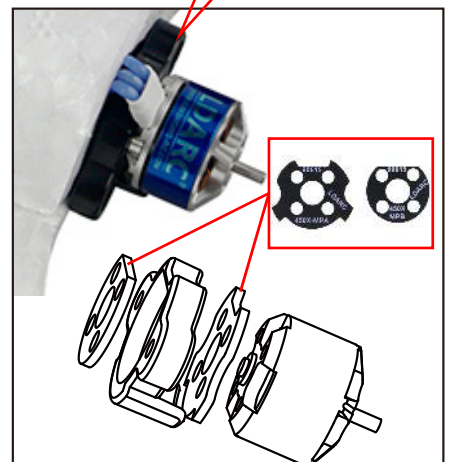
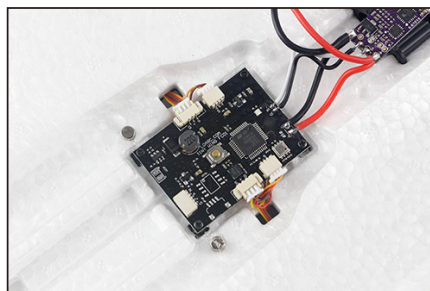

Note: When installing the motor, the motor mount seat need to installed heat shields both inside and outside; FPV version need use A parts install motor