

# Toledo Special 40

Assembly Manual

**HANGAR 9<sup>®</sup>**

*Fly First Class<sup>™</sup>*



## Specifications

Wingspan: ..... 69.5 in (1765.3mm)  
Length: ..... 50.8 in (1290.75mm)  
Wing Area: ..... 702.8 sq in (45.3 sq dm)  
Weight: ..... 5.5–6.25 lb (2.49–2.83 kg)  
Radio: ..... 4-channel w/4–5 servos  
Engine: ..... .40–52 2-stroke; .56–82 4-stroke; Power 46

## Table of Contents

Contents of Kit and Parts Layout .....	2
Included Hardware .....	3
Using the Manual .....	3
UltraCote Covering Colors .....	3
Before Starting Assembly .....	3
Radio Systems Requirements .....	4
Recommended Setup—2-Stroke Glow .....	4
Recommended Setup—4-Stroke Glow .....	4
Recommended Setup—Electric Power (EP) .....	4
Field Equipment Required .....	4
Optional Field Equipment .....	4
Additional Required Tools .....	4
Additional Required Adhesives .....	4
FS One .....	4
Important Information Regarding	
Warranty Information .....	4
Landing Gear Installation .....	5
Tail Installation .....	7
Radio Installation .....	8
Linkage Installation .....	10
2-Stroke Engine Installation .....	12
4-Stroke Engine Installation .....	15
Fuel Tank Installation .....	18
Electric Motor Installation .....	20
Cowling Installation .....	23
Window Installation .....	25
Aileron Servo Installation .....	26
Wing Installation .....	29
Center of Gravity .....	30
Control Throws .....	30
Flight Preparations .....	31
Maintaining Your Model .....	31
Safety Do's and Don'ts for Pilots .....	32
Daily Flight Checks .....	32
Age requirements .....	33
Safety, Precautions and Warnings .....	33
Warranty Information .....	33
CE Compliance Information for the European Union .....	34
2009 Official Academy of	
Model Aeronautics Safety Code .....	35

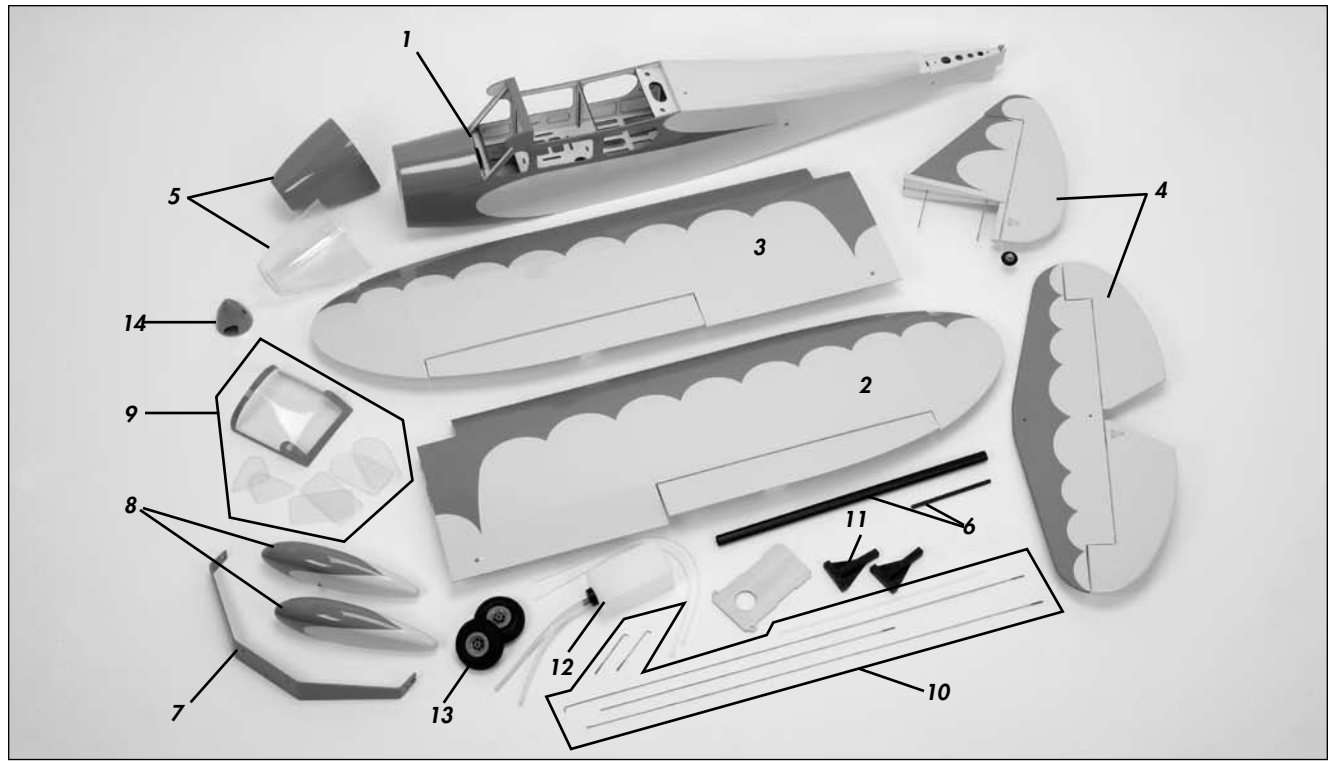

## Contents of Kit and Parts Layout

### Replacement Parts

1.	HAN4861	Fuselage
2.	HAN4862	Right Wing Panel with Aileron
3.	HAN4863	Left Wing Panel with Aileron
4.	HAN4864	Tail Set
5.	HAN4865	Painted Cowling with Template Cowling
6.	HAN4866	Anodized Aluminum Wing Tube Set
7.	HAN4867	Aluminum Landing Gear
8.	HAN4868	Wheel Pants
9.	HAN4869	Window Set
10.	HAN4870	Pushrod Set
11.	HAN1985	Engine Mount with Hardware
12.	HAN1986	Fuel Tank, 11oz
13.	HAN305	Pro-Lite Wheels, 2 <sup>3</sup> / <sub>4</sub> -inch(2)
14.	HAN4872	Blue Plastic Spinner, 2 <sup>1</sup> / <sub>4</sub> -inch

### Items not Shown

HAN3610	2-56 Nylon Clevis (2)
HAN3611	Nylon Control Horn (2)
HAN320	Nylon Wing Bolt, 2 <sup>1</sup> / <sub>2</sub> -inch*
HAN4743	48mm EP Engine Standoff
HAN4871	Decal sheet

\* Will need to be cut down to 1-inch (25mm) for use with this model

## Included Parts Listing

Fuselage	(1)
Right wing with control horn	(1)
Left wing with control horn	(1)
Horizontal stabilizer with control horn	(1)
Vertical fin with control horn	(1)
Cowl with clear cowl template	(1)
Aluminum landing gear	(1)
Wheel pants (left and right)	(2)
Front windshield	(1)
Center window set	(2)
Front window set (right and left)	(2)
Rear window set (right and left)	(2)
16 <sup>3</sup> / <sub>8</sub> x 5/8-inch anodized aluminum wing tube	(1)
5 x 1/4-inch anodized aluminum anti-rotation tube	(1)

## FUSELAGE

4-40 x 3/8-inch socket head cap screw	(3)
#4 flat fender washer	(3)
Nylon clevis	(1)
Pushrod keeper	(1)
Clevis retainer	(1)
Plywood throttle pushrod support	(2)

## MOTOR MOUNT

Small nylon motor mount	(2)
48mm EP standoff	(4)
8-32 x 2 <sup>1</sup> / <sub>4</sub> -inch machine screw (EP)	(4)
8-32 x 3/4-inch machine screw	(4)
8-32 x 1-inch machine screw	(4)
8-32 nylon lock nut	(4)
#8 flat washer	(8)

## WING

20mm x 15mm x 8mm hardwood block	(4)
#4 x 1/2-inch self-tapping washer head screw	(8)
Nylon 1/4-20 x 1 <sup>1</sup> / <sub>2</sub> -inch nylon wing bolt	(2)
Nylon clevis	(2)
Clevis retainer	(2)
Pushrod keeper	(2)
Wing bolt plate	(1)

## RUDDER

Nylon clevis	(1)
Clevis retainer	(1)
Pushrod keeper	(1)

## PUSHRODS

2 <sup>7</sup> / <sub>8</sub> -inch pushrod (aileron)	(2)
25 <sup>1</sup> / <sub>2</sub> -inch pushrod (elevator)	(1)
26-inch pushrod (rudder)	(1)
16 <sup>1</sup> / <sub>2</sub> -inch pushrod (throttle)	(1)
12-inch nylon pushrod housing (throttle)	(1)

## LANDING GEAR

5/32 x 1 <sup>3</sup> / <sub>8</sub> -inch axle with nut	(2)
5/32 wheel collar	(4)
3mm x 5mm machine screw (for wheel collar)	(4)
4-40 x 3/8-inch socket head cap screw	(2)
8-32 x 3/4-inch machine screw	(3)
#4 flat washer	(2)
#8 flat washer	(3)
2 <sup>3</sup> / <sub>4</sub> -inch rubber wheels	(2)

## COWL

2 <sup>1</sup> / <sub>4</sub> -inch nylon spinner, blue	(1)
#4 sheet metal screw (spinner screw)	(2)
4-40 x 1/2-inch socket head cap screw	(4)
#4 washer	(4)
1/4-inch (6mm) fuel tubing	(4)

## ELEVATOR

4-40 nylon lock nut	(2)
#4 flat fender washer	(2)
Nylon clevis	(1)
Clevis retainer	(1)
Pushrod keeper	(1)

## MISCELLANEOUS

EP plywood battery tray	(1)
Fuel tank assembly, 11 oz	(1)
Nylon tie-wrap	(2)
Velcro strap	(2)
1.5mm hex wrench	(1)

## Using the Manual

This manual is divided into sections to help make assembly easier to understand, and to provide breaks between each major section. In addition, check boxes have been placed next to each step to keep track of each step completed. Steps with a single box (☐) are performed once, while steps with two boxes (☐☐) indicate that the step will require repeating, such as for a right or left wing panel, two servos, etc. Remember to take your time and follow the directions.

## UltraCote® Covering Colors

• Cream	HANU878
• Sky Blue	HANU875

## Before Starting Assembly

Before beginning the assembly of your model, remove each part from its bag for inspection. Closely inspect the fuselage, wing panels, rudder and stabilizer for damage. If you find any damaged or missing parts, contact the place of purchase.

If you find any wrinkles in the covering, use a heat gun or covering iron to remove them. Use caution while working around areas where the colors overlap to prevent separating the colors.



HAN100 – Heat Gun

HAN150 – Covering Glove



HAN101 – Sealing Iron

HAN141 – Sealing Iron Sock

## Radio Systems Requirements

### Spektrum Radio System

- DX6i 6-channel radio or greater with receiver (SPM6600)
- JRPS821 DS821 Digital Sport Servo (5) (4 required for EP version)
- JSP98110 6-inch Servo Extension (2)
- JSP98020 Y-Harness or JSP98110 6-inch Servo Extension (2) for receiver to aileron servos
- JR Switch, Chargeswitch (JRPA004)
- Receiver battery, 2700mAh

### Optional

- JSP98020 Y-Harness or JSP98110 6-inch Servo Extension to connect the float rudder servo to the receiver.

### Recommended Setup—2-Stroke Glow

- Evolution® .46NX with Muffler (EVOE0461)
- Evolution Propeller 11 x 5 (EVO11050) to 11 x 6 (EVO11060)

### Recommended Setup—4-Stroke Glow

- Saito™ .82 AAC w/Muffler (SAIE082AGK or SAIE082A)
- Evolution Propeller 13 x 8 (EVO13080) or 14 x 6 (EVO14060)

### Recommended Setup— Electric Power (EP)

- E-flite® Power 46 BL Outrunner Motor (EFLM4046A)
- 60-Amp Pro Switch-Mode BEC Brushless ESC (EFLA1060)
- Thunder Power 4S 3850–4500mAh LiPo Battery Pack
- APC Propeller 13x6.5-inch (APC13065E) to 14x7 (APC14070E)

### Field Equipment Required

- Fuel (15% recommended)
- Propeller
- Long Reach Glow Plug Wrench (HAN2510)
- Metered Glow Driver w/Ni-Cd & Charger (HAN7101)
- 2-Cycle Sport Plug (EVOGP1)
- Manual Fuel Pump (HAN118)

## Optional Field Equipment

- Self-stick weights, 6 oz (HAN3626)
- PowerPro 12V Starter (HAN161)
- 12V 7Ah Sealed Battery (HAN102)
- Power Panel (HAN106)
- Blue Block After Run Oil (EVOX1000)
- Cleaner and towels

### Additional Required Tools

Drill	File
Pin drill	Pliers
Ruler	Scissors
Side cutters	Flat blade screwdriver
Hobby knife with #11 blade	Small clamps
Medium grit sandpaper	Z-bend Pliers (HAN119)
Phillips screwdriver: #1, #2	Hook and loop tape
Low-Tack Tape (MMM209034)	
Box wrench to fit propeller nut	
Box end or open end wrench: 1/4-inch, 7/16-inch, 1/2-inch	
Hex wrench or ball driver: 3/32-inch	
Drill bit: 5/64-inch (2mm), 5/32-inch (4mm)	

### Additional Required Adhesives

Canopy Glue	(PAAPT56)
Medium CA	(PAAPT02)
Thin CA	(PAAPT08)
Threadlock	(PAAPT42)
30-Minute Epoxy, 8 oz	(PAAPT39)

## FS One®

With FS One (HANS2000) you get more than photorealistic fields, gorgeous skies and realistic-looking aircraft. You get incredibly advanced aerodynamic modeling that simulates every possible aspect of real-world flight.

The first Hangar Pack® (HANS4010) will add even more aircraft to FS One. This latest edition includes ten new planes and helis from your favorite brands, including Hangar 9, E-flite and Align. You'll be able to fly aircraft that are only available on FS One such as the T-REX, Blade CX2, Blade CP Pro, Hangar 9 P-51 and F-22 PTS. And as always, with the Hangar Pack, you still get all the same great features that you did with the original aircraft.



HANS2008

HANS4010

### Important Information Regarding Warranty Information

Please read our Warranty and Liability Limitations section on Page 33 before building this product. If you as the purchaser or user are not prepared to accept the liability associated with the use of this Product, you are advised to return this Product immediately in new and unused condition to the place of purchase.

The Spektrum trademark is used with permission of Bachmann Industries, Inc.

**Hangar 9 Toledo Special Assembly Manual**

## Landing Gear Installation

### Required Parts

Fuselage assembly	#4 washer (2)
#8 washer (3)	Main landing gear
Wheel axle with nut (2)	5/32-inch wheel collar (4)
Wheel pant (right and left)	
Wheel, 2 <sup>3</sup> / <sub>4</sub> -inch (70mm) (2)	
3mm x 5mm machine screw (4)	
8-32 x 3/4-inch machine screw (3)	
4-40 x 3/8-inch socket head screw (2)	

### Tools and Adhesives

Phillips screwdriver: #1, #2    Threadlock  
Flat file  
Box wrench: 7/16-inch, 1/2-inch  
Hex wrench or ball driver: 3/32-inch

### □ Step 1

Locate the main landing gear, wheels, wheel pants and the bag marked landing gear. Open all the part bags and set the parts where they can be easily accessed.

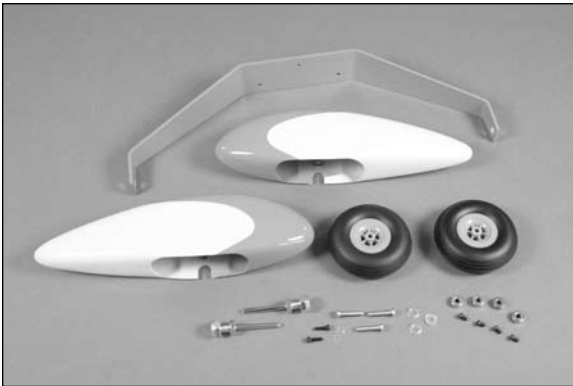

### □ Step 2

The main landing gear is mounted to the bottom of the fuselage using three 8-32 x 3/4-inch machine screws and three #8 washers. Apply a drop of threadlock on each of the screws. Use a #2 Phillips screwdriver to tighten the screws to secure the landing gear to the bottom of the fuselage.

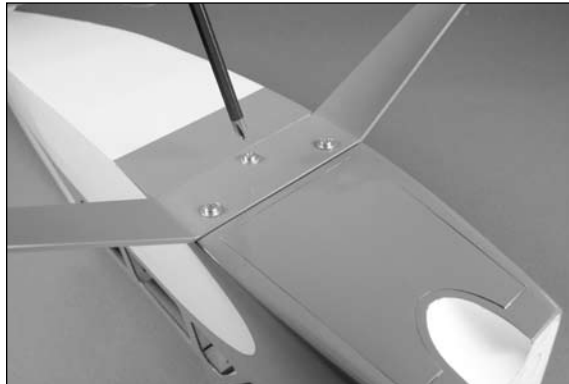

### □□ Step 3

Attach the wheel axle to the landing gear using a 7/16-inch box wrench (axle) and 1/2-inch box wrench (nut). Make sure the nut on the axle side aligns with the landing gear as shown in the photo so the wheel pant can be installed.

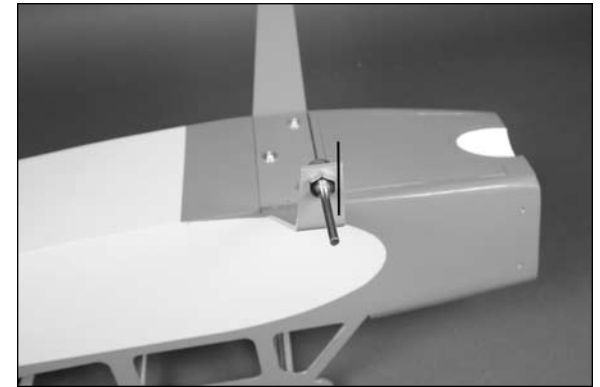

#### □□ Step 4

Use the narrow edge of a flat file to make two flat spots on the wheel axle that faces the bottom of the fuselage. These will be the areas that the screws for the wheel collars will tighten into. The flat areas will keep the wheel collars more secure than if the axle were round.

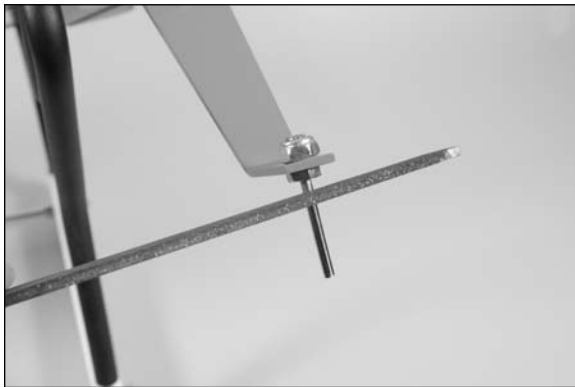

#### □□ Step 5

Attach a 5/32-inch wheel collar to the axle using a 3mm x 5mm machine screw. Make sure to apply threadlock to the screw so it will not vibrate loose. Position the collar so it is 7/16-inch (11mm) from the landing gear as shown and use a #2 Phillips screwdriver to tighten the screw on the flat area of the axle. The position of the wheel may need to be fine-tuned in the last step of this section.

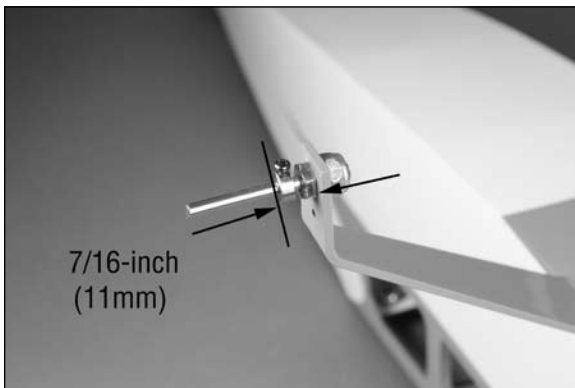

#### □□ Step 6

Slide the wheel on the axle. Use a 5/32-inch wheel collar and a 3mm x 5mm machine screw to secure the collar. Make sure to position the collar so the wheel can rotate freely on the axle. Use a #2 Phillips screwdriver to tighten the screw on the flat area of the axle.



#### □□ Step 7

Slip the wheel pant over the wheel. The wheel pant is secured to the landing gear using a 4-40 x 3/8-inch socket head screw and #4 washer. Apply a drop of threadlock on the screw before using a 3/32-inch hex wrench or ball driver to tighten the screw.



#### □ Step 8

Repeat Steps 3 through 7 to install the remaining wheel and wheel pant.



#### □ Step 9

Position the wheels so they are centered side to side inside the wheel pant. You will need to loosen the wheel collars to do so. Also make sure the wheel can rotate freely without binding.

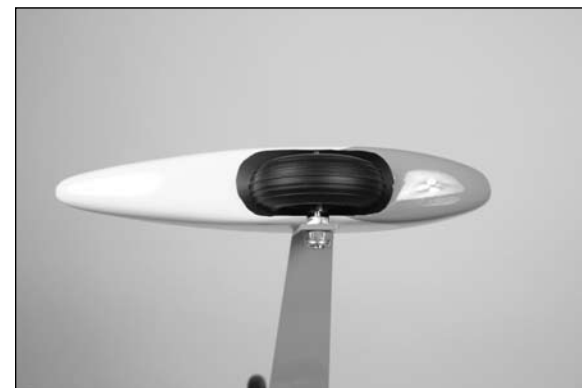

**Hint:** Apply a small drop of lightweight oil to help the wheels to roll smoothly.

## Tail Installation

### Required Parts

Fuselage assembly	Horizontal fin assembly
Vertical fin assembly	#4 fender washer (2)
4-40 lock nut (2)	

### Tools and Adhesives

Nut driver or box wrench: 1/4-inch

#### Step 1

Open the bag marked elevator. Set aside the clevis, clevis retainer and pushrod keeper for installation in the next section of the manual.

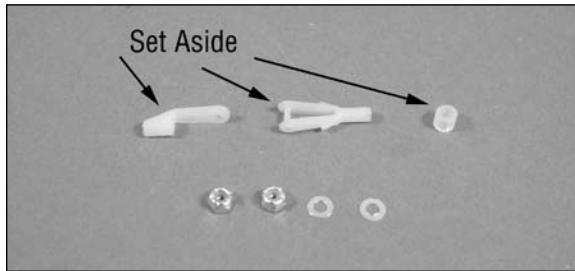

#### Step 2

Locate the vertical and horizontal stabilizers. Slide the threaded rods from the vertical stabilizer through the holes in the horizontal stabilizer. Make sure the blue trim on the horizontal stabilizer faces up toward the vertical stabilizer as shown in the photo below.



#### Step 3

Slide the horizontal and vertical stabilizers tightly together as shown. You will need to deflect the rudder to allow the rudder control horn to pass by the elevator.

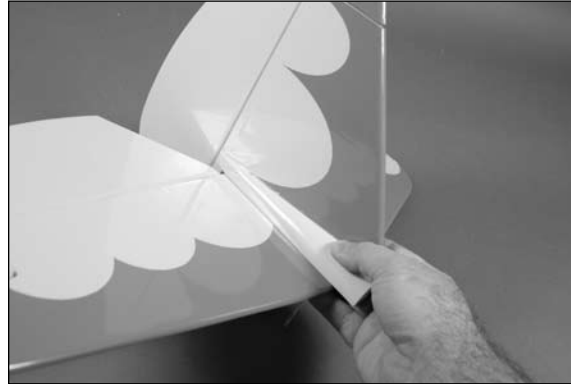

#### Step 4

Slide the threaded rods into the holes in the aft end of the fuselage as shown.



#### Step 5

Slide the tail assembly tightly against the fuselage. Make sure to guide the portion of the vertical stabilizer with the tail wheel carefully into the slot at the rear of the fuselage so the fuselage is not damaged by side loads.

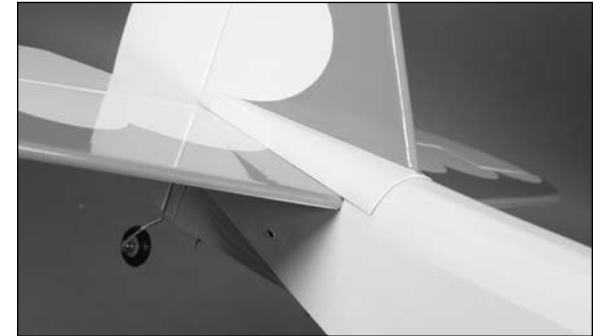

#### Step 6

Secure the tail assembly to the fuselage using two #4 fender washers and two 4-40 lock nuts. Use a 1/4-inch nut driver or box wrench to tighten the nuts. Make sure not to over-tighten the nuts and accidentally damage the sub-fin or fuselage.



## Radio Installation

### Required Parts

Fuselage assembly	Receiver
Receiver battery	Switch harness
Hook and loop strap	Radio foam
Y-harness (1) or 6-inch (152mm) servo extension (2)	
Servo with hardware (3)	
(2 if constructing the EP version)	

### Tools and Adhesives

Phillips screwdriver: #1	Thin CA
Hobby knife with #11 blade	Hook and loop tape
Scissors	

#### □ Step 1

Install the grommets and brass eyelets in three servos for the elevator, rudder and throttle.



**Note:** If you are building the EP version, you only need to prepare two servos for rudder and elevator at this time.

#### □ Step 2

Use a #1 Phillips screwdriver to thread a servo mounting screw into the holes in the radio tray for mounting the servos. Apply a drop or two of thin CA into each hole to harden the threads made by the screw. This will provide a much more secure mounting of the servos than if this step were skipped.

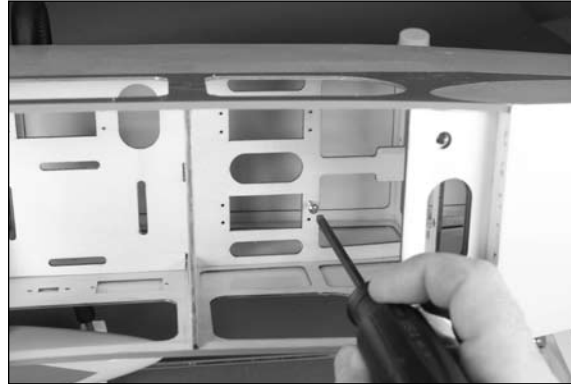

#### □ Step 3

Use the hardware to mount the rudder and elevator servos in the servo tray. Make sure the output of the servos face to the rear of the fuselage. Tighten the screws using a #1 Phillips screwdriver. Make sure to guide the leads from the servos through the hole behind the opening for the throttle servo when placing the servos in the radio tray.

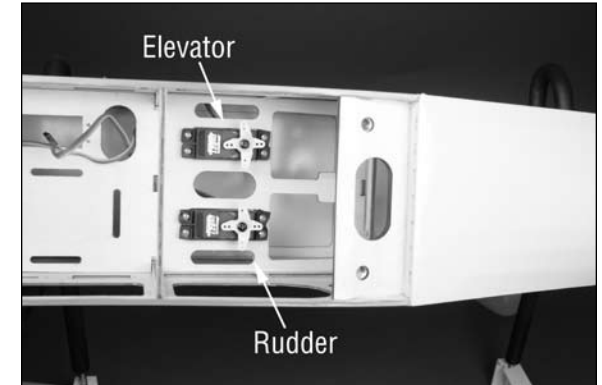

#### □ Step 4

Mount the throttle servo in the radio tray as shown using a #1 Phillips screwdriver and the screws provided with the servo.



**Note:** If you are building the EP version you will not need to install the throttle servo.



### □ Step 5

Measure and cut a 3¼-inch piece of foam from the supplied foam blocks using scissors.

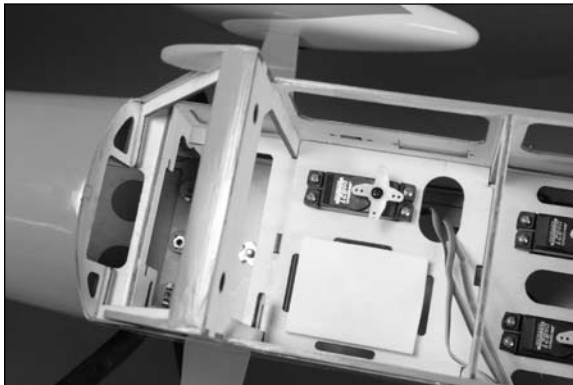
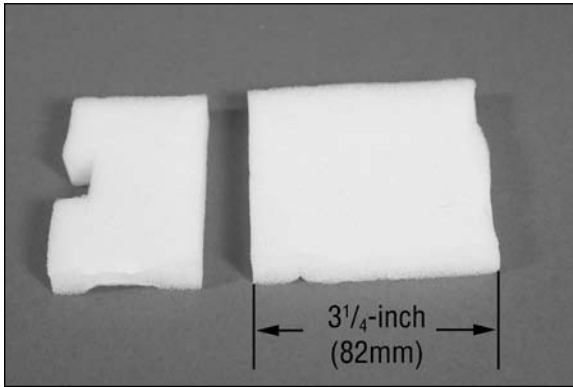

**Note:** Use only a few drops of CA so the foam can be removed if it ever needs to be replaced.

### □ Step 6

Open the bag marked Misc and remove one of the hook and loop straps. Insert the strap through the slots as shown in the photo.

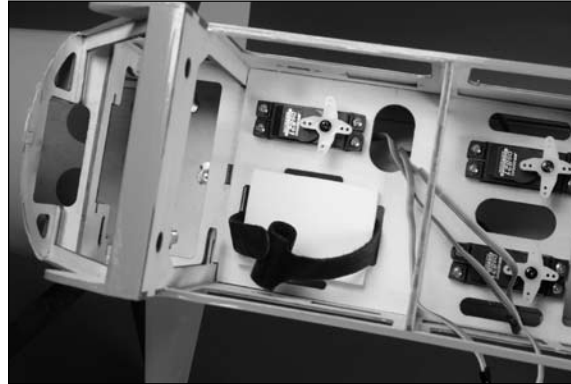

### □ Step 7

There are two different holes in the side of the fuselage that should match your particular switch. Use a hobby knife to remove the covering from the appropriate hole. Mount the switch harness in the side of the fuselage using the hardware provided with your switch.



**Note:** Do not cut any switch locations if you are building the airplane and installing an electric motor. This will be covered in the Electric Motor Installation starting on Page 20.

### □ Step 8

Plug the rudder, elevator and throttle servos into the receiver. The lead from the switch should also be plugged in at this time. Finally, plug the Y-harness or 6-inch (152mm) servos extensions for the aileron servos into the receiver.

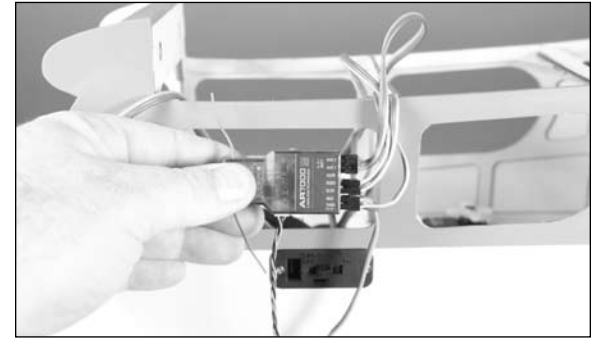

**Note:** When using two 6-inch (152mm) extensions, you will need to use a computer radio with dual aileron mixing or programmable mixing. Plug the extensions into the aileron channel and the AUX channel that corresponds to the opposite aileron channel.

### □ Step 9

Connect the receiver battery to the switch harness. Place the battery on the foam, then place a piece of foam on the battery. The receiver mounts on the battery with a piece of foam between the receiver and hook and loop strap, and everything is secured by the hook and loop strap installed in Step 6.

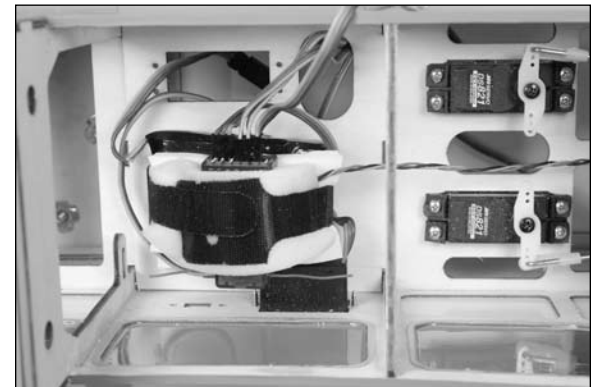

**Note:** EP version shown without throttle servo installed. Glow receiver installation is identical.

### □ Step 10

Use a piece of hook and loop tape (not included) to mount the remote receiver at the rear of the servo tray as shown.

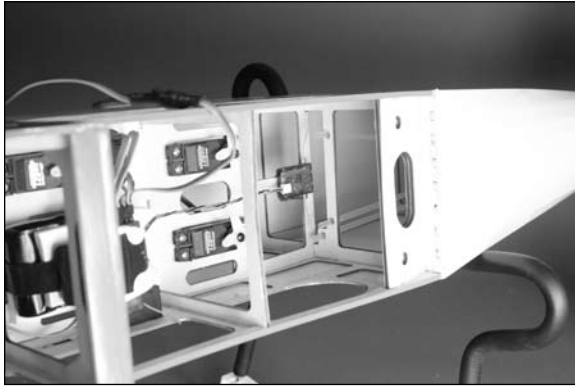

## Linkage Installation

### Required Parts

Fuselage assembly	Transmitter
Clevis (2)	Clevis retainer (2)
Pushrod keeper (2)	26-inch pushrod (rudder)
25½-inch pushrod (elevator)	
180-degree servo horn (2)	

### Tools and Adhesives

Phillips screwdriver: #1	Pin drill
Drill bit: 5/64-inch (2mm)	Ruler
Pliers	

### □ Step 1

Start with a new model if you are using a computer radio. Make sure the trims and sub trims are set to 0 and there are no mixing options turned on as well. Check the radio system by turning on the receiver and transmitter. It may be necessary to bind the transmitter and receiver if you are using a new receiver. Follow the instructions provided with your radio system regarding binding if necessary. Remove the horns from the servos inside the fuselage at this time using a #1 Phillips screwdriver.

### □ Step 2

Open the bag marked rudder and remove the clevis, clevis retainer and pushrod keeper. You will also need these three items that were in the bag marked elevator. You will also need to remove the 25½-inch elevator pushrod and 26-inch rudder pushrod from the bag marked pushrod set for this section of the manual.

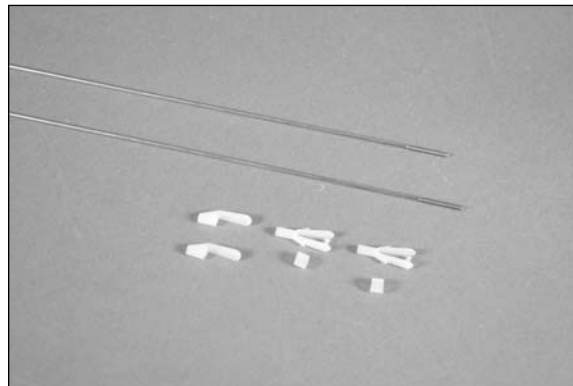

### □ Step 3

Locate two 180-degree servo horns. Enlarge the holes that are 9/16-inch (14mm) from the center of the horn as shown using a pin drill and 5/64-inch (2mm) drill bit.

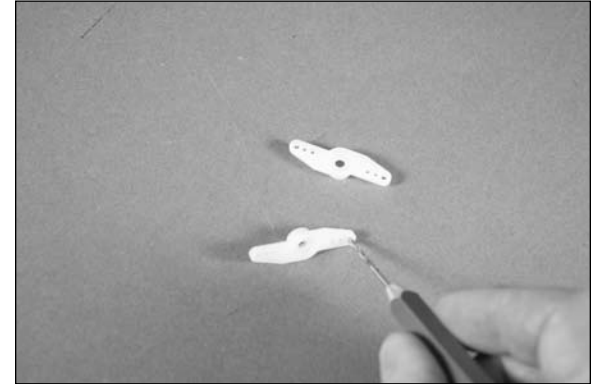

### □ Step 4

With the radio system on and the trims (and sticks) centered, attach the servo horns to the rudder and elevator servos. Use the screws from the servo and a #1 Phillips screwdriver to secure the horn.



**Hint:** Most servos have an odd number of splines. If the horn is not aligned correctly as shown, you can rotate it 180 degrees to bring it into alignment.

### □□ Step 5

Slide the 26-inch rudder pushrod into the tube in the fuselage. Make sure to use the upper tube, as the tube below it is for use to route the antenna for a 72MHz receiver.



### □□ Step 6

Insert the bend on the pushrod wire through the hole in the servo horn that was enlarged in Step 3. Slide the pushrod keeper onto the portion of the wire below the servo horn. The keeper is then rotated and snapped on the pushrod to secure the connection between the servo horn and pushrod. You may need to use pliers to snap the connector in position.

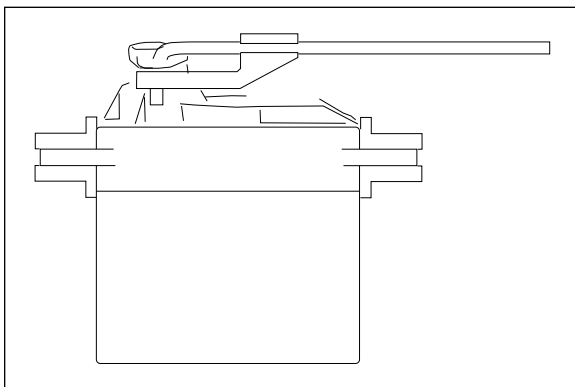

### □ Step 7

Repeat Steps 5 and 6 to install the 25 $\frac{1}{2}$ -inch elevator pushrod and secure it to the elevator servo horn.

**Hint:** If you have larger hands, you can always remove the servo horns to make the connections outside the fuselage. Just remember to orient the servo horns the same as they are inside the fuselage so they remain aligned when reinstalled on the servos.

### □□ Step 8

Slide a clevis retainer on one clevis. Thread the clevis on the elevator pushrod wire. With the radio system on, connect the clevis to the center hole of the elevator control horn. Use a ruler to check that the elevator and stabilizer are in alignment. If not, you will need to thread the clevis in or out so when the elevator servo is centered, the elevator is in alignment at the same time.

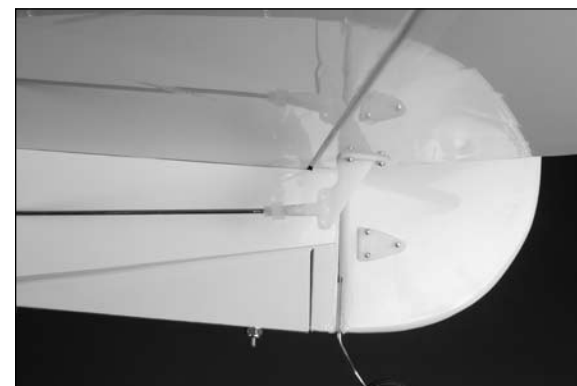
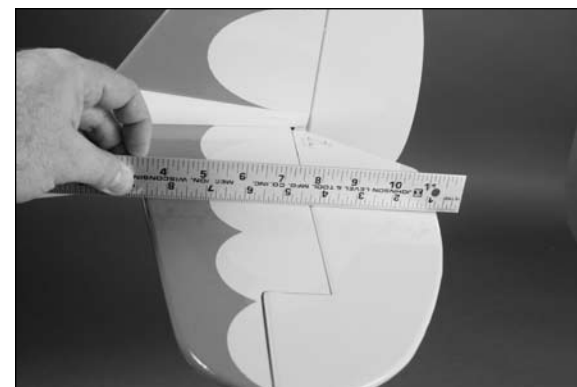

### □ Step 9

Repeat Step 8 to complete the installation of the rudder and elevator linkages. Connect the clevis to the center hole of the rudder control horn.



## 2-Stroke Engine Installation

### Required Parts

Fuselage assembly	Motor mount (2)
#8 washer (8)	8-32 Lock nut (4)
Clevis	Clevis retainer
Engine	Pushrod keeper
Pushrod tube, 12-inch (305mm)	
8-32 x 1-inch machine screw (4)	
8-32 x 3/4-inch machine screw (4)	
Throttle pushrod, 16 1/2-inch (420mm)	

### Tools and Adhesives

Ruler	Threadlock
Phillips screwdriver: #1, #2	Felt-tipped pen
Medium grit sandpaper	Medium CA
Drill	Clamp
Drill bit: 5/64-inch (2mm), 5/32-inch (4mm)	
Box wrench or nut driver: 11/32-inch	

### □ Step 1

Locate the items to install the engine to your aircraft. You will find these in the bags marked Pushrod Set and Motor Mount. Set aside the four 1 7/8-inch (48mm) EP standoffs and the 8-32 x 2 1/4-inch machine screws as they are not used when installing glow engines.

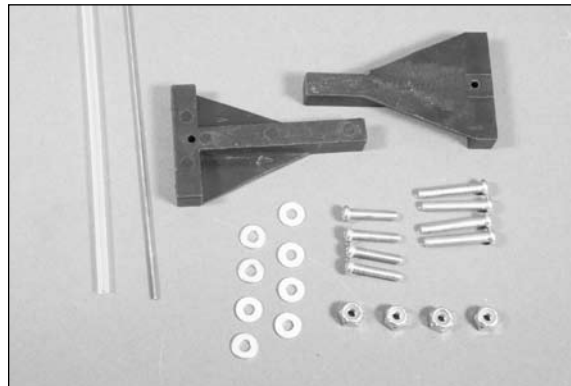

### □ Step 2

Secure the mounts to the firewall using four 8-32 x 3/4-inch machine screws and four #8 washers. Make sure to place a drop of threadlock on each of the screws to prevent them from vibrating loose.



**Note:** Blind nuts have been installed for both glow and EP versions. Make sure to position the mounts at an angle as shown.

### □ Step 3

Slide the engine between the mounts. Use a felt-tipped pen to mark the locations for the throttle pushrod tube on the firewall.



#### □ Step 4

Use a drill and 5/32-inch (4mm) drill bit to drill a hole through the firewall at the mark made in the previous step.

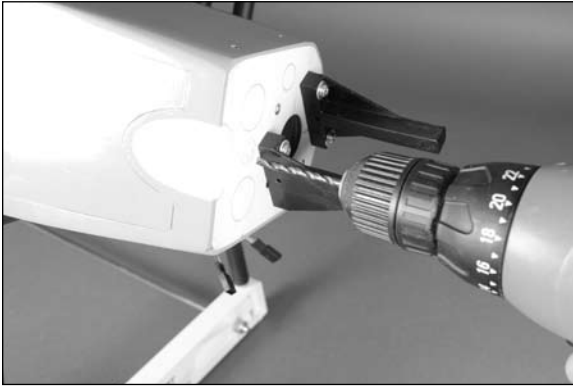

#### □ Step 5

Use medium grit sandpaper to scuff the outside of the 12-inch (305mm) pushrod tube. This will provide a better surface for the CA to adhere to when gluing the tube in position.

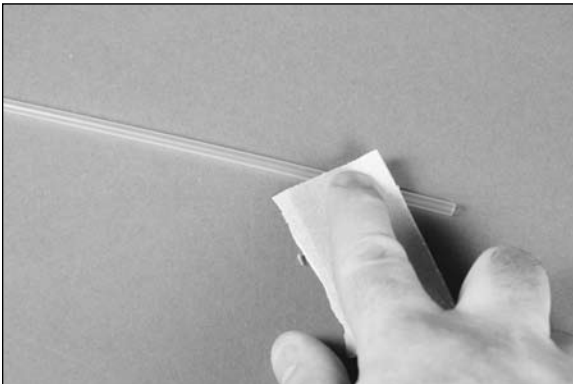

#### □ Step 6

Insert the throttle tube into the hole drilled in Step 4. Leave roughly 1 1/2-inch (38mm) exposed. Use medium CA to glue the tube to the firewall.

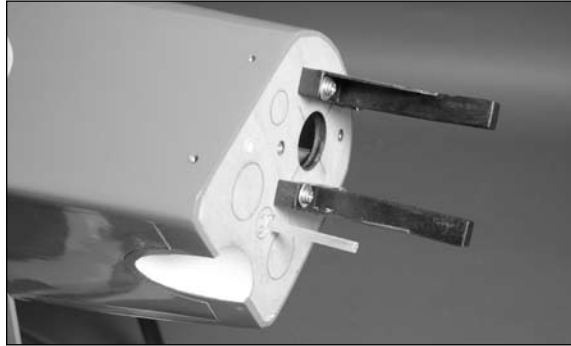

#### □ Step 7

Position the engine on the mounts so the face of the drive washer is 4 1/2-inches (114mm) forward of the firewall. Use a pencil or drill bit to transfer the locations for the engine mounting bolts onto the engine mounts. Use a clamp to hold the position of the engine while marking the engine mounts.

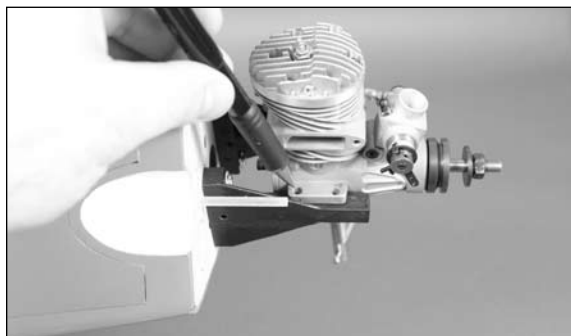
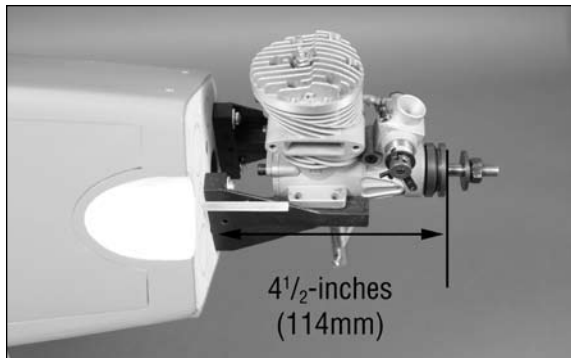

#### □ Step 8

Use a drill and 5/32-inch (4mm) drill bit to drill the holes for the engine mounting screws in the engine mounts.

**Hint:** If you have access to a drill press, it is highly recommended that you use it. Using a drill press for drilling these holes will guarantee they are straight.

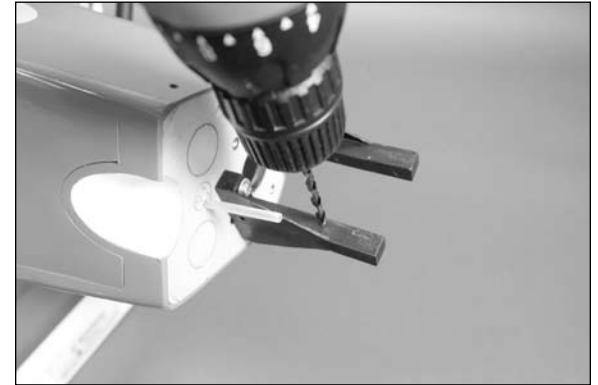

#### □ Step 9

Use four 8-32 x 1-inch machine screws, four #8 washers and four 8-32 lock nuts to secure your engine to the mounts. Use a #2 Phillips screwdriver and 11/32-inch box wrench or nut driver to tighten the hardware.



**Step 10**

Use side cutters to trim the pushrod tube at the forward end of the servo as shown.



**Step 11**

Open the bag marked fuselage. Remove the clevis retainer and slide it onto the clevis from the bag. The clevis is then threaded 10 turns on the 16 $\frac{1}{2}$ -inch (420mm) pushrod.

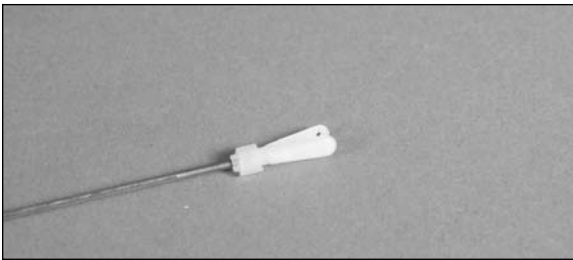

**Step 12**

Slide the pushrod into the pushrod tube. Connect the clevis to the outer hole of the carburetor arm.

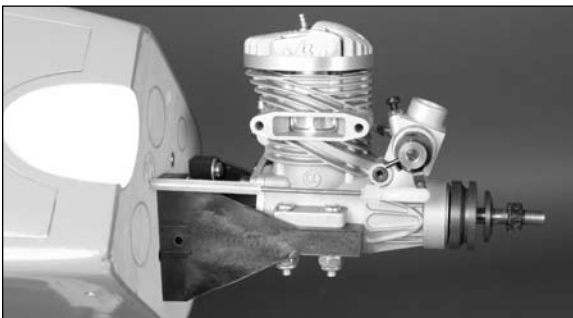

**Step 13**

Use a 5/64-inch (2mm) drill bit to enlarge the hole that is 9/16-inch (10mm) from the center of a 180-degree servo horn. Use side cutters to remove the opposite arm from the servo horn.

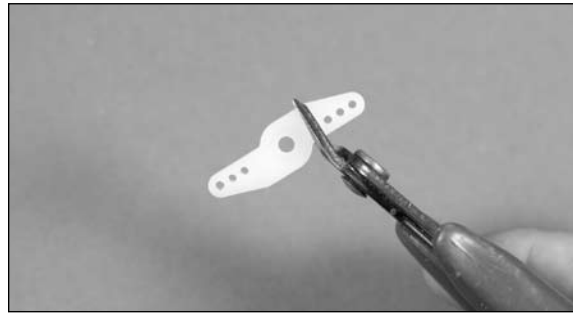
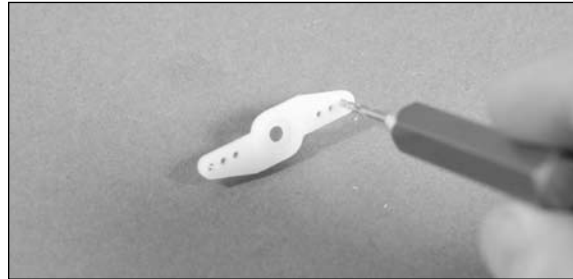

**Step 14**

Center the throttle stick and trim. Secure the servo horn to the throttle servo using the screw provided with the servo using a #1 Phillips screwdriver. Attaching the horn using this method will give equal movement of the horn to both low throttle and full throttle.



**Step 15**

Use the radio system to move the throttle to the low position. Physically move the carburetor to the closed position. Use a felt-tipped pen to mark the pushrod where it crosses the hole in the servo horn enlarged previously.

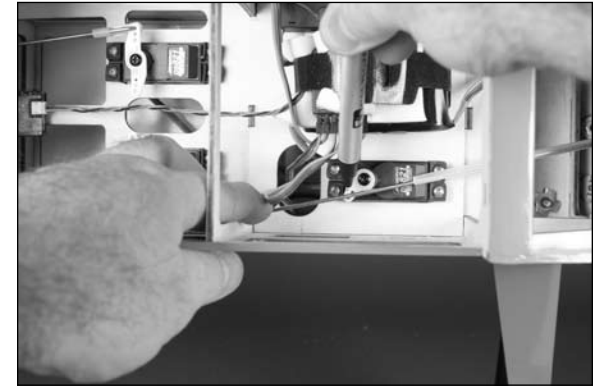

**Note:** Check to make sure the servo will move the carburetor in the correct directions before proceeding. In most cases, the servo arm will angle back for closed. Check to make sure that operating the carburetor linkage manually and the direction the servo operates in provides the correct results.

**Step 16**

Slide one of the plywood throttle tube supports on the throttle tube as shown. Two supports have been provided, but only one is necessary to support the throttle tube near the servo.



### □ Step 17

Make a 90-degree bend in the pushrod wire at the mark made in the previous step. Trim the wire 3/8-inch (9mm) above the bend. Insert the bend through the hole in the servo horn and secure the pushrod to the servo horn using a pushrod keeper.



### □ Step 18

Check the operation of the carburetor and that it can move from open to closed using the radio system. You may need to use the end point adjustments in the radio programming to fine-tune the operation of the throttle.

### □ Step 19

Use medium CA to glue the throttle tube support to the fuselage side and to the pushrod tube.



## 4-Stroke Engine Installation

### Required Parts

Fuselage assembly	Motor mount (2)
#8 washer (8)	8-32 lock nut (4)
Clevis	Clevis retainer
Engine	
Pushrod tube, 12-inch (305mm)	
8-32 x 1-inch machine screw (4)	
8-32 x 3/4-inch machine screw (4)	
Throttle pushrod, 16 1/2-inch (420mm)	

### Tools and Adhesives

Ruler	Threadlock
Phillips screwdriver: #2	Felt-tipped pen
Medium grit sandpaper	Medium CA
Drill	Drill bit: 5/32-inch (4mm)
Clamp	
Box wrench or nut driver: 11/32-inch	

### □ Step 1

Locate the items to install the engine to your aircraft. You will find these in the bags marked Pushrod Set and Motor Mount. Set aside the 1 7/8-inch (48mm) EP standoffs and the 8-32 x 2 1/4-inch machine screws as they are not used when installing glow engines.

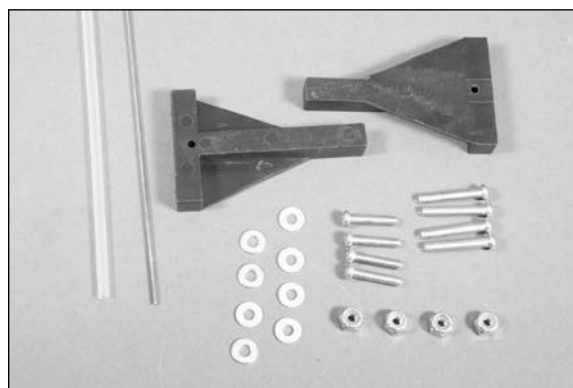

### □ Step 2

Secure the mounts to the firewall using four 8-32 x 3/4-inch machine screws and four #8 washers. Make sure to place a drop of threadlock on each of the screws to prevent them from vibrating loose.

**Note:** Blind nuts have been installed for both glow and EP versions. Make sure to position the mounts at an angle as shown.



### □ Step 3

Slide the engine between the mounts. Use a felt-tipped pen to mark the locations for the throttle pushrod tube on the firewall.



**Note:** It may be necessary to rotate the carburetor to match the photo below. Follow the instructions included with your engine if repositioning the carburetor is necessary.

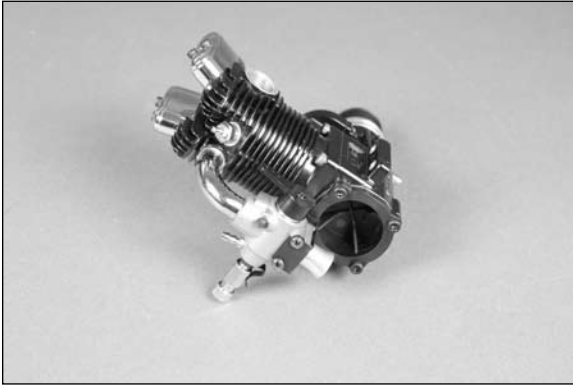

#### □ Step 4

Use a drill and 5/32-inch (4mm) drill bit to drill a hole through the firewall at the mark made in the previous step.

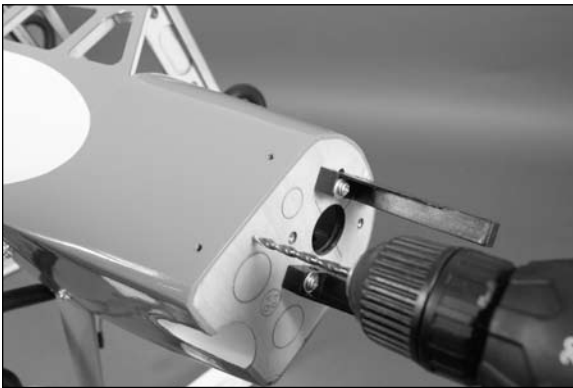

#### □ Step 5

Use medium grit sandpaper to scuff the outside of the 12-inch (305mm) pushrod tube. This will provide a better surface for the CA to adhere to when gluing the tube in position.

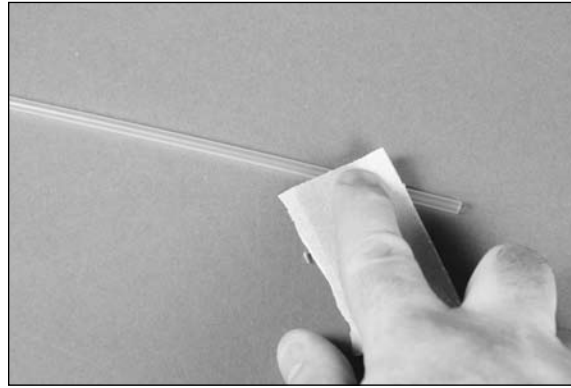

#### □ Step 6

Insert the throttle tube into the hole drilled in Step 4. Leave roughly 1/8-inch (3mm) of the tube exposed so it will not interfere with the operation of the throttle. Use medium CA to glue the tube to the firewall.

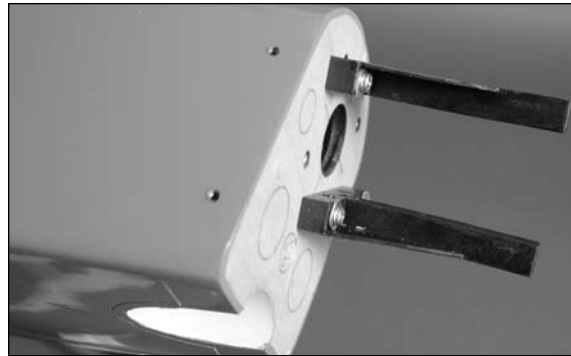

#### □ Step 7

Position the engine on the mounts so the face of the drive washer is 4 1/2-inches (114mm) forward of the firewall. Use a pencil or drill bit to transfer the locations for the engine mounting bolts onto the engine mounts. Use a clamp to hold the position of the engine while marking the engine mount.

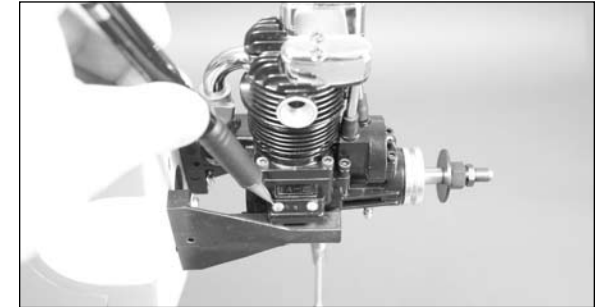
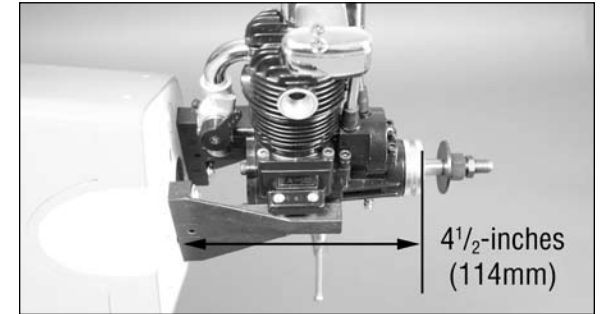

#### □ Step 8

Use a drill and 5/32-inch (4mm) drill bit to drill the holes for the engine mounting screws in the engine mounts.

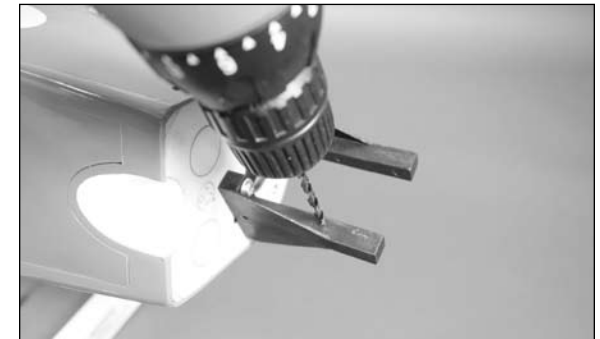

**Hint:** If you have access to a drill press, it is highly recommended that you use it. Using a drill press for drilling these holes will guarantee they are straight.



### □ Step 9

Use four 8-32 x 1-inch machine screws, four #8 washers and four 8-32 lock nuts to secure your engine to the mounts. Use a #2 Phillips screwdriver and 11/32-inch box wrench or nut driver to tighten the hardware.

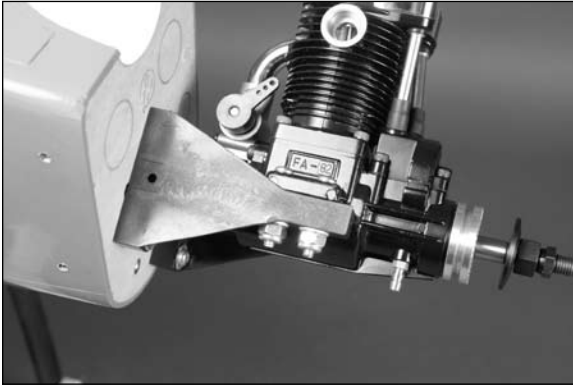

### □ Step 10

Use side cutters to trim the pushrod tube at the forward end of the servo as shown.



### □ Step 11

Slide one of the plywood throttle tube supports on the throttle tube as shown. Two supports have been provided, but only one is necessary to support the throttle tube near the servo.



### □ Step 12

Use side cutters to remove one of the arms from a 180-degree servo horn.

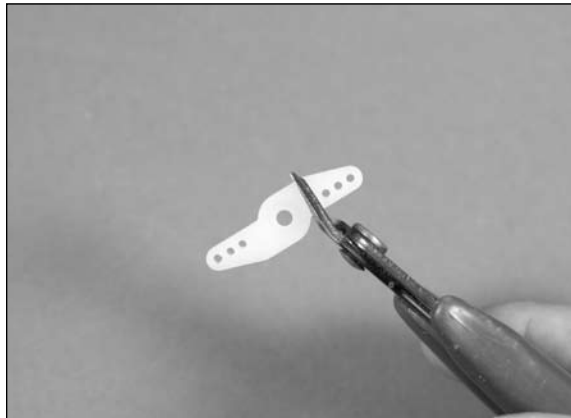

### □ Step 13

Center the throttle stick and trim. Secure the servo horn to the throttle servo using the screw provided with the servo using a #1 Phillips screwdriver. Attaching the horn using this method will give equal movement of the horn to both low throttle and full throttle.



### □ Step 14

Open the bag marked fuselage. Remove the clevis retainer and slide it onto the clevis from the bag. The clevis is then threaded 10 turns on the 16 1/2-inch (420mm) pushrod.

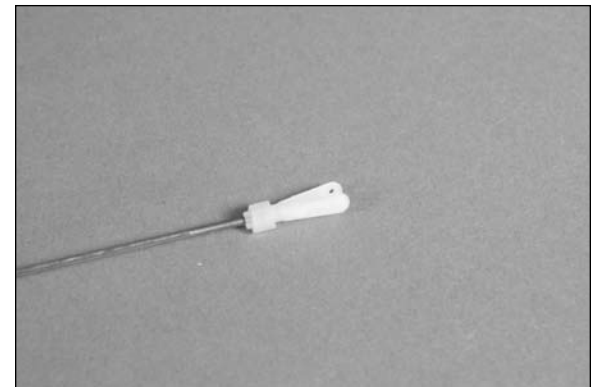

### □ Step 15

Slide the pushrod into the pushrod tube. Connect the clevis to the hole of the servo arm that is 1/2-inch (12mm) from the center of the servo horn. Use the radio system to move the throttle to the low position.

### □ Step 16

Physically move the carburetor to the closed position. Use a felt-tipped pen to mark the pushrod where it crosses the middle hole of the carburetor arm.

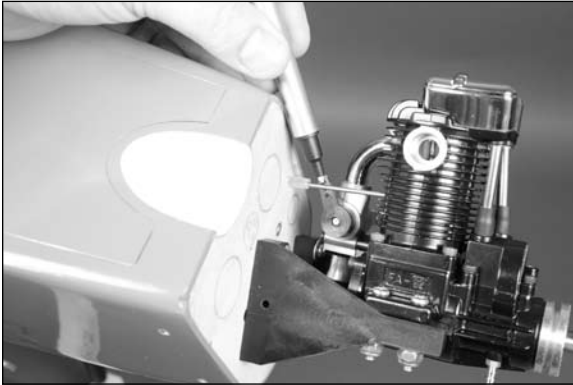

**Note:** Check to make sure the servo will move the carburetor in the correct directions before proceeding. In most cases, the servo arm will angle back for closed. Check to make sure that operating the carburetor linkage manually and the direction the servo operates in provides the correct results.

### □ Step 17

Make a Z-bend in the pushrod wire at the mark made in the previous step. Insert the bend through the middle hole in the carburetor arm and secure the pushrod to the servo horn using a pushrod keeper.

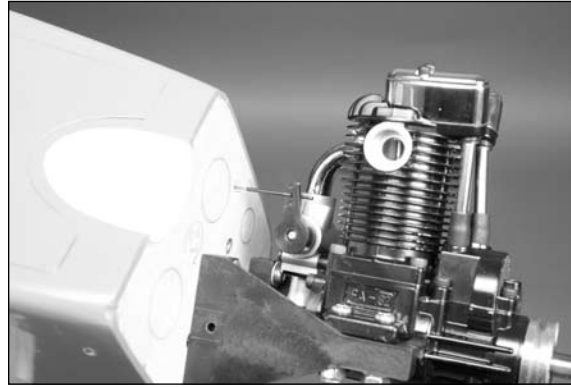

**Note:** You will need to remove the carburetor arm from the carburetor in most cases. Make sure the arm is secure and aligned correctly before proceeding with adjusting the radio system.

### □ Step 18

Check the operation of the carburetor and that it can move from open to closed using the radio system. You may need to use the end point adjustments in the radio programming to fine-tune the operation of the throttle.

### □ Step 19

Use medium CA to glue the throttle tube support to the fuselage side and to the throttle pushrod tube.



## Fuel Tank Installation

### Required Parts

Fuselage assembly	Fuel tank assembly
#4 washer	Tie-wrap
4-40 x 3/8-inch socket head screw	

### Tools and Adhesives

Side cutter  
Ball driver or hex wrench: 3/32-inch  
Hobby knife with #11 blade

### □ Step 1

Remove the hatch from the bottom of the fuselage. Magnets hold the rear of the hatch while tabs at the front key to the fuselage to keep it secure. The rear only need to be lifted slightly to remove the hatch, as lifting it too much may damage the tabs at the front.



### □ Step 2

Open the bag with the fuel tank. The plywood tray can be set aside as it is for the EP version and will not be used.

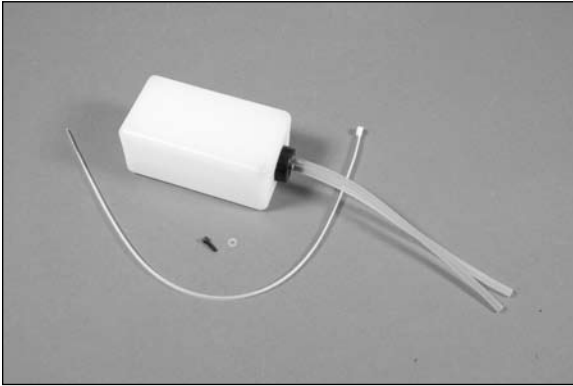

### □ Step 3

Position the tie-wrap in the fuselage as shown. Make sure the tie-wrap will not pull on the throttle tube and is positioned to the inside of the tube as shown.



### □ Step 4

Inspect the fuel tank to determine the position of the vent tube inside the tank. It is important to note which direction the vent line faces so the tank can be installed in the correct direction. Also note which fuel tubes go to the vent line and to the clunk so they can be connected to the engine correctly.

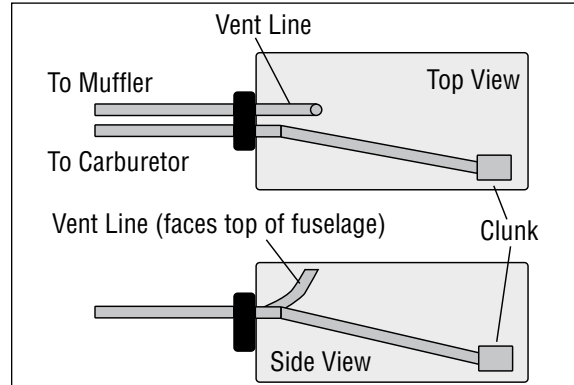

### □ Step 5

Insert the fuel tank into the fuselage while guiding the fuel tubes through the hole in the firewall. Make sure the vent line faces the top of the fuselage before using the tie-wrap to secure the position of the tank in the fuselage. Use side cutters to trim the excess tie-wrap so it will not interfere with the installation of the hatch on the bottom of the fuselage.

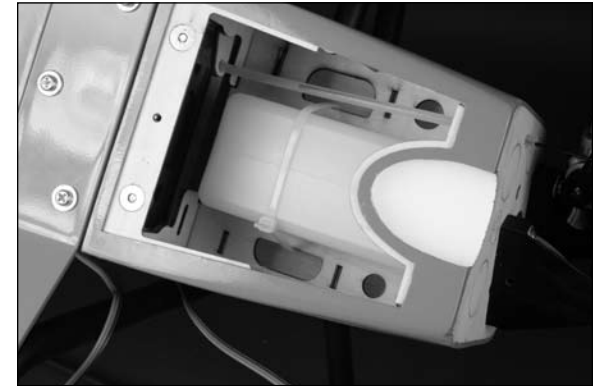
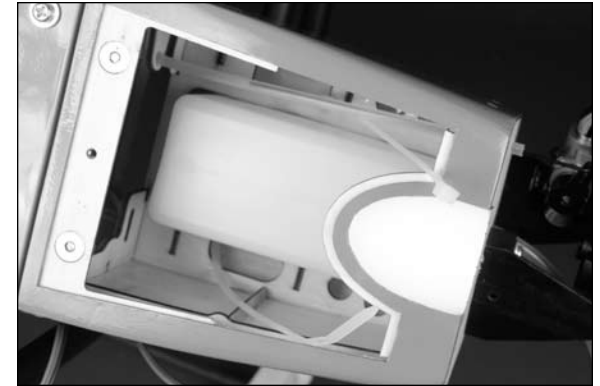

### □ Step 6

Use a hobby knife with a #11 blade to remove the covering from the screw hole at the rear of the fuselage hatch.

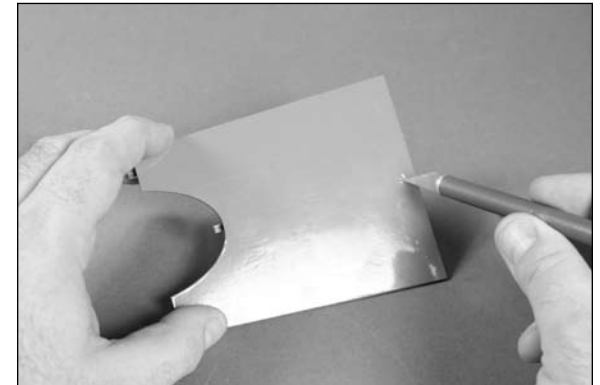

**Step 7**

Place the fuselage hatch back into position on the bottom of the fuselage. Use a 4-40 x 3/8-inch socket head screw and #4 washer to secure the hatch back on the fuselage. Use a 3/32-inch ball driver or hex wrench to tighten the screw.



**Step 8**

Install the muffler on the engine following the instructions provided with the engine. Connect the fuel line from the clunk to the carburetor and the vent line from the tank to the muffler.



## **Electric Motor Installation**

**Required Parts**

Fuselage assembly	Plywood battery tray
#8 washer (4)	Hook and loop strap
Tie-wrap (not included)	#4 washer (2)
4-40 x 3/8-inch socket head screw (2)	
1 <sup>15</sup> / <sub>16</sub> -inch (48mm) standoff (4)	
Hook and loop tape (not included)	
8-32 x 2 <sup>1</sup> / <sub>4</sub> -inch machine screw (4)	

**Tools and Adhesives**

Hobby knife with #11 blade	Drill
Phillips screwdriver: #2	
Drill bit: 5/32-inch (4mm)	
Ball driver or hex wrench: 3/32-inch	

**Step 1**

Locate the items to install the electric motor and speed control in the fuselage.

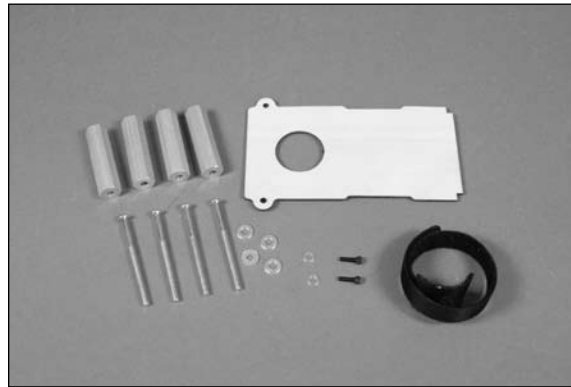

**Step 2**

Use hook and loop tape (not included) to secure the speed control to the plywood battery tray. The tray is symmetrical with no official top or bottom to the tray until the speed control is attached. The side with the speed control will now be considered the top of the tray.

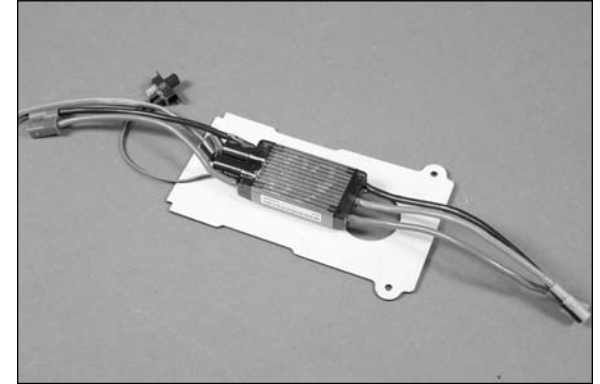

**Step 3**

Insert the hook and loop strap in the fuselage as shown.

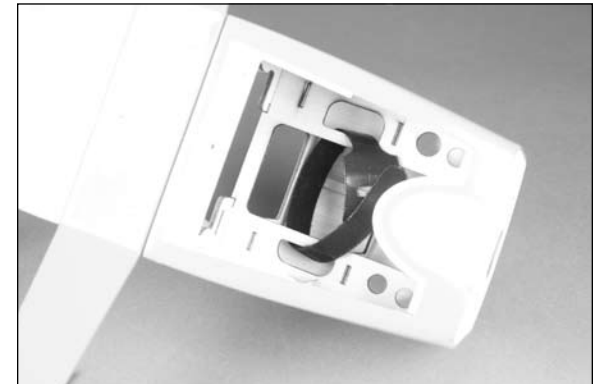

#### □ Step 4

Insert the battery tray in the fuselage with the speed control facing to the top of the fuselage. Make sure to guide the wires for the motor through the hole in the firewall and the wires for the battery and connection to the receiver are under the battery tray support. Slide the tray rearward so it keys into the former at the rear of the tray. The front of the tray is secured using two 4-40 x 3/8-inch socket head screws and two #4 washers. Use threadlock on the screws before tightening them using a 3/32-inch hex wrench or ball driver.

**Hint:** Use low-tack tape to keep the hook and loop strap out of the way while installing the battery tray.

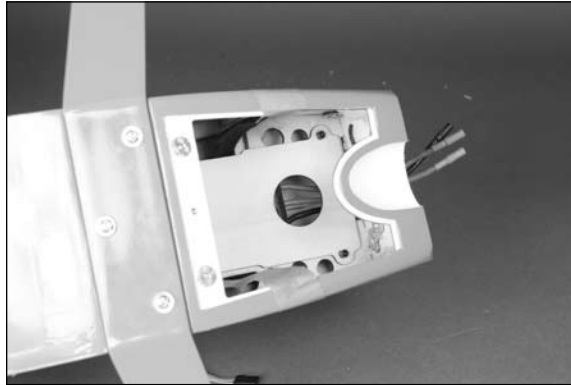
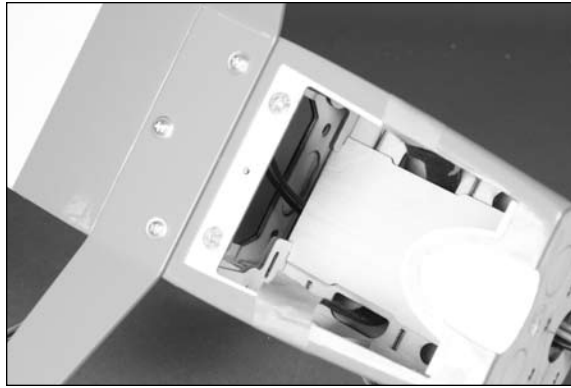
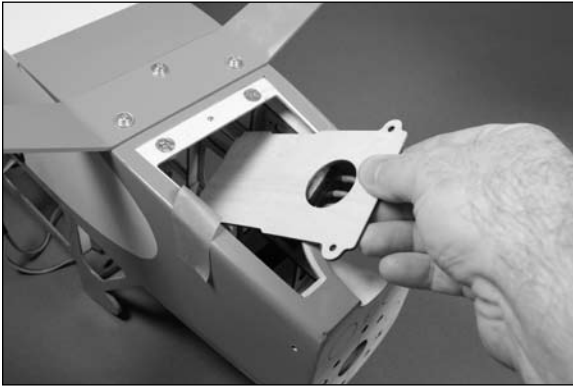

#### □ Step 5

Plug the speed control lead into the throttle channel of the receiver. Mount the switch from the E-Flite 60-amp ESC in the switch location on the side of the fuselage in the battery compartment.

#### □ Step 6

Secure the battery in the fuselage using the hook and loop strap. It is suggested to use a piece of hook and loop material (not included) between the battery and battery tray to keep the battery from sliding on the battery tray in flight.

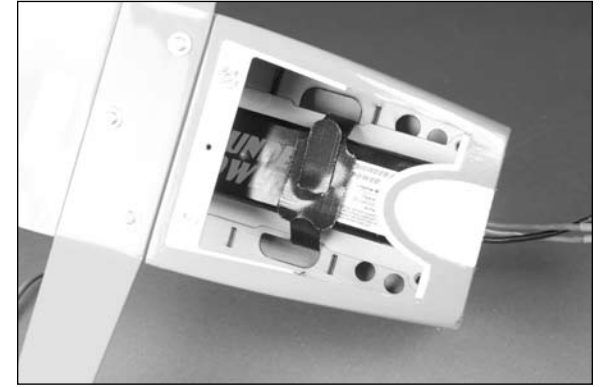

#### □ Step 7

Use a hobby knife and #11 blade to remove the covering from the fuselage hatch so it can be removed easily to access the battery. This will also provide an exit for air to escape after entering the fuselage.

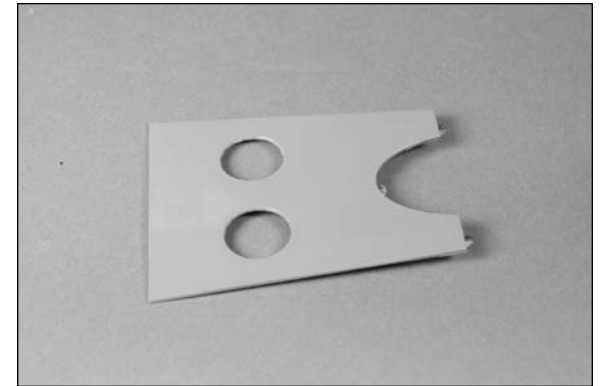

☐ Step 8

Place the fuselage hatch back onto the bottom of the fuselage.

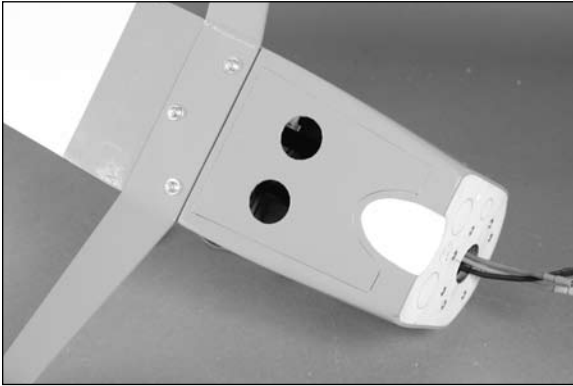

☐ Step 9

Use a hobby knife with a #11 blade to remove the three plugs in the firewall to allow air to pass into the fuselage.

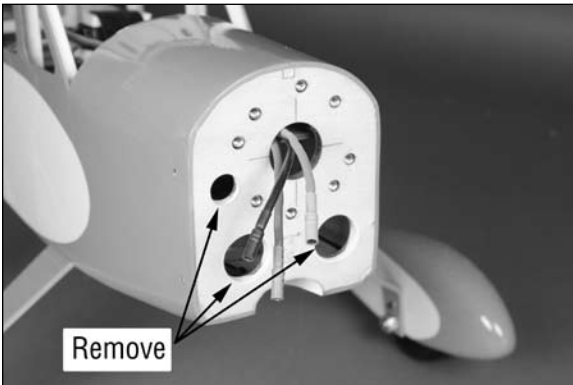

☐ Step 10

Use a drill and 5/32-inch drill bit to enlarge the outer holes on the motor mount. Make sure to hold the mount securely when drilling as it can be easily removed from your hand and cause personal injury.

**Hint:** It is highly recommended to use a drill press for drilling the mount if one is available.

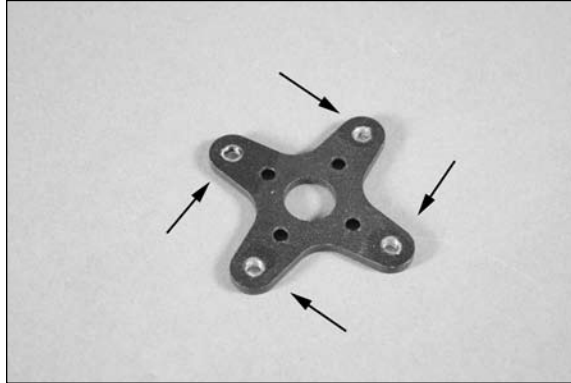

☐ Step 11

Secure the mount to the motor using the hardware provided with the motor. Use #2 Phillips screwdriver and threadlock to secure the screws.



☐ Step 12

Attach the motor to the firewall using four 8-32 x 2-1/4-inch machine screws, four 1-15/16- (48mm) standoffs and four #8 washers. Use threadlock on the screws to prevent them from vibrating loose.

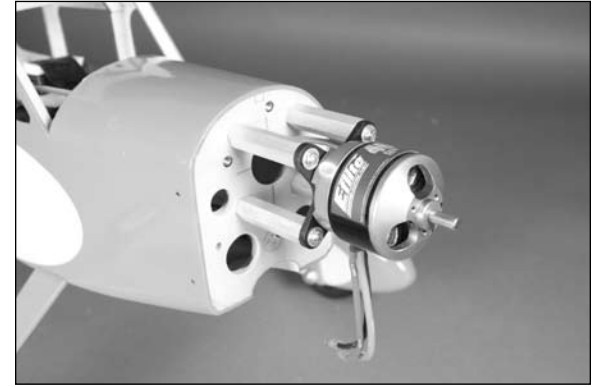

☐ Step 13

Connect the leads from the motor to the leads from the speed control. Use the radio system to operate the motor and check its rotation. When viewed from the front of the fuselage the motor will rotate counterclockwise. If not, follow the instructions provided with the speed controller to correct the direction of rotation. Use a tie-wrap (not included) to secure the motor leads so they will not interfere with the operation of the motor.



## Cowling Installation

### Required Parts

Fuselage assembly	#4 washer (4)
Painted cowling	Clear cowling template
Spinner	Spinner backplate
Fuel tubing, 1/4-inch (6mm) (4)	
#4 x 1/2-inch sheet metal screw (2)	
4-40 x 1/2-inch socket head screw (4)	

### Tools and Adhesives

Hobby scissors	Phillips screwdriver: #1
Metric propeller reamer	
Rotary tool with sanding drum	
Ball driver or hex wrench: 3/32-inch	

#### Step 1

Locate the items necessary to install the cowling and spinner. You will also need the painted cowling and clear cowling as well.

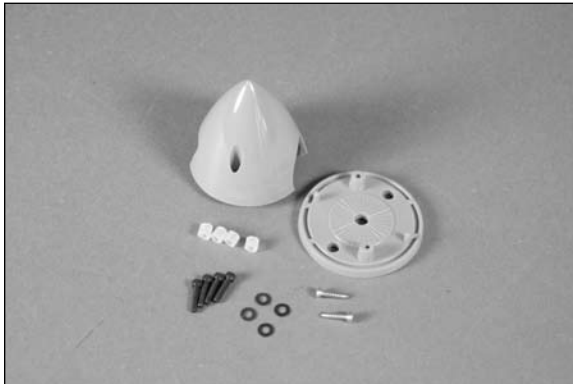

**Note:** If you are using an electric motor, you can skip directly to Step 6 and mount the cowl as there is no cutting necessary for an electric motor.

#### Step 2

Use cardstock to make template indicating the needle valve, engine head and muffler, as well as any other items that may protrude through the cowling.



#### Step 3

Remove the engine from the firewall and position the clear cowling on the front of the fuselage. Use the templates and a felt-tipped pen to transfer the locations to the clear cowling.

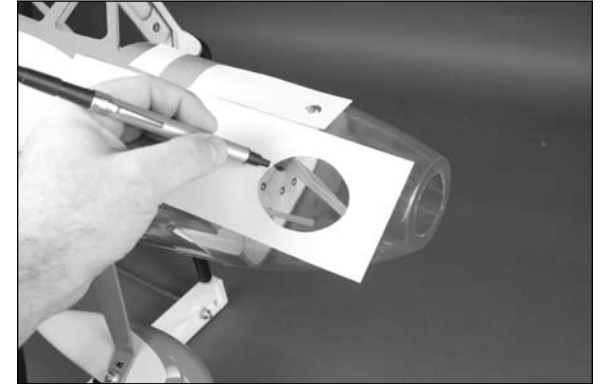

#### Step 4

Install the engine back on the fuselage. Check the fit of the clear cowling over the engine and make any necessary adjustments to the clear cowling fits without hitting any of the engine components.

#### Step 5

After the clear cowl has been trimmed and fit, you can slide it over the painted cowl and transfer the outlines to the painted cowl. Check the fit of the painted cowling on the fuselage.



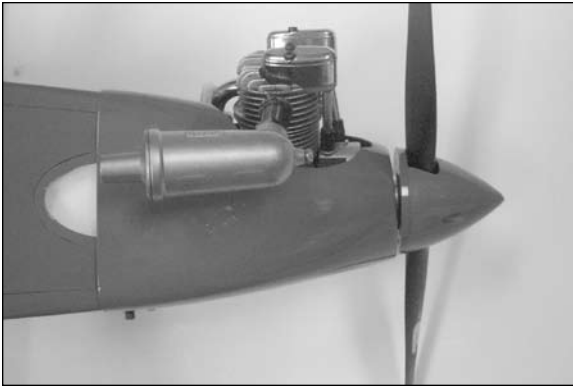

**Step 6**

Prepare the four 4-40 x 1/2-inch socket head screws for installation by sliding a #4 washer and a piece of 1/4-inch (6mm) fuel tubing on each screw as shown.



**Step 7**

Use the screws prepared in the previous step and a 3/32-inch ball driver or hex wrench to attach the cowl to the fuselage.

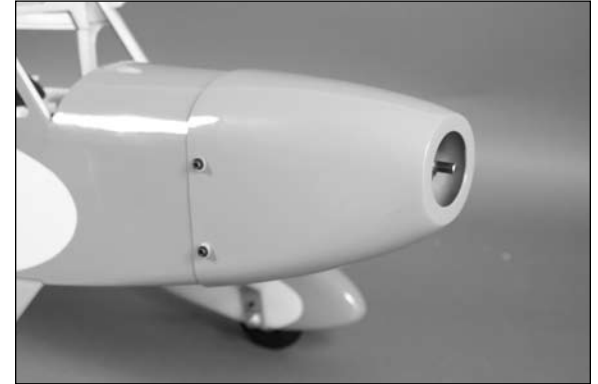

**Step 8**

Slide the spinner backplate onto the shaft of your motor. It may be necessary to use a reamer to enlarge the hole in the spinner to fit your shaft.

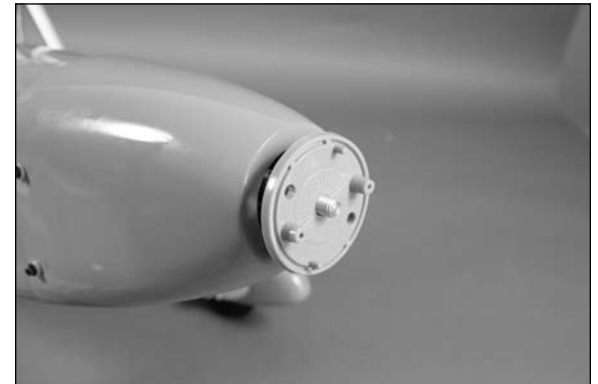

**Note:** If you are using an electric motor, you will need to install the propeller adapter first. Follow the instructions included with the motor for the installation procedure for the adapter.

**Note:** It may be necessary to enlarge the hole in the spinner backplate to fit your motor or engine. Use a metric propeller reamer for this job.



**Step 9**

Slide the propeller on the motor shaft. Align the propeller so it almost touches the two small pegs that protrude from the spinner backplate.



**Step 10**

Use the propeller nut (and washer) to secure the propeller and spinner backplate. Make sure to use a box wrench when tightening the propeller nut on a glow engine. Using pliers or an adjustable wrench may slip and damage the nut.



**Step 11**

Slide the spinner cone into position on the spinner backplate. It will key into the grooves of the backplate. Make sure that the propeller does not touch the spinner cone. If it does, remove the cone and reposition the propeller in relation to the backplate. Once the propeller is positioned, use two #4 x 1/2-inch sheet metal screws and a #1 Phillips screwdriver to secure the spinner cone to the backplate.

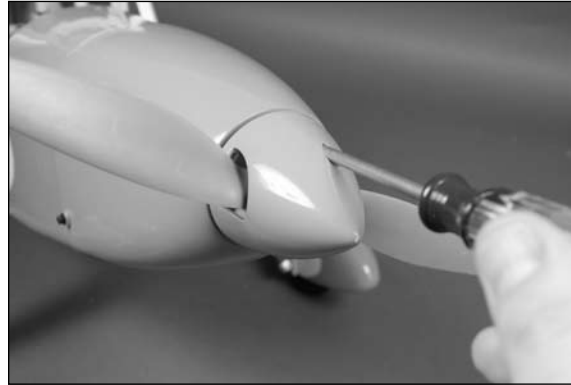

## **Window Installation**

### **Required Parts**

Fuselage assembly	Windshield
Center window (2)	
Rear window (right and left)	
Forward window (right and left)	

### **Tools and Adhesives**

Low-tack tape	Canopy glue
---------------	-------------

**Step 1**

Locate the windows and windshield as listed in the parts. All the windows are pre-trimmed and ready to mount in the fuselage. The only thing that will take time is allowing for the glue to cure.

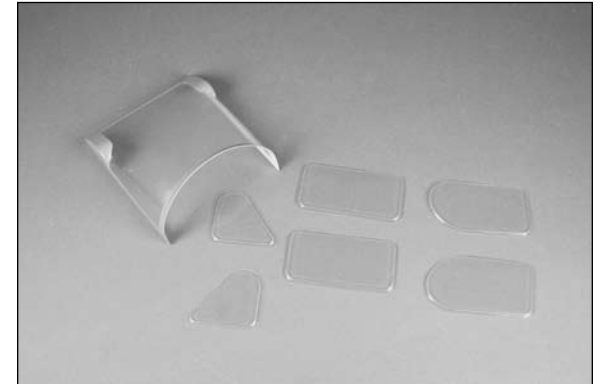

## Step 2

Check the fit of the windows in the sides of the fuselage. The windows fit on the inside of the fuselage to hide the edges. Once the right and left windows have been determined, use canopy glue to glue the windows in the fuselage sides. Use low-tack tape to keep the windows in position until the glue cures.

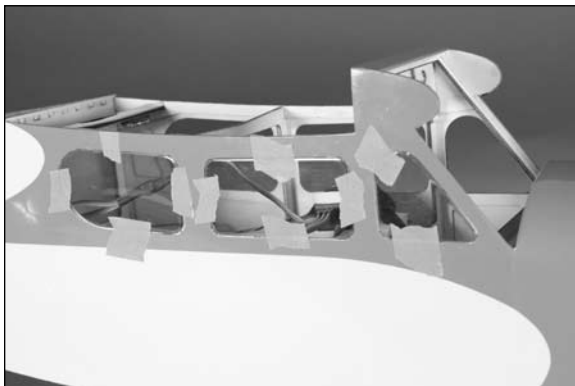

## Step 3

The windshield is installed in the same manner as the side windows. Once everything has been placed, set the fuselage aside to allow the glue to fully cure.

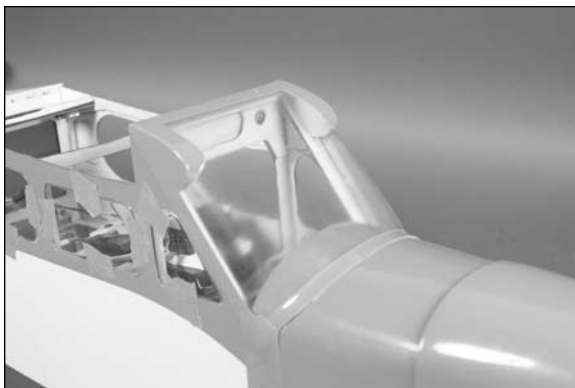

## **Aileron Servo Installation**

### **Required Parts**

Wing panel (right and left)	Clevis (2)
Clevis retainer (2)	Pushrod keeper (2)
Servo with hardware (2)	
9-inch (228mm) servo extension (2)	
Aileron servo mounting blocks (4)	
27/8-inch (73mm) pushrod wire (2)	
#4 x 1/2-inch sheet metal screw (8)	

### **Tools and Adhesives**

Phillips screwdriver: #1	30-minute epoxy
Mixing sticks	Mixing cup
Drill	Pencil
Ruler	Thin CA
Small clamps	Medium grit sandpaper
Drill bit: 1/16-inch (1.5mm), 5/64-inch (2mm)	

## Step 1

Locate the items necessary to install the aileron servos in the wing. Most items are from the bag marked wing. You will also need the aileron pushrod wires from the bag marked pushrod.

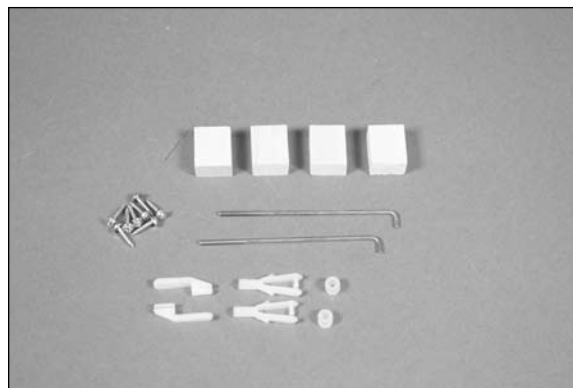

## Step 2

Remove the servo cover for the aileron from the wing panel. Note the location of the servo horn exit on the cover and how it aligns with the control horn.



## Step 3

Prepare a 180-degree servo horn by removing one of the arms from the horn as show. Use a pin drill and 5/64-inch (2mm) drill bit to enlarge the outer hole that is 9/16-inch (15mm) from the center of the arm.

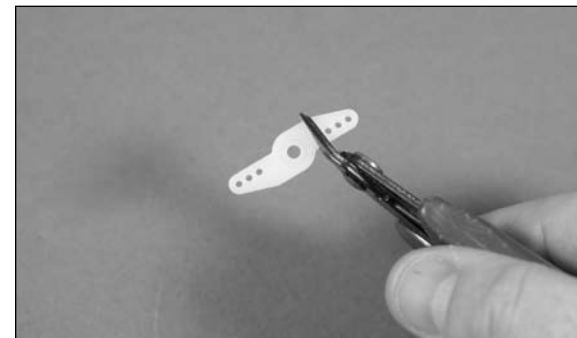

#### □□ Step 4

Install the rubber grommets and brass eyelets in the servo according to the instructions provided with your servo or radio instruction manual. Use the radio system to center the aileron servo. After removing the stock servo arm, install the 180-degree servo horn that was prepared in the previous step. Note the direction of the arm in relationship to the servo and servo cover.

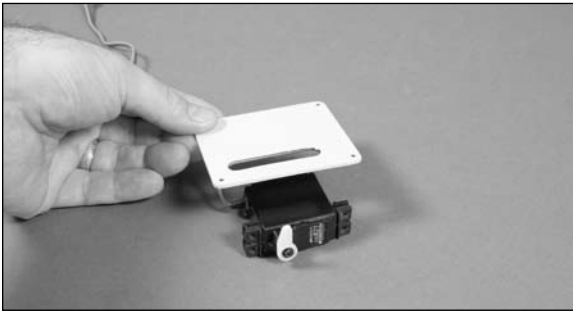

#### □□ Step 5

With the arm centered in the opening in the servo cover, use a pencil to transfer the location of the servo on the cover.

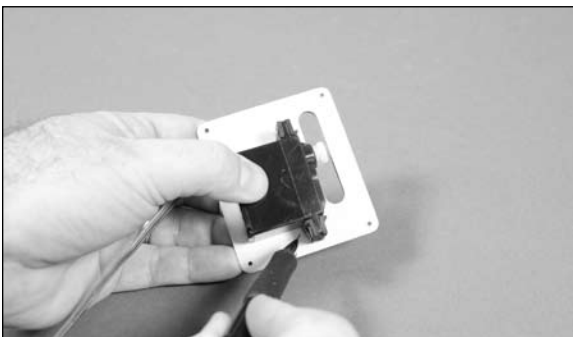

#### □□ Step 6

Use medium grit sandpaper to roughen the servo mounting block where it will fit against the servo cover. This will improve the surface for bonding the epoxy in the following step. Make sure to sand the end grain of the blocks.



#### □□ Step 7

Use 30-minute epoxy to glue the blocks to the servo cover at the marks made earlier. Use clamps or tape to keep the block tight against the servo cover until the epoxy fully cures.

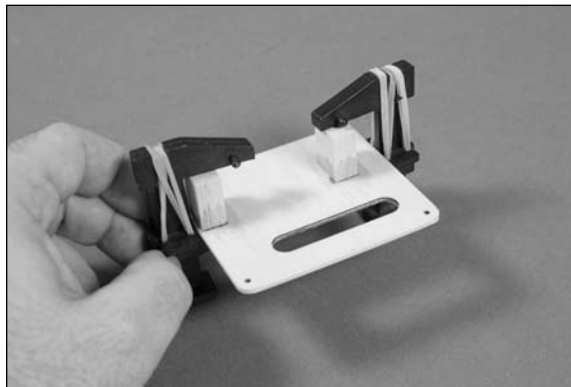

**Important:** Make sure the blocks are at least 1/16-inch (1.5mm) from the edge of the servo cover. If not, the cover may not fit back onto the wing as the blocks will interfere with the fit.

#### □□ Step 8

Position the servo on the servo cover. Leave a small gap of 1/32-inch (1mm) between the servo and cover so vibration won't be transferred through the cover and into the servo. Use a pencil to mark the locations for the four servo mounting screws.

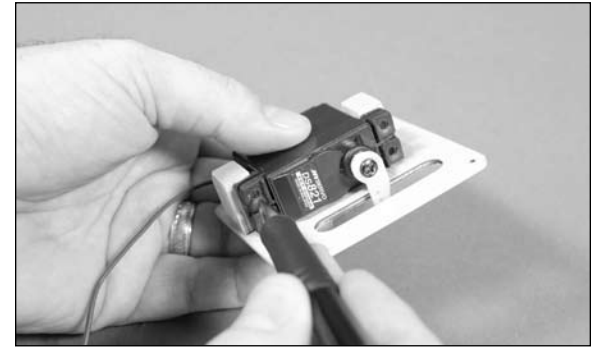

#### □□ Step 9

Use a drill and 1/16-inch (1.5mm) drill bit to drill the four holes on the blocks for the servo mounting screws. Place 2 to 3 drops of thin CA in each hole to harden the surrounding wood.

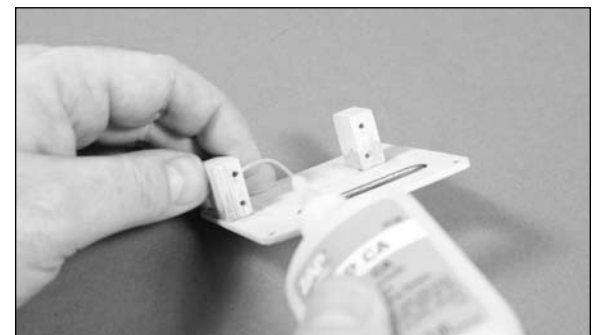
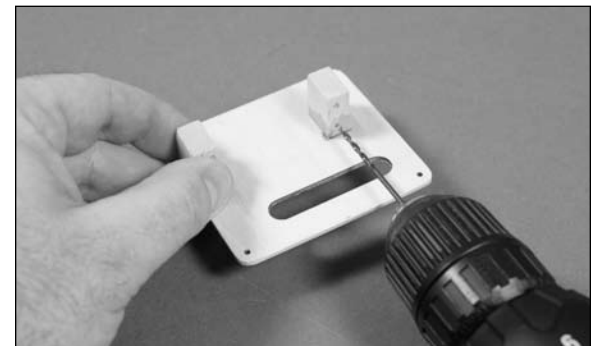

□□ Step 10

Use a #1 Phillips screwdriver and the screws provided with the servo to secure the servo to the mounting blocks.

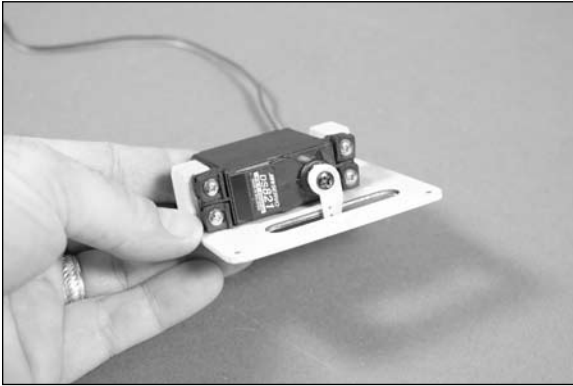

□□ Step 11

Secure a 9-inch (228mm) servo extension to the aileron servo lead. Use string or a commercially available connector to keep the connection from unplugging accidentally inside the wing.

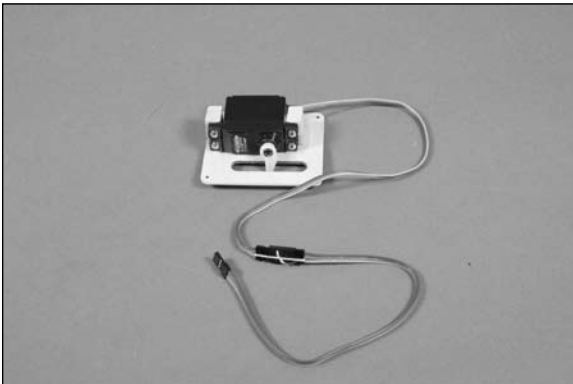

□□ Step 12

Apply 2 to 3 drops of thin CA into each of the holes for the servo mounting cover screws to harden the surrounding wood.



□□ Step 13

Remove the tape that secures the string inside the opening for the aileron servo. Tie the string around the end of the extension. Use the string to pull the aileron servo extension into the opening at the center of the wing as shown.

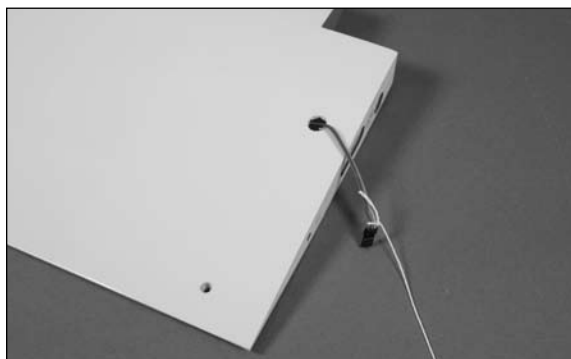
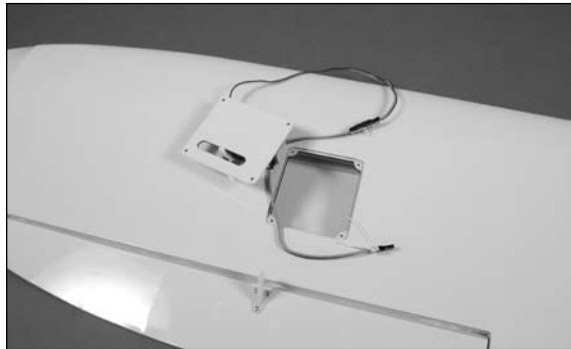

□□ Step 14

Use four #4 x 1/2-inch sheet metal screws and a #1 Phillips screwdriver to secure the servo cover to the wing.



□□ Step 15

Insert the bend from the 2<sup>7</sup>/<sub>8</sub>-inch pushrod wire into the hole drilled in the aileron servo horn. Use a pushrod connector to secure the wire to the horn.

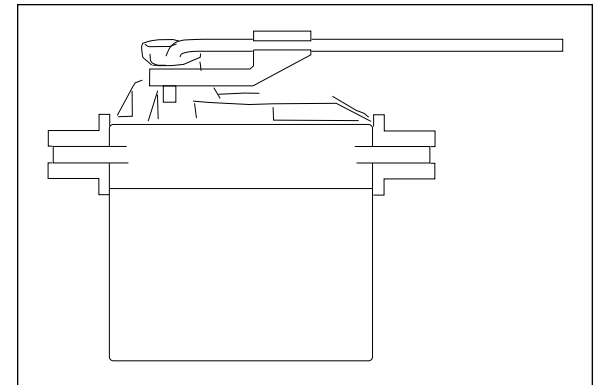

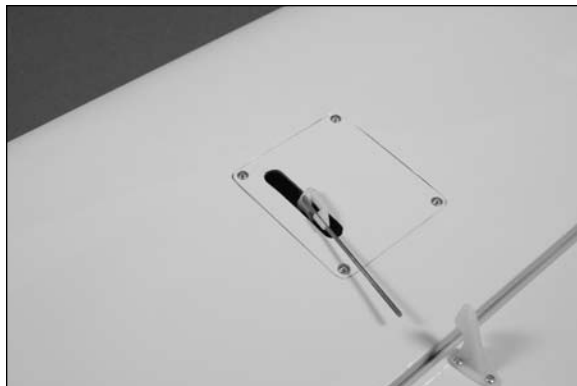

**Step 16**

Slide a clevis retainer on a clevis, then thread the clevis on the pushrod wire. With the radio system on to keep the aileron servo centered, thread the clevis in or out so the aileron aligns with the trailing edge of the wing. Connect the clevis to the center hole of the aileron control horn then slide the clevis retainer on the clevis to keep it secure.



**Step 17**

Repeat Steps 1 through 16 to install the aileron servo in the opposite wing panel.

## Wing Installation

### Required Parts

- Wing bolt plate
- Fuselage assembly
- Nylon wing bolt (2)
- Wing panel assembly (right and left)
- Anodized aluminum wing tube
- Anodized aluminum anti-rotation tube

**Step 1**

Locate the items necessary to mount the wing to the fuselage. Most items are in the bag marked wing. The wing tubes are unmarked, but the bag contains only the anodized wing tube and the anodized anti-rotation tube. A small flat screwdriver can be used to remove obstructions.

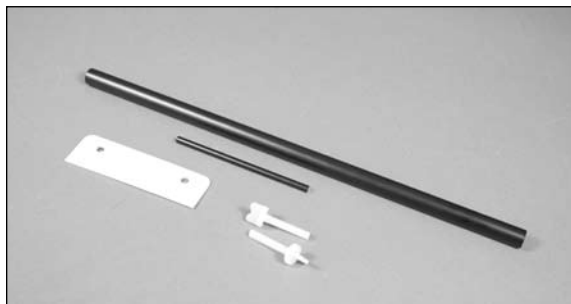

**Step 2**

Slide the anodized wing tube and the anodized anti-rotation tube into one of the wing panels. The tubes will slide in easily. If not, look for obstructions in the wing tube.

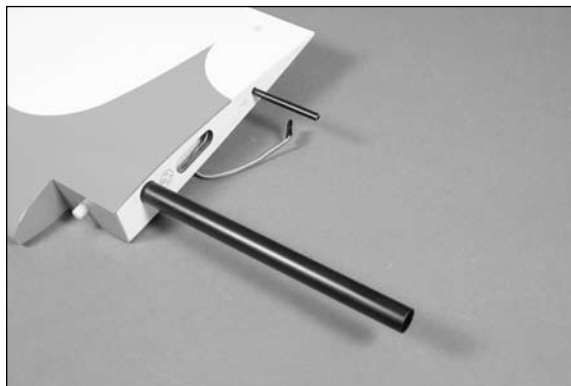

**Step 3**

Slide the remaining wing panel on the tubes. The two wing panels will fit tightly together.

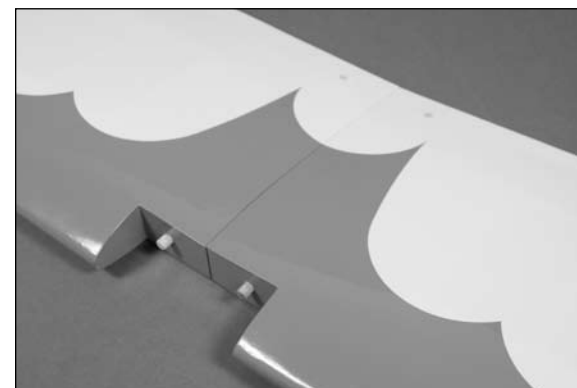

**Step 4**

Position the wing over the fuselage. Plug the servo extensions from the aileron servos into the Y-harness or servo extensions that were plugged into the receiver when it was installed earlier.



**Step 5**

Slide the wing forward so the wing dowels go into the holes in the fuselage.

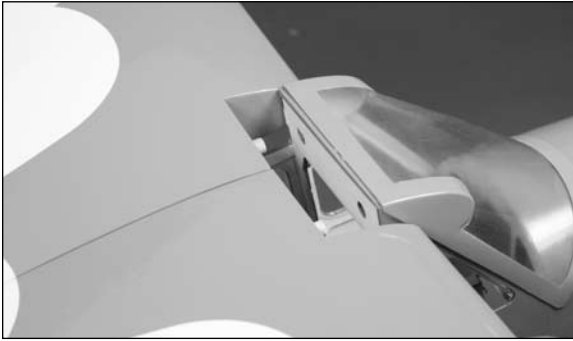

**Step 6**

Position the wing bolt plate over the holes at the rear of the wing. The nylon wing bolts will go through the wing bolt plate, through the wing and thread into the blind nuts that have been installed in the fuselage. Tighten the nylon bolts to secure the wing to the fuselage.

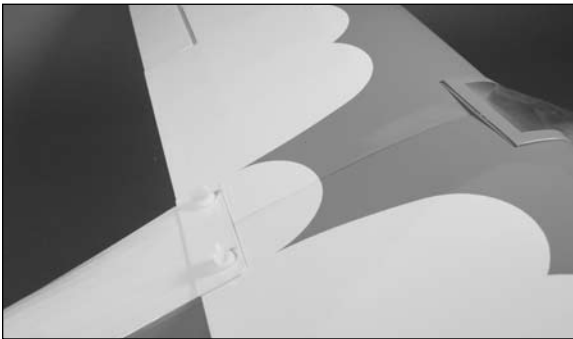
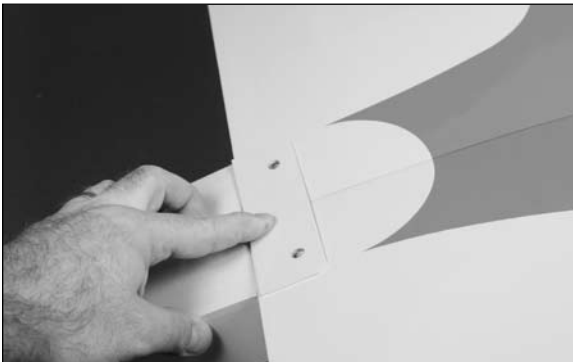

## Center of Gravity

An important part of preparing the aircraft for flight is properly balancing the model.

**Caution: Do not inadvertently skip this step!**

The recommended Center of Gravity (CG) location for your model is  $2\frac{3}{4}$ -inch (70mm) back, or 25% of the chord, from the leading edge of the wing. Mark the location for the Center of Gravity on the bottom of the wing next to the fuselage as shown. The CG range for your model is  $2\frac{1}{2}$  to 3 inches (64mm to 76mm) from the leading edge of the wing.

When balancing your model, support the plane upright at the marks made on the bottom of the wing with your fingers or a commercially available balancing stand. This is the correct balance point for your model. You might find you may be required to add a small amount of weight to either the front or back of the fuselage to achieve the correct balance.

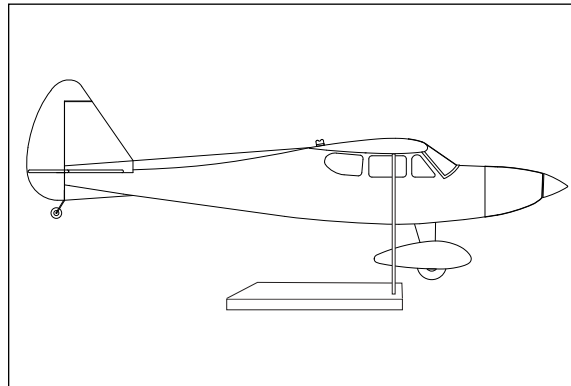
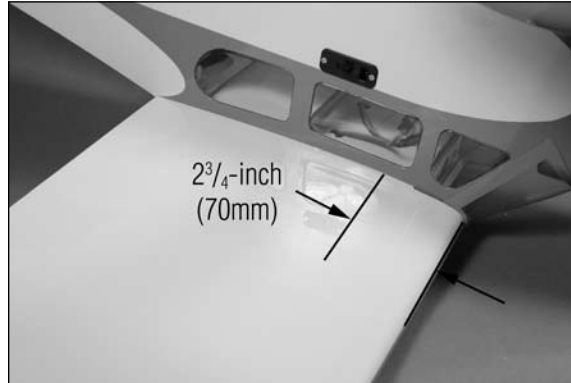

After the first flights, the CG position can be adjusted for your personal preference.

## Control Throws

**Step 1**

Turn on the transmitter and receiver of your model. Check the movement of the rudder using the transmitter. When the stick is moved right, the rudder should also move right. Reverse the direction of the servo at the transmitter if necessary.

**Step 2**

Check the movement of the elevator with the radio system. Moving the elevator stick toward the bottom of the transmitter will make the airplane elevator move up.

**Step 3**

Check the movement of the ailerons with the radio system. Moving the aileron stick right will make the right aileron move up and the left aileron move down.

**Step 4**

Use a ruler to adjust the throw of the elevator, ailerons and rudder.

### Aileron High Rate

Up	1-inch	(25mm)	23 Degrees
Down	1-inch	(25mm)	23 Degrees

### Aileron Low Rate

Up	5/8-inch	(16mm)	14 Degrees
Down	5/8-inch	(16mm)	14 Degrees

### Elevator High Rate

Up	1 <sup>3</sup> / <sub>8</sub> -inch	(35mm)	21 Degrees
Down	1 <sup>3</sup> / <sub>8</sub> -inch	(35mm)	21 Degrees

### Elevator Low Rate

Up	7/8-inch	(22mm)	14 Degrees
Down	7/8-inch	(22mm)	14 Degrees

### Rudder High Rate

Left	1 <sup>1</sup> / <sub>2</sub> -inch	(38mm)	25 Degrees
Right	1 <sup>1</sup> / <sub>2</sub> -inch	(38mm)	25 Degrees

### Rudder Low Rate

Left	1-inch	(25mm)	17 Degrees
Right	1-inch	(25mm)	17 Degrees

**Note:** Measurements are taken at the widest point on the control surface.

These are general guidelines measured from our own flight tests. You can experiment with higher or lower rates to match your preferred style of flying.

**Note:** Travel Adjust, Sub Trim and Dual Rates are not listed and should be adjusted according to each individual model and preference.

## Flight Preparations

Flight preparations must be checked each time you travel to the flying field. Because your model will encounter a variety of situations, it is best to keep an eye on the various components of your model to keep it in the best flying condition.

### Checking the Frequency

When using a Spektrum radio system, follow the guidelines for use of DSM radio systems at your particular field.

### Checking the Controls

Before starting your engine, check to make sure the controls are operating in the correct directions and the linkages and surfaces are not binding anywhere. Also look at the clevises and clevis retainers to make sure they are secure and will not come loose or fail in flight.

### Fueling your Model

Fill the fuel tank with the proper fuel. Fill the tank by connecting the fuel pump to the line going to the needle valve or to the fuel dot on the side of the cowling. Disconnect the fuel line attached to the pressure fitting of the muffler; your tank is full when fuel begins to run out of the pressure line. Reconnect the fuel lines to the needle valve assembly or insert the plug into the fuel dot and connect the line to the muffler.

**Note:** It is very important to reconnect the lines to the correct place. If they are reconnected incorrectly, the engine will not run properly.

## Maintaining Your Model

The following is a check list that you should follow every time you have completed a flying session with your model. Doing so will keep your aircraft in the best flying condition.

### Clean Up

After a long flying session with your model, you will want to clean it up before loading it into your vehicle to head home. Use a cleaner and a paper towel to wipe down the exterior of your plane, removing the fuel residue. Remember, a clean plane will last longer since the fuel won't be allowed to soak into any exposed wood.

### Checking the Propeller

Check to make sure the propeller is tightly secured to the engine. If not, remove the spinner and use a crescent wrench to tighten it back down. If you have had any not so great landings, you will want to inspect the propeller for any damage. Small nicks and scratches can quickly become fractures, causing the propeller to be unsafe for flight. Always carry a few spare propellers so a damaged propeller can be replaced at the field, increasing your flying time.

### Checking the Clevises

Inspect the aileron, elevator and rudder clevises to make sure they are connected and in good working order. If you find a clevis that is showing signs of wear or is broken, replace it with a new clevis. Also check the nylon connectors at the servo for any wear or damage. If they look worn or in bad shape, replace them as well.

### Checking the Control Horns

Inspect the control horns to make sure they have not crushed the wood of the control surface. If so, remove the control horn screws to remove the control horn. Place 2–3 drops of thin CA into each of the screw holes. In addition, use a T-pin to poke small holes in the covering in the area where the control horn mounts, then saturate the area with thin CA. This will harden the wood and give the control horns a solid surface to be mounted to.

### Checking the Wheel Collars

Check the setscrews on the wheel collars for the main and tail wheel to make sure they are not loose. Use a 1.5mm hex wrench to tighten the setscrews. It is suggested if they loosen frequently to remove them, apply threadlock to the setscrews, then secure the wheel collars back into position. The threadlock and hex wrench are included in the kit for this purpose.

### Check the Muffler Bolts

Use a 2.5mm hex wrench (Evolution 2-stroke) or box wrench (Saito 4-stroke) to make sure the hardware holding the muffler onto the engine is tight and has not vibrated loose during flight.

### Check the Engine Mount Bolts

Remove the spinner and propeller from the engine. Remove the exhaust stacks from the fuselage, and then remove the cowling from the fuselage. Remove the muffler from the engine, and then use a Phillips screwdriver to make sure the four bolts securing the engine to the mount are tight.

## Safety Do's and Don'ts for Pilots

- Ensure that your batteries have been properly charged prior to your initial flight.
- Keep track of the time the system is turned on so you will know how long you can safely operate your system.
- Perform a ground range check prior to the initial flight of the day. See the “Daily Flight Checks Section” for information.
- Check all control surfaces prior to each takeoff.
- Do not fly your model near spectators, parking areas or any other area that could result in injury to people or damage of property.
- Do not fly during adverse weather conditions. Poor visibility can cause disorientation and loss of control of your aircraft. Strong winds can cause similar problems.
- Do not point the transmitter antenna directly toward the model. The radiation pattern from the tip of the antenna is inherently low.
- Do not take chances. If at any time during flight you observe any erratic or abnormal operation, land immediately and do not resume flight until the cause of the problem has been ascertained and corrected. Safety can never be taken lightly.

## Dual Rate Recommendations

- We recommend that the rudder dual rate be set to Low for takeoff to help minimize overcorrection during the takeoff roll.
- We recommend the rudder dual rate be set to High for landing to help maintain heading as the model transitions from flying speed to taxi speeds.
- Elevator and Aileron dual rates should be adjusted for personal feel and also if there is any unusual wind conditions.

## Daily Flight Checks

### Step 1

Check the battery voltage on both the transmitter and the receiver battery packs. Do not fly below 4.3V on the transmitter if you are using a Spektrum transmitter that uses 4-cells to power the transmitter. Do not fly below 9.5V on the transmitter if you are using a JR or Spektrum transmitter that uses 8-cells to power the transmitter. Do not fly if the receiver pack is at or below 4.7V. To do so can crash your aircraft.

**Note:** When you check these batteries, ensure that you have the polarities correct on your expanded scale voltmeter.

### Step 2

Check all hardware (linkages, screws, nuts, and bolts) prior to each day's flight. Be sure that binding does not occur and that all parts are properly secured.

### Step 3

Ensure that all surfaces are moving in the proper manner.

### Step 4

Perform a ground range check before each day's flying session.

### Step 5

Prior to starting your aircraft, turn off your transmitter, then turn it back on. Do this each time you start your aircraft. If any critical switches are on without your knowledge, the transmitter alarm will warn you at this time.

### Step 6

Check that all trim levers are in the proper location.

### Step 7

All servo pigtailed and switch harness plugs should be secured in the receiver. Make sure that the switch harness moves freely in both directions.



## Age requirements

Age Recommendation: 14 years or over. This is not a toy. This product is not intended for use by children without direct adult supervision.

## Safety, Precautions and Warnings

As the user of this product, you are solely responsible for operating it in a manner that does not endanger yourself and others or result in damage to the product or the property of others.

Carefully follow the directions and warnings for this and any optional support equipment (chargers, rechargeable battery packs, etc.) that you use.

This model is controlled by a radio signal that is subject to interference from many sources outside your control. This interference can cause momentary loss of control so it is necessary to always keep a safe distance in all directions around your model, as this margin will help to avoid collisions or injury.

- Always operate your model in an open area away from cars, traffic or people.
- Avoid operating your model in the street where injury or damage can occur.
- Never operate the model out into the street or populated areas for any reason.
- Never operate your model with low transmitter batteries.
- Carefully follow the directions and warnings for this and any optional support equipment (chargers, rechargeable battery packs, etc.) that you use.
- Keep all chemicals, small parts and anything electrical out of the reach of children.
- Moisture causes damage to electronics. Avoid water exposure to all equipment not specifically designed and protected for this purpose.

## Warranty Information

### WARRANTY PERIOD

Exclusive Warranty- Horizon Hobby, Inc., (Horizon) warranties that the Products purchased (the "Product") will be free from defects in materials and workmanship at the date of purchase by the Purchaser.

### LIMITED WARRANTY

(a) This warranty is limited to the original Purchaser ("Purchaser") and is not transferable. REPAIR OR REPLACEMENT AS PROVIDED UNDER THIS WARRANTY IS THE EXCLUSIVE REMEDY OF THE PURCHASER. This warranty covers only those Products purchased from an authorized Horizon dealer. Third party transactions are not covered by this warranty. Proof of purchase is required for warranty claims. Further, Horizon reserves the right to change or modify this warranty without notice and disclaims all other warranties, express or implied.

(b) Limitations- HORIZON MAKES NO WARRANTY OR REPRESENTATION, EXPRESS OR IMPLIED, ABOUT NON-INFRINGEMENT, MERCHANTABILITY OR FITNESS FOR A PARTICULAR PURPOSE OF THE PRODUCT. THE PURCHASER ACKNOWLEDGES THAT THEY ALONE HAVE DETERMINED THAT THE PRODUCT WILL SUITABLY MEET THE REQUIREMENTS OF THE PURCHASER'S INTENDED USE.

(c) Purchaser Remedy- Horizon's sole obligation hereunder shall be that Horizon will, at its option, (i) repair or (ii) replace, any Product determined by Horizon to be defective. In the event of a defect, these are the Purchaser's exclusive remedies. Horizon reserves the right to inspect any and all equipment involved in a warranty claim. Repair or replacement decisions are at the sole discretion of Horizon. This warranty does not cover cosmetic damage or damage due to acts of God, accident, misuse, abuse, negligence, commercial use, or modification of or to any part of the Product. This warranty does not cover damage due to improper installation, operation, maintenance, or attempted repair by anyone other than Horizon. Return of any goods by Purchaser must be approved in writing by Horizon before shipment.

## DAMAGE LIMITS

HORIZON SHALL NOT BE LIABLE FOR SPECIAL, INDIRECT OR CONSEQUENTIAL DAMAGES, LOSS OF PROFITS OR PRODUCTION OR COMMERCIAL LOSS IN ANY WAY CONNECTED WITH THE PRODUCT, WHETHER SUCH CLAIM IS BASED IN CONTRACT, WARRANTY, NEGLIGENCE, OR STRICT LIABILITY. Further, in no event shall the liability of Horizon exceed the individual price of the Product on which liability is asserted. As Horizon has no control over use, setup, final assembly, modification or misuse, no liability shall be assumed nor accepted for any resulting damage or injury. By the act of use, setup or assembly, the user accepts all resulting liability.

If you as the Purchaser or user are not prepared to accept the liability associated with the use of this Product, you are advised to return this Product immediately in new and unused condition to the place of purchase.

Law: These Terms are governed by Illinois law (without regard to conflict of law principals).

## SAFETY PRECAUTIONS

This is a sophisticated hobby Product and not a toy. It must be operated with caution and common sense and requires some basic mechanical ability. Failure to operate this Product in a safe and responsible manner could result in injury or damage to the Product or other property. This Product is not intended for use by children without direct adult supervision. The Product manual contains instructions for safety, operation and maintenance. It is essential to read and follow all the instructions and warnings in the manual, prior to assembly, setup or use, in order to operate correctly and avoid damage or injury.

## QUESTIONS, ASSISTANCE, AND REPAIRS

Your local hobby store and/or place of purchase cannot provide warranty support or repair. Once assembly, setup or use of the Product has been started, you must contact Horizon directly. This will enable Horizon to better answer your questions and service you in the event that you may need any assistance. For questions or assistance, please direct your email to [productsupport@horizonhobby.com](mailto:productsupport@horizonhobby.com), or call 877.504.0233 toll free to speak to a service technician.

## INSPECTION OR REPAIRS

If this Product needs to be inspected or repaired, please call for a Return Merchandise Authorization (RMA). Pack the Product securely using a shipping carton. Please note that original boxes may be included, but are not designed to withstand the rigors of shipping without additional protection. Ship via a carrier that provides tracking and insurance for lost or damaged parcels, as Horizon is not responsible for merchandise until it arrives and is accepted at our facility. A Service Repair Request is available at [www.horizonhobby.com](http://www.horizonhobby.com) on the "Support" tab. If you do not have internet access, please include a letter with your complete name, street address, email address and phone number where you can be reached during business days, your RMA number, a list of the included items, method of payment for any non-warranty expenses and a brief summary of the problem. Your original sales receipt must also be included for warranty consideration. Be sure your name, address, and RMA number are clearly written on the outside of the shipping carton.

## WARRANTY INSPECTION AND REPAIRS

To receive warranty service, you must include your original sales receipt verifying the proof-of-purchase date. Provided warranty conditions have been met, your Product will be repaired or replaced free of charge. Repair or replacement decisions are at the sole discretion of Horizon Hobby.

## NON-WARRANTY REPAIRS

Should your repair not be covered by warranty the repair will be completed and payment will be required without notification or estimate of the expense unless the expense exceeds 50% of the retail purchase cost. By submitting the item for repair you are agreeing to payment of the repair without notification. Repair estimates are available upon request. You must include this request with your repair. Non-warranty repair estimates will be billed a minimum of 1/2 hour of labor. In addition you will be billed for return freight. Please advise us of your preferred method of payment. Horizon accepts money orders and cashiers checks, as well as Visa, MasterCard, American Express, and Discover cards. If you choose to pay by credit card, please include your credit card number and expiration date. Any repair left unpaid or unclaimed after 90 days will be considered abandoned and will be disposed of accordingly. Please note: non-warranty repair is only available on electronics and model engines.

### United States:

Electronics and engines requiring inspection or repair should be shipped to the following address:

Horizon Service Center  
4105 Fieldstone Road  
Champaign, Illinois 61822

All other Products requiring warranty inspection or repair should be shipped to the following address:

Horizon Product Support  
4105 Fieldstone Road  
Champaign, Illinois 61822

Please call 877-504-0233 or e-mail us at [productsupport@horizonhobby.com](mailto:productsupport@horizonhobby.com) with any questions or concerns regarding this product or warranty.

### United Kingdom:

Electronics and engines requiring inspection or repair should be shipped to the following address:

Horizon Hobby UK  
Units 1-4 Ployters Rd  
Staple Tye  
Harlow, Essex  
CM18 7NS  
United Kingdom

Please call +44 (0) 1279 641 097 or e-mail us at [sales@horizonhobby.co.uk](mailto:sales@horizonhobby.co.uk) with any questions or concerns regarding this product or warranty.

### Germany:

Electronics and engines requiring inspection or repair should be shipped to the following address:

Horizon Technischer Service  
Hamburger Strasse 10  
25335 Elmshorn  
Germany

Please call +49 4121 46199 66 or e-mail us at [service@horizonhobby.de](mailto:service@horizonhobby.de) with any questions or concerns regarding this product or warranty.

## CE Compliance Information for the European Union

### INSTRUCTIONS FOR DISPOSAL OF WEEE BY USERS IN THE EUROPEAN UNION

This product must not be disposed of with other waste. Instead, it is the user's responsibility to dispose of their waste equipment by handing it over to a designated collection point for the recycling of waste electrical and electronic equipment. The separate collection and recycling of your waste equipment at the time of disposal will help to conserve natural resources and ensure that it is recycled in a manner that protects human health and the environment. For more information about where you can drop off your waste equipment for recycling, please contact your local city office, your household waste disposal service or where you purchased the product.



## 2009 Official Academy of Model Aeronautics Safety Code

### GENERAL

1. A model aircraft shall be defined as a non-human-carrying device capable of sustained flight in the atmosphere. It shall not exceed limitations established in this code and is intended to be used exclusively for recreational or competition activity.
2. The maximum takeoff weight of a model aircraft, including fuel, is 55 pounds, except for those flown under the AMA Experimental Aircraft Rules.
3. I will abide by this Safety Code and all rules established for the flying site I use. I will not willfully fly my model aircraft in a reckless and/or dangerous manner.
4. I will not fly my model aircraft in sanctioned events, air shows, or model demonstrations until it has been proven airworthy.
5. I will not fly my model aircraft higher than approximately 400 feet above ground level, when within three (3) miles of an airport without notifying the airport operator. I will yield the right-of-way and avoid flying in the proximity of full-scale aircraft, utilizing a spotter when appropriate.
6. I will not fly my model aircraft unless it is identified with my name and address, or AMA number, inside or affixed to the outside of the model aircraft. This does not apply to model aircraft flown indoors.
7. I will not operate model aircraft with metal-blade propellers or with gaseous boosts (other than air), nor will I operate model aircraft with fuels containing tetranitromethane or hydrazine.
8. I will not operate model aircraft carrying pyrotechnic devices which explode burn, or propel a projectile of any kind. Exceptions include Free Flight fuses or devices that burn producing smoke and are securely attached to the model aircraft during flight. Rocket motors up to a G-series size may be used, provided they remain firmly attached to the model aircraft during flight. Model rockets may be flown in accordance with the National Model Rocketry Safety Code; however, they may not be launched from model aircraft. Officially designated AMA Air Show Teams (AST) are authorized to use devices and practices as defined within the Air Show Advisory Committee Document.

9. I will not operate my model aircraft while under the influence of alcohol or within eight (8) hours of having consumed alcohol.
10. I will not operate my model aircraft while using any drug which could adversely affect my ability to safely control my model aircraft.
11. Children under six (6) years old are only allowed on a flightline or in a flight area as a pilot or while under flight instruction.
12. When and where required by rule, helmets must be properly worn and fastened. They must be OSHA, DOT, ANSI, SNELL or NOCSAE approved or comply with comparable standards.

### RADIO CONTROL

1. All model flying shall be conducted in a manner to avoid over flight of unprotected people.
2. I will have completed a successful radio equipment ground-range check before the first flight of a new or repaired model aircraft.
3. I will not fly my model aircraft in the presence of spectators until I become a proficient flier, unless I am assisted by an experienced pilot.
4. At all flying sites a line must be established, in front of which all flying takes place. Only personnel associated with flying the model aircraft are allowed at or in front of the line. In the case of airshows demonstrations straight line must be established. An area away from the line must be maintained for spectators. Intentional flying behind the line is prohibited.
5. I will operate my model aircraft using only radio-control frequencies currently allowed by the Federal Communications Commission (FCC). Only individuals properly licensed by the FCC are authorized to operate equipment on Amateur Band frequencies.

6. I will not knowingly operate my model aircraft within three (3) miles of any preexisting flying site without a frequency-management agreement. A frequencymanagement agreement may be an allocation of frequencies for each site, a day-use agreement between sites, or testing which determines that no interference exists. A frequency-management agreement may exist between two or more AMA chartered clubs, AMA clubs and individual AMA members, or individual AMA members. Frequency-management agreements, including an interference test report if the agreement indicates no interference exists, will be signed by all parties and copies provided to AMA Headquarters.
7. With the exception of events flown under official AMA rules, no powered model may be flown outdoors closer than 25 feet to any individual, except for the pilot and located at the flightline.
8. Under no circumstances may a pilot or other person touch a model aircraft in flight while it is still under power, except to divert it from striking an individual.
9. Radio-controlled night flying is limited to low-performance model aircraft (less than 100 mph). The model aircraft must be equipped with a lighting system which clearly defines the aircraft's attitude and direction at all times.
10. The operator of a radio-controlled model aircraft shall control it during the entire flight, maintaining visual contact without enhancement other than by corrective lenses that are prescribed for the pilot. No model aircraft shall be equipped with devices which allow it to be flown to a selected location which is beyond the visual range of the pilot.



*Fly First Class™*



© 2009 Horizon Hobby, Inc.  
4105 Fieldstone Road  
Champaign, Illinois 61822  
(877) 504-0233  
[horizonhobby.com](http://horizonhobby.com)  
[Hangar-9.com](http://Hangar-9.com)