

BNF[™]
BASIC

UMX[™] BEAST[®] 3D

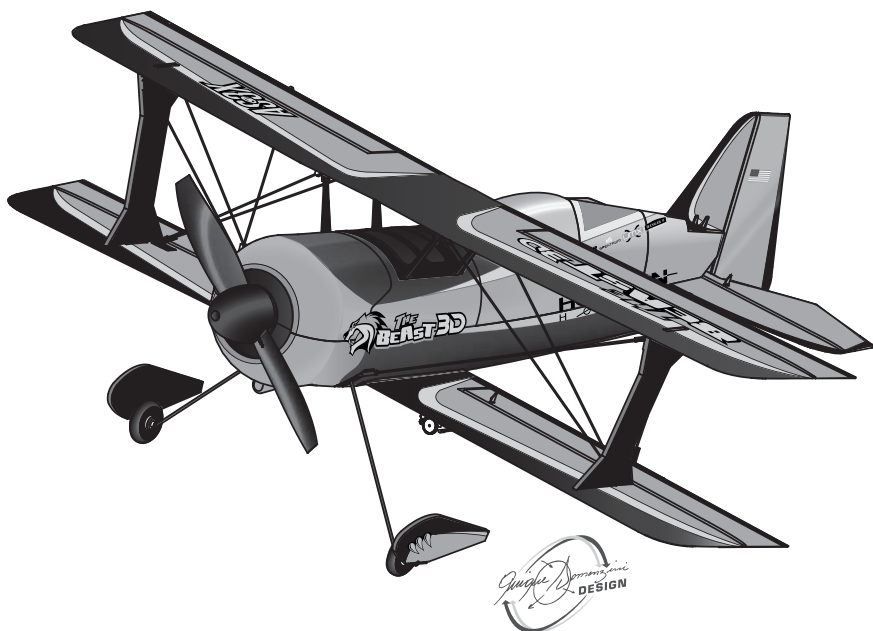

***Instruction Manual
Bedienungsanleitung
Manuel d'utilisation
Manuale di Istruzioni***

AS3X

E-flite[®]
ADVANCING ELECTRIC FLIGHT

NOTICE

All instructions, warranties and other collateral documents are subject to change at the sole discretion of Horizon Hobby, Inc. For up-to-date product literature, visit www.horizonhobby.com and click on the support tab for this product.

Meaning of Special Language

The following terms are used throughout the product literature to indicate various levels of potential harm when operating this product:

NOTICE: Procedures, which if not properly followed, create a possibility of physical property damage AND little or no possibility of injury.

CAUTION: Procedures, which if not properly followed, create the probability of physical property damage AND a possibility of serious injury.

WARNING: Procedures, which if not properly followed, create the probability of property damage, collateral damage, and serious injury OR create a high probability of superficial injury.

 **WARNING:** Read the ENTIRE instruction manual to become familiar with the features of the product before operating. Failure to operate the product correctly can result in damage to the product, personal property and cause serious injury.

This is a sophisticated hobby product. It must be operated with caution and common sense and requires some basic mechanical ability. Failure to operate this product in a safe and responsible manner could result in injury or damage to the product or other property. This product is not intended for use by children without direct adult supervision. Do not attempt disassembly, use with incompatible components or augment product in any way without the approval of Horizon Hobby, Inc. This manual contains instructions for safety, operation and maintenance. It is essential to read and follow all the instructions and warnings in the manual, prior to assembly, setup or use, in order to operate correctly and avoid damage or serious injury.

Age Recommendation: Not for children under 14 years. This is not a toy.

Designed by aerobatic world champion Quique Somenzini, the Ultra Micro extreme (UMX) Beast® 3D BNF Basic is a thrilling small-scale recreation of one of the most awe-inspiring airplanes ever created. At its heart is the revolutionary AS3X™ System built in to help provide you with a true 3D experience, the ability to fly indoors, and handle windy conditions outdoors. The added punch of its stronger 2500Kv, 180BL outrunner motor delivers an outstanding thrust to weight ratio. But beyond the capability to better perform all-out 3D, you will find that the Beast 3D with AS3X gives you unmatched precision in its size-class and remarkably stable handling. Surprisingly, all of the performance possible from the UMX™ Beast 3D BNF Basic only requires basic radio programming. And even though your new model is fully assembled, please read and follow this manual completely to be sure you're ready to take full advantage of what this awesome RC aircraft has to offer.

Table of Contents

Specifications	3	Flying Tips and Repairs	8
Preflight Checklist.....	4	Additional Safety Precautions and Warnings.....	9
AS3X™ Stabilization	4	Service of Power Components	10
Low Voltage Cutoff (LVC)	4	Troubleshooting Guide	11
Transmitter and Receiver Binding.....	5	Troubleshooting Guide (Continued).....	12
Installing the Flight Battery	5	Warranty and Repair Policy	13
Arming the ESC	6	Warranty and Service Information	14
Control Direction Test.....	6	Compliance Information for the European Union..	14
Control Centering	6	Parts Contact Information	54
Settings for Control Horns	7	Replacement Parts.....	54
Dual Rates	7	Optional Replacement Parts	55
Adjusting Center of Gravity (CG)	7		

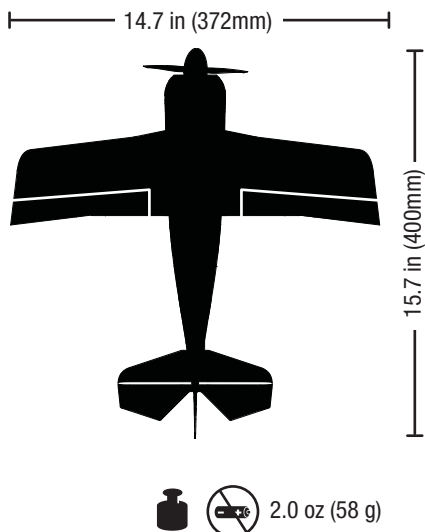

Specifications



Installed

-  EFLU4864 DSM2 6Ch Ultra Micro AS3X Receiver BL-ESC
-  BL180 Brushless Outrunner Motor, 2500Kv
-  (4) 2.3 g Performance Linear Long Throw Servo

Needed to Complete

-  **Battery:** 180mAh 2S 20C Li-Po
-  **Battery Charger:** 2S 7.4V Li-Po
-  **Recommended Transmitter:** Spektrum™ DSM2™/DSMX® full range with dual-rates (DX4e and up)

Preflight Checklist

✓	
	1. Charge flight battery.
	2. Install flight battery in the aircraft (once it has been fully charged).
	3. Bind aircraft to your transmitter.
	4. Make sure linkages move freely.
	5. Perform Control Direction Test with the transmitter.

✓	
	6. Adjust flight controls and transmitter.
	7. Perform a radio system Range Check.
	8. Find a safe and open area.
	9. Plan flight for flying field conditions.

AS3X™ Stabilization

DELIVERS BREAKTHROUGH PERFORMANCE

The AS3X System for airplanes is an electronic enhancement system that makes it possible for you to experience super-smooth flight performance, yet still have full control authority for sport, scale or 3D flight.

Turbulence, torque and tip stalls are just some of the many complications to assess when trying to achieve smooth flight. The Horizon Hobby world-class team of RC pilots developed the AS3X System for airplanes based on the successful use of AS3X with ultra micro flybarless helicopters. The AS3X System invisibly helps with complicated corrections,

allowing you to experience ultra-smooth flight performance that feels so natural that you'll quickly build confidence in the capability of the airplane.

AS3X system setup is easy. Just bind your DSM2™/DSMX® transmitter to the model using a basic airplane program and AS3X will assure that the locked-in feel and control authority you want is instantly at your command to help show off your RC pilot skills.

AS3X will innovate the way you'll want to fly now and in the future. To see what we mean, go to www.E-fliteRC.com/AS3X.

Low Voltage Cutoff (LVC)

When a Li-Po battery is discharged below 3V per cell, it will not hold a charge. The Beast 3D ESC protects the flight battery from over-discharge using Low Voltage Cutoff (LVC). Before the battery charge decreases too much, LVC removes power supplied to the motor. Power to the motor quickly decreases and increases, showing that some battery power is reserved for flight control and safe landing.

When the motor power pulses, land the aircraft immediately and recharge the flight battery.

Disconnect and remove the Li-Po battery from the aircraft after use to prevent trickle discharge. Before storage, charge the Li-Po battery to full capacity.

During storage, make sure the battery charge does not fall below 3V per cell.

Tip: Due to the quiet nature of the aircraft, you may not hear the pulsing of the motor.

For your first flights, set your transmitter timer or a stopwatch to five minutes. Adjust your timer for longer or shorter flights once you have flown the model.

NOTICE: Repeated flying to LVC will damage the battery.

Transmitter and Receiver Binding

Binding is the process of programming the receiver of the control unit to recognize the GUID (Globally Unique Identifier) code of a single specific transmitter. You need to 'bind' your chosen Spektrum™ DSM2™/DSMX® technology equipped aircraft transmitter to the receiver for proper operation.

Any JR® or Spektrum DSM2/DSMX transmitter can bind to the EFLU4864 receiver. Due to the aerobatic capabilities of the UMX Beast 3D, it is highly recommended that you use a transmitter with dual rates. Please visit www.bindnfly.com for a complete list of compatible transmitters.

NOTICE: When using a Futaba® transmitter with a Spektrum DSM module, reversing the throttle channel is required.

✓ Binding Procedure
1. Refer to your transmitter's unique instructions for binding to a receiver.
2. Make sure the flight battery is disconnected from the aircraft.
3. Power off your transmitter.
4. Connect the flight battery in the aircraft. The receiver LED will begin to flash rapidly. (Typically after 5 seconds).
5. Make sure transmitter controls are neutral and throttle and throttle trim are in low position.
6. Put your transmitter into bind mode. Refer to your transmitter's manual for binding button or switch instructions.
7. After five to 10 seconds, the receiver status LED will become solid, indicating that the receiver is bound to the transmitter. If the LED does not turn solid, refer to Troubleshooting Guide at back of manual.

For subsequent flights, power on the transmitter for 5 seconds before connecting the flight battery.

Installing the Flight Battery



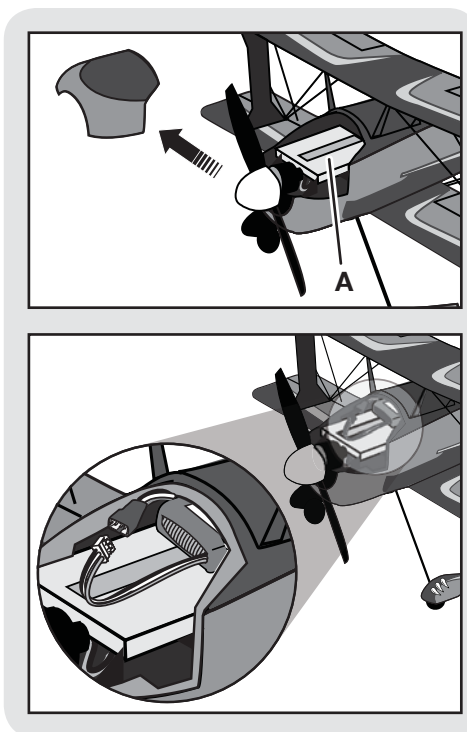

1. Remove the battery hatch from the nose of the aircraft.
2. Attach the flight battery to the hook and loop strip (A) on the battery tray. See the *Adjusting the Center of Gravity* instructions for the battery's position.
3. Place the aircraft on the ground out of the wind and connect a fully charged flight battery. **Ensure the aircraft is immobile for 5 seconds so the AS3X system initializes correctly.** See the *Arming the ESC* instructions for correct connection of the battery to the ESC.
4. Install the battery hatch.

NOTICE: If using a different battery than the recommended 2-Cell 7.4V 180mAh 20C Li-Po, you will need to apply a circle of hook and loop fastener to the back of the battery, opposite the side with the label, in order to hold the battery in place.

⚠ CAUTION: Always disconnect the Li-Po battery from the aircraft receiver when not flying to avoid over-discharging the battery. Batteries discharged to a voltage lower than the lowest approved voltage may become damaged, resulting in loss of performance and potential fire when batteries are charged.

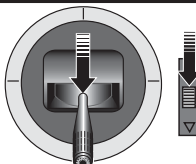
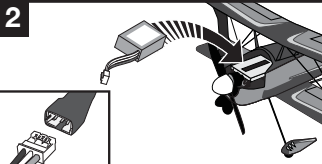
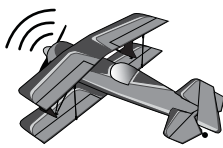

Arming the ESC

		
<p>1</p> <p>Lower throttle and throttle trim to lowest settings.</p> <p> Power on the Transmitter then wait 5 seconds.</p>	<p>2</p> <p>Install flight battery and connect it to the ESC.</p>	<p>3</p> <p> Keep plane immobile on its wheels away from wind for five seconds.</p> <p> Series of tones</p> <p> Continuous LED</p>

If you accidentally connect the battery while the throttle is fully raised, the ESC will enter programming mode. Disconnect the battery immediately.

The AS3X system will not activate until the throttle stick or trim is increased for the first time. Once the AS3X is active, the control surfaces may move rapidly on the aircraft. This is normal.

AS3X will remain active until the battery is disconnected.

 **CAUTION:** Always keep hands away from the propeller. When armed, the motor will turn the propeller in response to any throttle movement.

Control Direction Test

You should bind your aircraft and transmitter before doing these tests. Move the controls on the transmitter to make sure the aircraft control surfaces move correctly and in the proper direction.

Make sure all linkages move freely and that paint or decals are not adhered to them.

Control Centering

Before first flights, or in the event of an accident, make sure the flight control surfaces are centered. Adjust linkages mechanically if the control surfaces are not centered.

For best performance with AS3X, it is important that excessive trim is not used. If the model requires excessive trim, adjust the linkages and return the trim on the transmitter to neutral position.

Use of the transmitter sub-trims will not correctly center the aircraft control surfaces due to the mechanical limits of the linear servos.

1. Make sure the control surfaces are neutral when the transmitter controls and trims are centered. The transmitter sub-trim must be set to zero.

2. When needed, use a pair of pliers to carefully bend the metal of the control linkage (see illustration).
3. Make the U-shape narrower to make the connector shorter. Make the U-shape wider to make the linkage longer.

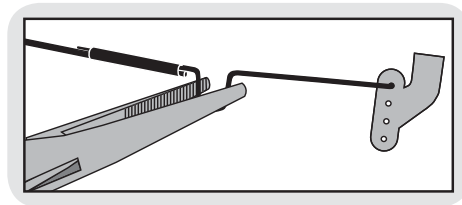

Settings for Control Horns

The following illustrations show linkage positions chosen for the most balanced aerobatic response. Linkage connections on the control horns directly affect aircraft response.

⚠ CAUTION: Extreme 3D flying is for advanced modelers. Using this setting without proper experience, could result in loss of control of your aircraft and a crash, causing damage to the aircraft and personal injury.

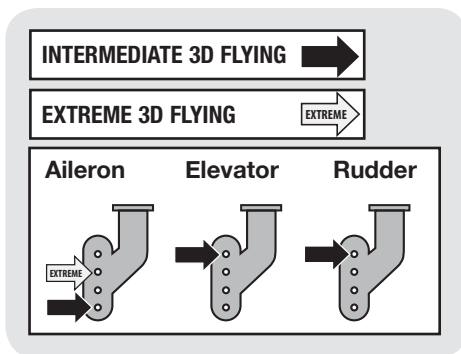

Dual Rates

We recommend using a DSM radio capable of dual rates due to the aerobatic capabilities of the Beast 3D. The settings below are recommended starting settings. Adjust according to individual preferences after the initial flight.

	High Rate	Low Rate
Aileron	100%	70%
Elevator	100%	70%
Rudder	100%	70%

NOTICE: DO NOT SET YOUR TRANSMITTER TRAVEL ADJUST OVER 100%. If the TRAVEL ADJUST is set over 100% it will not result in more control movement; it will overdrive the servo and cause damage.

It is normal for linear servos to make noise. Noise is not an indication of a faulty servo.

Adjusting Center of Gravity (CG)

The CG location is **19mm** back from the leading edge of the bottom wing at the root.

This CG location has been determined with the 2S 180mAh 7.4V Li-Po battery installed with the front edge of the battery aligned or slightly forward of the rear edge of the cowl.

The oversized battery tray allows for Center of Gravity adjustment. Start by placing the front edge of the battery aligned with or slightly forward of the rear edge of the cowl. Adjust as needed by sliding the battery back or forward. The wire length provides for either front-facing or rear-facing battery connection.

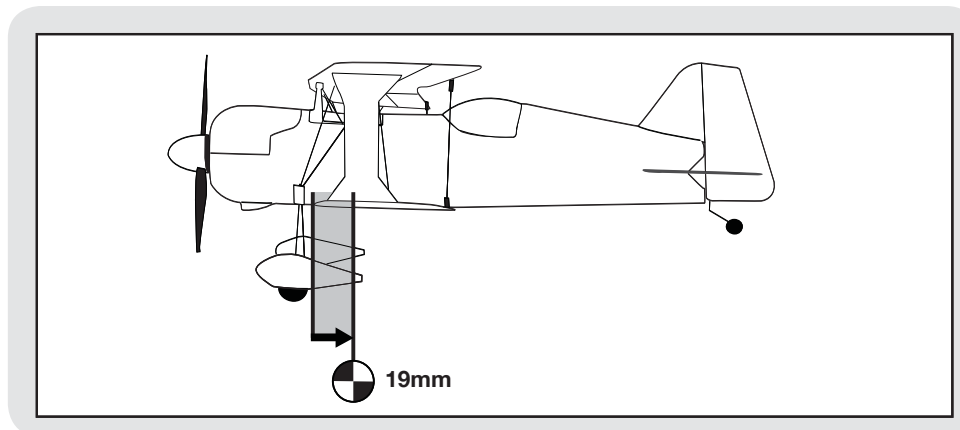

Flying Tips and Repairs

Flying

While the Beast 3D may be flown indoors in an open space such as a gymnasium, we recommend flying your Beast 3D outside in no greater than moderate winds. Always avoid flying near houses, trees, wires and buildings. You should also be careful to avoid flying in areas where there are many people, such as busy parks, schoolyards or soccer fields. Consult local laws and ordinances before choosing a location to fly your aircraft.

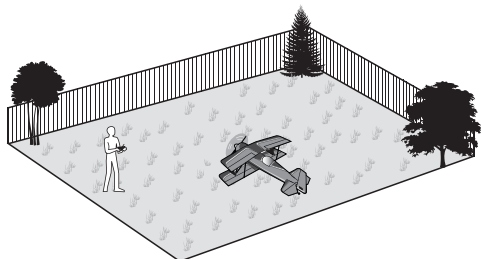

Place the Beast 3D in position for takeoff (facing into the wind if flying outdoors). Set dual rates to low position and gradually increase the throttle to $\frac{3}{4}$ to full and steer with the rudder. Pull back gently on the elevator and climb to check trim. Once the trim is adjusted, begin exploring the flight envelope of the Beast 3D.

Failure to lower the throttle stick and trim to the lowest possible positions during a crash could result in damage to the ESC in the receiver unit, which may require replacement.

The Beast 3D is equipped with Over Current Protection (OCP). This feature protects the ESC from overheating.

OCP stops the motor when the transmitter throttle is set too high and the propeller cannot turn. The OCP will only activate when the throttle stick is positioned just above $\frac{1}{2}$ throttle. After the ESC stops the motor, fully lower the throttle to re-arm the ESC.

NOTICE: Crash damage is not covered under warranty.

Repairs

Repair the Beast 3D using foam-compatible CA (cyanoacrylate adhesive) or clear tape. Only use foam-compatible CA, as other types of glue can damage the foam. When parts are not repairable, see the Replacement Parts List for ordering by item number.

For a listing of all replacement and optional parts, refer to the list at the back of this manual.

NOTICE: Use of foam-compatible CA accelerant on your model can damage paint. DO NOT handle model until accelerant fully dries.

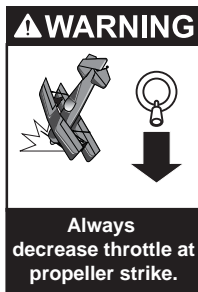

Additional Safety Precautions and Warnings

As the user of this product, you are solely responsible for operating in a manner that does not endanger yourself and others or result in damage to the product or the property of others.

This model is controlled by a radio signal subject to interference from many sources outside your control. This interference can cause momentary loss of control, so it is advisable to always keep a safe distance in all directions around your model, as this space will help avoid collisions or injury.

- Always keep a safe distance in all directions around your model to avoid collisions or injury.
- Always operate your model in open spaces away from full-size vehicles, traffic and people.
- Always carefully follow the directions and warnings for this and any optional support equipment (chargers, rechargeable battery packs, etc.).
- Always keep all chemicals, small parts and anything electrical out of the reach of children.
- Always avoid water exposure to all equipment not specifically designed and protected for this purpose. Moisture causes damage to electronics.
- Never place any portion of the model in your mouth as it could cause serious injury or even death.
- Never operate your model with low transmitter batteries.

Post Flight Checklist

✓	
	1. Disconnect flight battery from ESC (Required for Safety and battery life).
	2. Power off transmitter.
	3. Remove flight battery from aircraft.
	4. Recharge flight battery.

✓	
	5. Store flight battery apart from aircraft and monitor the battery charge.
	6. Make note of flight conditions and flight plan results, planning for future flights.

Service of Power Components

Disassembly

⚠ CAUTION: DO NOT handle propeller parts while the flight battery is connected. Personal injury could result.

Propeller

1. Remove the battery hatch by gripping the front of the hatch, then pulling it up and away from the fuselage.
2. Carefully loosen screw (A) inside the spinner, then remove the propeller assembly (B) from the motor shaft (C).
3. Remove the spinner (D) and glue from the backplate (E) to free the propeller (F) and backplate. The motor magnet may attract screws to the motor.

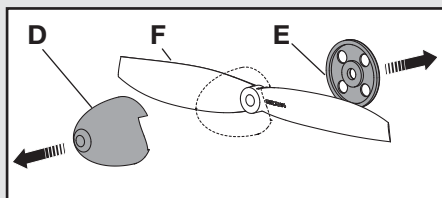
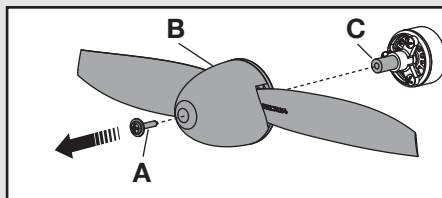

Motor and Firewall

1. Remove 2 screws (G), the firewall (H) and motor (I) from the fuselage motor mount (J).
2. Remove the top screw (K) from the firewall (H) and motor (I).
3. Disconnect the motor wire connector from the ESC/receiver connector.

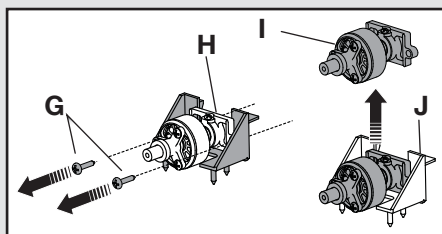

Assembly

Motor and Firewall

1. Connect the motor wire connector to the ESC/receiver connector so the wire colors align.
2. Install the motor in the firewall using a screw in the top of the firewall.
3. Attach the firewall to the fuselage motor mount using 2 screws.

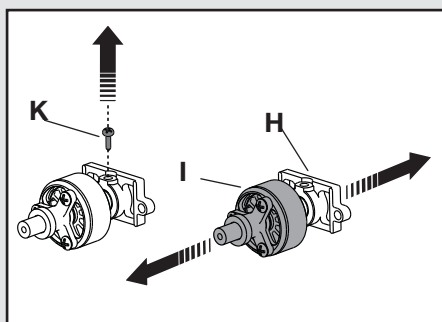

Propeller

1. Install the backplate and propeller on the motor shaft using a screw. The numbers on the propeller must face out from the fuselage for correct propeller operation.
2. Install the spinner on the propeller and backplate using foam-compatible CA.
3. Put the foam battery hatch on the fuselage and slide it back to fully engage the fuselage.

When the fuselage must be opened for access to servos or receiver, first cut the tape or decals before opening the canopy hatch.

Removing tape or decals may remove paint from the fuselage.

Troubleshooting Guide

AS3X

Problem	Possible Cause	Solution
Control surfaces are not at neutral position when transmitter controls are at neutral	Control surfaces may not have been mechanically centered from factory	Center control surfaces mechanically by adjusting the U-bends on control linkages
	Aircraft was moved after the flight battery was connected and before sensors initialized	Disconnect flight battery and reconnect while being sure model does not move for 5 seconds
Model flies inconsistently from flight to flight	Trims are moved too far from neutral position	Neutralize trims and mechanically adjust linkages to center control surfaces

Problem	Possible Cause	Solution
Aircraft will not respond to throttle but responds to other controls	Throttle stick and/or throttle trim too high	Reset controls with throttle stick and throttle trim at lowest setting
	Throttle channel is reversed	Reverse throttle channel on transmitter
	Motor disconnected from receiver	Open fuselage and make sure motor is connected to the receiver
Extra propeller noise or extra vibration	Damaged propeller, spinner or motor	Replace damaged parts
	Prop screw is too loose	Tighten the prop screw
Reduced flight time or aircraft underpowered	Flight battery charge is low	Completely recharge flight battery
	Propeller installed backwards	Install propeller with numbers facing forward
	Flight battery damaged	Replace flight battery and follow flight battery instructions
	Flight conditions may be too cold	Make sure battery is warm before use
LED on receiver flashes and aircraft will not bind to transmitter (during binding)	Battery capacity too low for flight conditions	Replace battery or use a larger capacity battery
	Transmitter too near aircraft during binding process	Power off transmitter, move transmitter a larger distance from aircraft, disconnect and reconnect flight battery to aircraft and follow binding instructions
LED on receiver flashes rapidly and aircraft will not respond to transmitter (after binding)	Bind switch or button not held long enough during bind process	Power off transmitter and repeat bind process. Hold transmitter bind button or switch until receiver is bound
	Less than a 5-second wait between first powering on transmitter and connecting flight battery to aircraft	Leave transmitter on, disconnect and reconnect flight battery to aircraft
	Aircraft bound to different model memory (ModelMatch™ radios only)	Select correct model memory on transmitter and disconnect and reconnect flight battery to aircraft
	Flight battery/transmitter battery charge is too low	Replace/recharge batteries

Troubleshooting Guide (Continued)

Problem	Possible Cause	Solution
Control surface does not move	Control surface, control horn, linkage or servo damage	Replace or repair damaged parts and adjust controls
	Wire damaged or connections loose	Check wires and connections, connect or replace as needed
	Flight battery charge is low	Fully recharge flight battery
	Control linkage does not move freely	Make sure control linkage moves freely
Controls reversed	Transmitter settings reversed	Perform Control Direction Test and adjust controls on transmitter appropriately
Motor loses power	Damage to motor or power components	Check motor and power components for damage (replace as needed)
Motor power quickly decreases and increases then motor loses power	Battery power is down to the point of receiver/ESC Low Voltage Cutoff (LVC)	Recharge flight battery or replace battery that is no longer performing
Motor/ESC is not armed after landing	Over Current Protection (OCP) stops the motor when the transmitter throttle is set high and the propeller cannot turn	Fully lower throttle and throttle trim to arm ESC
Servo locks or freezes at full travel	Travel adjust value is set above 100% overdriving the servo	Set Travel adjust to 100% or less and/or set sub-trims to Zero and adjust linkages mechanically.

Warranty and Repair Policy

What this Warranty Covers

Horizon Hobby, Inc. ("Horizon") warrants to the original purchaser that the product purchased (the "Product") will be free from defects in materials and workmanship at the date of purchase.

What is Not Covered

This warranty is not transferable and does not cover (i) cosmetic damage, (ii) damage due to acts of God, accident, misuse, abuse, negligence, commercial use, or due to improper use, installation, operation or maintenance, (iii) modification of or to any part of the Product, (iv) attempted service by anyone other than a Horizon Hobby authorized service center, or (v) Products not purchased from an authorized Horizon dealer.

OTHER THAN THE EXPRESS WARRANTY ABOVE, HORIZON MAKES NO OTHER WARRANTY OR REPRESENTATION, AND HEREBY DISCLAIMS ANY AND ALL IMPLIED WARRANTIES, INCLUDING, WITHOUT LIMITATION, THE IMPLIED WARRANTIES OF NON-INFRINGEMENT, MERCHANTABILITY AND FITNESS FOR A PARTICULAR PURPOSE. THE PURCHASER ACKNOWLEDGES THAT THEY ALONE HAVE DETERMINED THAT THE PRODUCT WILL SUITABLY MEET THE REQUIREMENTS OF THE PURCHASER'S INTENDED USE.

Purchaser's Remedy

Horizon's sole obligation and purchaser's sole and exclusive remedy shall be that Horizon will, at its option, either (i) service, or (ii) replace, any Product determined by Horizon to be defective. Horizon reserves the right to inspect any and all Product(s) involved in a warranty claim. Service or replacement decisions are at the sole discretion of Horizon. Proof of purchase is required for all warranty claims. SERVICE OR REPLACEMENT AS PROVIDED UNDER THIS WARRANTY IS THE PURCHASER'S SOLE AND EXCLUSIVE REMEDY.

Limitation of Liability

HORIZON SHALL NOT BE LIABLE FOR SPECIAL, INDIRECT, INCIDENTAL OR CONSEQUENTIAL DAMAGES, LOSS OF PROFITS OR PRODUCTION OR COMMERCIAL LOSS IN ANY WAY, REGARDLESS OF WHETHER SUCH CLAIM IS BASED IN CONTRACT, WARRANTY, TORT, NEGLIGENCE, STRICT LIABILITY OR ANY OTHER THEORY OF LIABILITY, EVEN IF HORIZON HAS BEEN ADVISED OF THE POSSIBILITY OF SUCH DAMAGES. Further, in no event shall the liability of Horizon exceed the individual price of the Product on which liability is asserted. As Horizon has no control over use, setup, final assembly, modification or misuse, no liability shall be assumed nor accepted for any resulting damage or injury. By the act of use, setup or assembly, the user accepts all resulting liability. If you as the purchaser or user are not prepared to accept the liability associated with the use of the Product, purchaser is advised to return the Product immediately in new and unused condition to the place of purchase.

Law

These terms are governed by Illinois law (without regard to conflict of law principals). This warranty gives you specific legal rights, and you may also have other rights which vary from state to state. Horizon reserves the right to change or modify this warranty at any time without notice.

Warranty Services

Questions, Assistance, and Services

Your local hobby store and/or place of purchase cannot provide mwarranty support or service. Once assembly,

setup or use of the Product has been started, you must contact your local distributor or Horizon directly. This will enable Horizon to better answer your questions and ervice you in the event that you may need any assistance. For questions or assistance, please direct your email to productsupport@horizonhobby.com, or call 877.504.0233 toll free to speak to a Product Support representative. You may also find information on our website at www.horizonhobby.com.

Inspection or Services

If this Product needs to be inspected or serviced, please use the Horizon Online Service Request submission process found on our website or call Horizon to obtain a Return Merchandise Authorization (RMA) number. Pack the Product securely using a shipping carton. Please note that original boxes may be included, but are not designed to withstand the rigors of shipping without additional protection. Ship via a carrier that provides tracking and insurance for lost or damaged parcels, as Horizon is not responsible for merchandise until it arrives and is accepted at our facility. An Online Service Request is available at www.horizonhobby.com under the Support tab. If you do not have internet access, please contact Horizon Product Support to obtain a RMA number along with instructions for submitting your product for service. When calling Horizon, you will be asked to provide your complete name, street address, email address and phone number where you can be reached during business hours. When sending product into Horizon, please include your RMA number, a list of the included items, and a brief summary of the problem. A copy of your original sales receipt must be included for warranty consideration. Be sure your name, address, and RMA number are clearly written on the outside of the shipping carton.

Notice: Do not ship LiPo batteries to Horizon. If you have any issue with a LiPo battery, please contact the appropriate Horizon Product Support office.

Warranty Requirements

For Warranty consideration, you must include your original sales receipt verifying the proof-of-purchase date. Provided warranty conditions have been met, your Product will be serviced or replaced free of charge. Service or replacement decisions are at the sole discretion of Horizon.

Non-Warranty Service

Should your service not be covered by warranty service will be completed and payment will be required without notification or estimate of the expense unless the expense exceeds 50% of the retail purchase cost. By submitting the item for service you are agreeing to payment of the service without notification. Service estimates are available upon request. You must include this request with your item submitted for service. Non-warranty service estimates will be billed a minimum of ½ hour of labor. In addition you will be billed for return freight. Horizon accepts money orders and cashiers checks, as well as Visa, MasterCard, American Express, and Discover cards. By submitting any item to Horizon for service, you are agreeing to Horizon's Terms and Conditions found on our website www.horizonhobby.com/Service/Request/.

Warranty and Service Information

Country of Purchase	Horizon Hobby	Address	Phone Number/Email Address
United States of America	Horizon Service Center (Electronics and engines)	4105 Fieldstone Rd Champaign, Illinois 61822 USA	877-504-0233 Online Repair Request visit: www.horizonhobby.com/service
	Horizon Product Support (All other products)	4105 Fieldstone Rd Champaign, Illinois 61822 USA	877-504-0233 productsupport@horizonhobby.com
United Kingdom	Horizon Hobby Limited	Units 1-4 Ployters Rd Staple Tye Harlow, Essex CM18 7NS United Kingdom	+44 (0) 1279 641 097 sales@horizonhobby.co.uk
Germany	Horizon Technischer Service	Christian-Junge-Straße 1 25337 Elmshorn Germany	+49 (0) 4121 2655 100 service@horizonhobby.de
France	Horizon Hobby SAS	14 Rue Gustave Eiffel Zone d'Activité du Réveil Matin 91230 Montgeron	+33 (0) 1 60 47 44 70 infofrance@horizonhobby.com

Compliance Information for the European Union

Declaration of Conformity

(in accordance with ISO/IEC 17050-1)
No. HH2011093005

Product(s): UMX Beast 3D BNF Basic
Item Number(s): EFLU4850
Equipment class: 1

The object of declaration described above is in conformity with the requirements of the specifications listed below, following the provisions of the European R&TTE directive 1999/5/EC:

EN 301 489-1 V1.7.1: 2006
EN 301 489-17 V1.3.2: 2008



Signed for and on behalf of:
Horizon Hobby, Inc.
Champaign, IL USA
Sep 30, 2011

Steven A. Hall
Vice President
International Operations and Risk Management
Horizon Hobby, Inc.

Instructions for disposal of WEEE by users in the European Union



This product must not be disposed of with other waste. Instead, it is the user's responsibility to dispose of their waste equipment by handing it over to a designated collections point for the recycling of waste electrical and electronic equipment. The separate collection and recycling of your waste equipment at the time of disposal will help to conserve natural resources and ensure that it is recycled in a manner that protects human health and the environment. For more information about where you can drop off your waste equipment for recycling, please contact your local city office, your household waste disposal service or where you purchased the product.

– Parts Contact Information –
– Intaktinformationen für Ersatzteile –
– Coordonnés pour obtenir de pièces détachées –
– Recapiti per i ricambi –

Country of Purchase	Horizon Hobby	Address	Phone Number/Email Address
United States	Sales	4105 Fieldstone Rd Champaign, Illinois, 61822 USA	800-338-4639 sales@horizonhobby.com
United Kingdom	Horizon Hobby Limited	Units 1-4 Ployters Rd Staple Tye Harlow, Essex CM18 7NS, United Kingdom	+44 (0) 1279 641 097 sales@horizonhobby.co.uk
Germany	Horizon Hobby GmbH	Christian-Junge-Straße 1, 25337 Elmshorn, Germany	+49 (0) 4121 2655 100 service@horizonhobby.de
France	Horizon Hobby SAS	14 Rue Gustave Eiffel Zone d'Activité du Réveil Matin 91230 Montgeron	+33 (0) 1 60 47 44 70 infofrance@horizonhobby.com

– Replacement Parts –
– Ersatzteile –
– Pièces de rechange –
– Ricambi –

Part # • Nummer Numéro • Codice	Description	Beschreibung	Description	Descrizione
EFLU4859	Wing Set: UMX Beast 3D	Tragflächenset: UMX Beast 3D	Aile: UMX Beast 3D	Set ala: UMX Beast 3D
EFLU4064	Cabane: UMX Beast	Tragflächenstreben: UMX Beast 3D	Cabane: UMX Beast	Cabana: UMX Beast
EFLU4858	Fuselage Set: UMX Beast 3D	Rumpf: UMX Beast 3D	Fuselage: UMX Beast 3D	Set fusoliera: UMX Beast 3D
EFLU4860	Tail Surface set: UMX Beast 3D	Leitwerksset: UMX Beast 3D	Empennage: UMX Beast 3D	Set piani di coda: UMX Beast 3D
EFLU4854	Wheel Pants Set: UMX Beast 3D	Radschuhe: UMX Beast 3D	Chapeaux de roues: UMX Beast 3D	Set carenatura ruote: UMX Beast 3D
EFLU4055	Landing Gear with Wheels: UMX Beast	Fahrwerk mit Rädern: UMX Beast 3D	Chapeaux de roues: UMX Beast	Carrello con ruote: UMX Beast
EFLU4862	Battery Hatch: UMX Beast 3D	Akkuklappe : UMX Beast 3D	Capot: UMX Beast 3D	Coperchio batteria: UMX Beast 3D
EFLU4865	Decal Set: UMX Beast 3D	Dekorbögen: UMX Beast 3D	Planche de décoration: UMX Beast 3D	Set adesivi: UMX Beast 3D
EFLU4863	Canopy hatch: UMX Beast 3D	Kabinenhaube: UMX Beast 3D	Verrière: UMX Beast 3D	Coperchio capottina: UMX Beast 3D
EFLUP0503	5x2.75 Electric pro- peller: UMX Beast	5 x 2,75: UMX Beast	5x2.75 Hélice élec- trique: UMX Beast	Elica 5x2,75: UMX Beast
EFLUM180BL2	BL180 Brushless Outrunner Motor, 2500Kv	BL180 Brushless Außenläufer Motor, 2500Kv	BL180 Brushless à cage tournante, 2500Kv	BL180 motore brush- less a cassa rotante, 2500Kv
EFLUB1802S20	180mAh 2S 7.4V 20C Li-Po, 26AWG	180mAh 2S 7.4V 20C Li-Po Akku	180mAh 2S 7.4V 20C Li-Po, 26AWG	180mAh 2S 7.4V 20C Li-Po, 26AWG
EFLU4851	Spinner: UMX Beast 3D	Spinner: UMX Beast 3D	Cône: UMX Beast 3D	Ogiva: UMX Beast 3D

Part # • Nummer Numéro • Codice	Description	Beschreibung	Description	Descrizione
EFLU4066	Firewall: UMX Beast	Brandschott UMX Beast	Support moteur: UMX Beast	Ordinata: UMX Beast
EFLU4067	Prop Adaptor: UMX Beast	Prop Adaptor: UMX Beast	Adaptateur d'hélice: UMX Beast	Adattatore elica: UMX Beast
EFLUC1007	Celectra 2S 7.4V DC Li-Po Charger	Celectra 2S 7.4V DC Li-Po Ladegerät	Chargeur Celectra DC 7.4V 2S	Celectra 2S 7.4V DC Caricabatterie Li-Po
EFLUC1008	Power Cord for EFLUC1007	Anschlußstecker mit Krokodilklemmen für EFLUC1007	Câble d'alimentation EFLUC1007	Cavo alimentazione per EFLUC1007
EFLU4061	Carbon Rods Set: UMX Beast	E-flite UMX Beast Anlenkungen Carbon	Set de biellettes carbone: UMX Beast	Set aste in carbonio: UMX Beast
EFLU4046	Pushrod Set: UMX Beast	Gestänge Set UMX Beast	Set de tringleries: UMX Beast	Set rinvii: UMX Beast
EFLU4864	DSM2 6 Ch Ultra Micro AS3X Receiver BL-ESC	DSM2 6 Kanal Ultra Micro AS3X Empfänger BL-ESC	Ultra micro récepteur 6voies DSM2 AS3X a avec contrôleur brushless intégré.	DSM2 6 Ch Ultra Micro AS3X Ricevitore BL-ESC
SPMSA2030L	2.3-Gram Performance Linear Long Throw Servo	2,3 Gramm Hochleistungs - Linear Servo mit langem Ruderweg	Servo 2.3g linéaire longue course performant	Ottimo servo lineare a corsa lunga da 2,3 Grammi
SPM6836	Replacement Servo Mechanics: Ultra Micro Long Throw	Austausch Servo Mechanik: Ultra Micro Long Throw	Mécanique de remplacement pour servo: Ultra micro longue course	Meccanica ricambio per servo: Ultra Micro Long Throw
EFLU4070	Replacement Servo Retaining Collars: MCX/2/MSR	Ersatz Stellringe MCX/MSR	Colliers de servo: MCX/2/MSR	Collari di fissaggio per servo: MCX/2/MSR
EFLU4069	Interplane Strut Set: UMX Beast	Tragflächenstreben	Set de haubans: UMX Beast	Set montanti alari: UMX Beast

– Optional Parts and Accessories –
– Optionale Bauteile und Zubehörteile –
– Pièces optionnelles et accessoires –
– Parti opzionali e accessori –

Part # • Nummer Numéro • Codice	Description	Beschreibung	Description	Descrizione
EFLA700UM	Charger Plug Adapter: EFL	Ladekabel Adapter EFL	Prise d'adaptation chargeur: EFL	Adattatore per la carica: EFL
EFLA7001UM	Charger Plug Adapter: TP	Ladekabel Adapter TP	Prise d'adaptation chargeur: TP	Adattatore per la carica: TP
EFLU4068	Harness Adapter: UMX Beast	E-flite UMX Beast Y-Kabel	Adaptateur de câblage: UMX Beast	Cavo adattatore: UMX Beast
SPM6825	AS2000 Servo Reverser	E-flite UMX Beast Y-Kabel	AS2000 Inverseur de servo	AS2000 Inversore per servo
ELFC4000	AC to 12V DC, 1.5 Amp Power Supply (US)	AC to 12V DC, 1.5 Amp Power Supply (US)	Alimentation secteur 12V DC 1.5A (US)	AC to 12V DC, 1.5 Alimentatore (US)
EFLC4000UK	AC to 12V DC, 1.5 Amp Power Supply (UK)	AC to 12V DC, 1.5 Amp Power Supply (UK)	Alimentation secteur 12V DC 1.5A (UK)	AC to 12V DC, 1.5 Alimentatore (UK)
EFLC4000AU	AC to 12V DC, 1.5 Amp Power Supply (AU)	AC to 12V DC, 1.5 Amp Power Supply (AU)	Alimentation secteur 12V DC 1.5A (AU)	AC to 12V DC, 1.5 Alimentatore (AU)
EFLC4000EU	AC to 12V DC, 1.5 Amp Power Supply (EU)	AC to 12V DC, 1.5 Amp Netzgerät (EU)	Alimentation secteur 12V DC 1.5A (EU)	AC to 12V DC, 1.5 Alimentatore (EU)
SPMR4400	DX4e DSMX 4-Channel Transmitter Mode 2/4	Spektrum DX4e 4 Kanal Sender ohne Empfänger MD 2/4	Emetteur DX4e DSMX 4 voies Mode 2/4	DX4e DSMX Trasmettitore 4 canali Mode 2/4
SPMR44001	DX4e DSMX 4-Channel Full Range Transmitter Mode 1/3	Spektrum DX4e 4 Kanal Sender ohne Empfänger MD 1/3	Emetteur DX4e DSMX 4 voies Mode 1/3	DX4e DSMX Trasmettitore 4 canali Mode 1/3
SPMR5510	DX5e DSMX 5-channel Transmitter Mode 2	Spektrum DX5E DSMX 5 Kanalsender ohne Empfänger MD 2	Emetteur DX5e DSMX 5 voies Mode 2	DX5e DSMX Trasmettitore 5 canali Mode 2
SPMR55101	DX5e DSMX 5-channel Transmitter Mode 1	Spektrum DX5E DSMX 5 Kanalsender ohne Empfänger MD 1	Emetteur DX5e DSMX 5 voies Mode 1	DX5e DSMX Trasmettitore 5 canali Mode 1
SPMR6610	DX6i DSMX 6-Channel Transmitter Mode 2	DX6i DSMX 6-Kanal Sender Mode 2	Emetteur DX6i DSMX 6 voies Mode 2	DX6i DSMX Trasmettitore 6 canali Mode 2
SPMR66101	DX6i DSMX 6-Channel Transmitter Mode 1	DX6i DSMX 6-kanal Sender Mode 1	Emetteur DX6i DSMX 6 voies Mode 1	DX6i DSMX Trasmettitore 6 canali Mode 1
SPMR6610E	DX6i DSMX 6-Channel Transmitter Mode 2 (EU)	Spektrum DX6i DSM X Sender ohne Empfänger MD2	Emetteur DX6i DSMX 6 voies Mode 2 (EU)	DX6i DSMX Trasmettitore 6 canali Mode 2 (EU)
SPMR66101E	DX6i DSMX 6-Channel Transmitter Mode 1 (EU)	Spektrum DX6i DSMX Sender ohne Empfänger MD1	Emetteur DX6i DSMX 6 voies Mode 1 (EU)	DX6i DSMX Trasmettitore 6 canali Mode 1 (EU)

Part # • Nummer Numéro • Codice	Description	Beschreibung	Description	Descrizione
SPM7800	DX7s DSMX 7-Channel Transmitter Mode 2	Spektrum DX7s 7 Kanal Sender	Emetteur DX7s DSMX 7 voies Mode 2	DX7s DSMX Trasmittitore 7 canali Mode 2
SPM7800EU	DX7s DSMX 7-Channel Transmitter Mode 2 (EU)	Spektrum DX7s 7 Kanal Sender	Emetteur DX7s DSMX 7 voies Mode 2 (EU)	DX7s DSMX Trasmittitore 7 canali Mode 2 (EU)
SPM78001AU	DX7s DSMX 7-Channel Transmitter Mode 1 (AU)	DX7s DSMX 7-Channel Transmitter Mode 1 (AU)	Emetteur DX7s DSMX 7 voies Mode 1 (AU)	DX7s DSMX Trasmittitore 7 canali Mode 1 (AU)
SPM78001EU	DX7s DSMX 7-Channel Transmitter Mode 1 (EU)	Spektrum DX7s 7 Kanal Sender Mode 1 (EU)	Emetteur DX7s DSMX 7 voies Mode 1 (EU)	DX7s DSMX Trasmittitore 7 canali Mode 1 (EU)
*SPMR8800	DX8 DSMX Transmitter Only Mode 2	Spektrum DX8 nur Sender Mode 1-4	Emetteur DX8 DSMX 8 voies Mode 2	DX8 DSMX Solo trasmittitore Mode 2
*SPMR8800EU	DX8 DSMX Transmitter Only Mode 2 (EU)	Spektrum DX8 nur Sender Mode 1-4	Emetteur DX8 DSMX 8 voies Mode 2 (EU)	DX8 DSMX Solo trasmittitore Mode 2 (EU)
*SPMR88001AU	DX8 DSMX Transmitter Only Mode 1 AU	DX8 DSMX Transmitter Only Mode 1 AU	Emetteur DX8 DSMX 8 voies Mode 1	DX8 DSMX Solo trasmittitore Mode 1 AU
*SPMR88001EU	DX8 DSMX Transmitter Only Mode 1 (EU)	DX8 DSMX Transmitter Only Mode 1 EU	Emetteur DX8 DSMX 8 voies Mode 1 (EU)	DX8 DSMX Solo trasmittitore Mode 1 (EU)

* All Spektrum DX8 transmitters can be set up for modes 1–4

* Alle Spektrum DX8 Sender können für Mode 1–4 eingestellt werden

* Tous les émetteurs Spektrum DX8 peuvent être paramétrés dans les 4 modes

* Tutti i trasmettitori Spektrum DX8 possono essere configurati per i modi 1–4

© 2012 Horizon Hobby, Inc.

E-flite, AS3X, UMX, JR, Celectra, DSM2, DSMX and ModelMatch are trademarks or registered trademarks of Horizon Hobby, Inc.

The Spektrum trademark is used with permission of Bachmann Industries, Inc.

Beast® and its design are either registered trademarks or trademarks of Kevin Kimball, used under license to Horizon Hobby, Inc. The trim scheme of the Beast® was designed by Mirco Pecorari of Aircraft Studio Design.

Futaba is a registered trademark of Futaba Denshi Kogyo Kabushiki Kaisha Corporation of Japan.

US D578,146. PRC ZL 200720069025.2. US 7,898,130. Other patents pending.

www.e-fliterc.com

